

LIGO Laboratory / LIGO Scientific Collaboration

LIGO- E1000309

LIGO

June 8th, 2011

**aLIGO HAM-ISI, Pre-integration Testing procedure,
Phase I (post-assembly, before storage)**

E1000309 – V7

Ben Abbott, Eric Allwine, Corey Gray, Celine Ramet, Michael Vargas
Vincent Lhuillier, Fabrice Matchard, Hugh Radkins, Jim Warner, Richard Mittleman

Distribution of this document:
Advanced LIGO Project

This is an internal working note
of the LIGO Laboratory

California Institute of Technology
LIGO Project – MS 18-34
1200 E. California Blvd.
Pasadena, CA 91125
Phone (626) 395-2129
Fax (626) 304-9834
E-mail: info@ligo.caltech.edu

LIGO Hanford Observatory
P.O. Box 1970
Mail Stop S9-02
Richland WA 99352
Phone 509-372-8106
Fax 509-372-8137

Massachusetts Institute of Technology
LIGO Project – NW22-295
185 Albany St
Cambridge, MA 02139
Phone (617) 253-4824
Fax (617) 253-7014
E-mail: info@ligo.mit.edu

LIGO Livingston Observatory
P.O. Box 940
Livingston, LA 70754
Phone 225-686-3100
Fax 225-686-7189

Table of contents:

- Introduction..... 4
- I. Pre-Assembly Testing..... 5
 - Step 1: Position Sensors..... 5
 - Step 2: GS13 7
 - Step 3: Actuators..... 7
- II. Tests to be performed during assembly 8
 - Step 1: Inventory (E1000052)..... 8
 - Step 2: Check torques on all bolts..... 8
 - Step 3: Check gaps under Support Posts..... 9
 - Step 4: Pitchfork/Boxwork flatness before Optical Table install 10
 - Step 5: Blade spring profile 11
 - Step 6: Gap checks on actuators-after installation on Stage 1 12
 - Step 7: Check level of Stage 0 13
 - Step 8: Check level of Stage 1 Optical Table 14
 - Step 9: Mass budget..... 15
 - Step 10: Shim thickness 17
 - Step 11: Lockers adjustment..... 17
- III. Tests to be performed after assembly 19
 - MEDM set-up for testing 19
 - Step 1 - Electronics Inventory..... 20
 - Step 2 - Set up sensors gap 21
 - Step 3 - Measure the Sensor gap..... 23
 - Step 4 - Check Sensor gaps after the platform release..... 24
 - Step 5 – Performance of the limiter 25
 - Step 5.1 - Test N°1 - Push “in the general coordinates” 25
 - Step 5.2 - Test N°2 – Push “locally” 26
 - Step 6 - Position Sensors unlocked/locked Power Spectrum..... 27
 - Step 7 - GS13 power spectrum -tabled tilted 29
 - Step 8- GS13 pressure readout..... 31
 - Step 9 - Coil Driver, cabling and resistance check 32
 - Step 10 - Actuators Sign and range of motion (Local drive)..... 34
 - Step 11 - Vertical Sensor Calibration 35
 - Step 12 - Vertical Spring Constant 37
 - Step 13 - Static Testing (Tests in the local basis) 38
 - Step 14 - Linearity test..... 40
 - Step 15 - Cartesian Basis Static Testing 42
 - Step 16- Frequency response 44
 - Step 16.1 - Local to local measurements 47
 - Step 16.2 - Cartesian to Cartesian measurements 48
 - Step 17 - Transfer function comparison with Reference 51
 - Step 17.1 - Local to local - Comparison with Reference..... 51
 - Step 17.2 - Cartesian to Cartesian - Comparison with Reference..... 51
 - Step 18 - Lower Zero Moment Plane..... 53
 - Step 19 - Damping loops..... 55
 - Step 19.1 - Transfer functions - Simulation..... 55
 - Step 19.2 - Powerspectra – Experimental 57

Appendix A: Dial indicators location 59
Appendix B: Sensor calibration 61
Appendix C: SVN arborescence 62
Appendix D: Matrices 63

Introduction

The HAM-ISI testing will be made in three phase:

- 1) HAM-ISI, Pre-integration Testing, Phase I (post-assembly, before storage)
- 2) HAM-ISI, Pre-integration Testing, Phase II : Final tests done after storage and before insertion
- 3) HAM-ISI, Integration Phase Testing: Procedure and results related to the commissioning in the chamber.

This document describes the test to be done on the **HAM-ISI Pre-integration Testing, Phase I**. All the units have to be tested per this procedure prior storage. Due to the several procedure releases, each Test reports must mentioned the procedure version used during testing.

Tests reports and results for each unit, including the data (one test report per HAM-ISI):

- E1000310, aLIGO HAM-ISI, Pre-integration Test Report, Phase I, LHO Unit #1.
- E1000311, aLIGO HAM-ISI, Pre-integration Test Report, Phase I, LHO Unit #2.
- E1000312, aLIGO HAM-ISI, Pre-integration Test Report, Phase I, LHO Unit #3.
- E1000313, aLIGO HAM-ISI, Pre-integration Test Report, Phase I, LHO Unit #4.
- E1000314, aLIGO HAM-ISI, Pre-integration Test Report, Phase I, LHO Unit #5.
- E1000323, aLIGO HAM-ISI, Pre-integration Test Report, Phase I, LHO Unit #6.
- E1000324, aLIGO HAM-ISI, Pre-integration Test Report, Phase I, LHO Unit #7.

- E1000325, aLIGO HAM-ISI, Pre-integration Test Report, Phase I, LLO Unit #1.
- E1000326, aLIGO HAM-ISI, Pre-integration Test Report, Phase I, LLO Unit #2.
- E1000327, aLIGO HAM-ISI, Pre-integration Test Report, Phase I, LLO Unit #3.
- E1000328, aLIGO HAM-ISI, Pre-integration Test Report, Phase I, LLO Unit #4.
- E1000329, aLIGO HAM-ISI, Pre-integration Test Report, Phase I, LLO Unit #5.
- E1000330, aLIGO HAM-ISI, Pre-integration Test Report, Phase I, LLO Unit #6.
- E1000331, aLIGO HAM-ISI, Pre-integration Test Report, Phase I, LLO Unit #7.

SVN

- Excell spreadsheet (.xls)
- SVN Masses distribution scheme (ppt)

DCC documents

- E1000300 HAM-ISI LLO test stand software check
- E1000052 aLIGO HAM-ISI Assembly Serial Number Registration
- T1100261 aLIGO SEI Testing, HAM-ISI, Weight Recording Example
- E1100427 aLIGO SEI Testing, HAM-ISI, Results Compilations

Notes:

- Useful information such as **sign conventions or calibration numbers are highlighted in green**.
- This is a living document. If you modifications or corrections are needed, they should be carried on, provided that their validity is checked.

I. Pre-Assembly Testing

- *Step 1: Position Sensors*

Set up the offset on the jig. The test jig is shown on the picture below. Shim washers are used to set up the gap between the position sensor and the jig. A caliper is used to measure the jig cutout depth and the shims thickness.

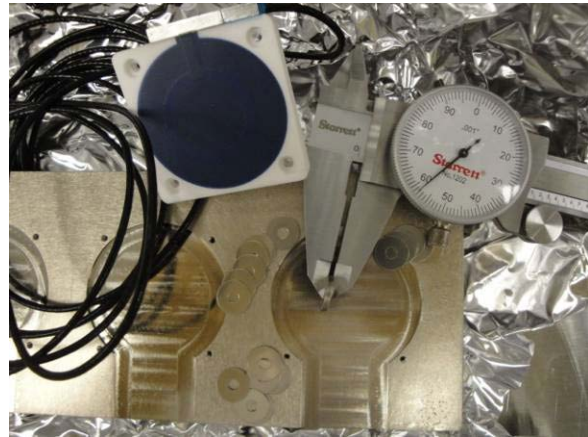

6 shims are measured at 0.058". The cutout in the jig is 0.030" deep. The sensor extends out approximately 0.007" away from the surface where the shims are placed. So the gap is set up to be 0.081" nominal.

Position sensors and shim washers prior installation:

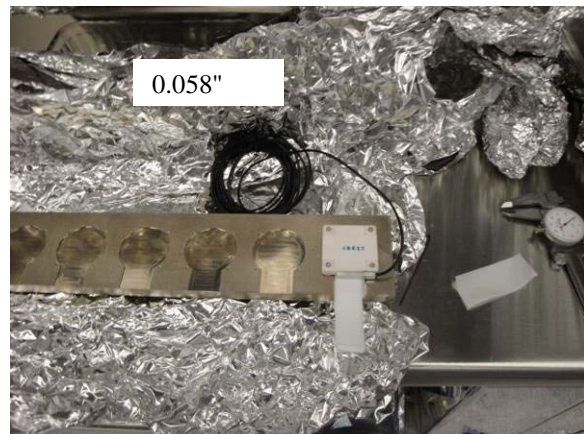
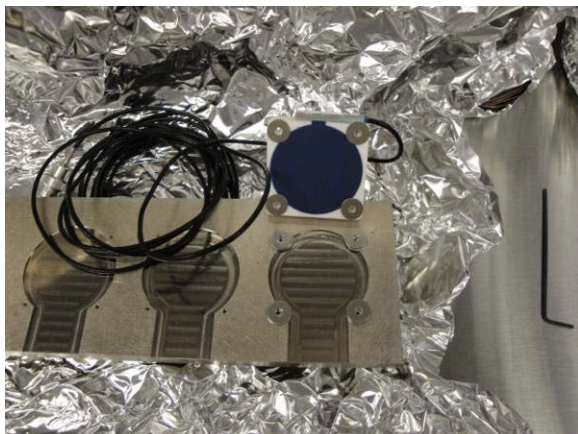

The displacement sensor mounted on the 6th spot of the test jig. Use teflon shims to check the gap:

1- Zeroing the offset of capacitive position sensors:

The range of the zeroing potentiometer is estimated to be + 5.5V and – 5.5V with a +-0.2V uncertainty from the differential outputs on the back of the satellite box. The counterclockwise rotation of the potentiometer was the direction most of the time it was turned when adjusted. So if the voltage read negative then the potentiometer was turned counterclockwise until the voltage was at about +-0.01V. **Fill the table below.**

S/N sensor	S/N board	ADE Gap Standoff(mm)	Location on the Jig	Gap Standoff on Jig(mm/in)	Voltage before zeroing	Voltage after zeroing. Prebake	Voltage after zeroing. Post bake

Table – Zeroing the offset of capacitive position sensors

The back panel reads 0.508V/0.001"

2- Measure power spectrum of the capacitive position sensor (V1/H1, V2/H2 and V3/H3) before baking.

Acceptance Criteria:

- Power spectrum magnitudes must be lower than:
 - o 9.e-10 m/√Hz at 0.1Hz
 - o 6.e-10 m/√Hz at 1Hz

The tests report must contain:

- 1- The table “Zeroing the offset of capacitive position sensors”
 - 2- Capacitive position sensors powerspectra
 - 3- Issues/difficulties/comments regarding this test
 - 4- Recall of the acceptance criteria
- Test results (Passed: ___ Failed: ___)

- ***Step 2: GS13***

All the data related to GS-13 post podding testing can be found in the **SVN at :**
SeismicSVN\seismic\Common\Data\aLIGO_GS13_TestData\PostMod_TestResults_PDFs.

E1000058 spreadsheet provides the status of each individual GS-13 at LLO site during aLIGO HAM assembly

Acceptance Criteria:

- GS13 should have been already tested. GS-13 Inspection/Pod Assembly (D047810). Checklist is defined in F090070-v6

The tests report must contain:

1- Test results (Passed: ___ Failed: ___)

- ***Step 3: Actuators***

Actuator data can be found at: T0900564. Actuator inventory is made at Section II – Step 1.

Acceptance Criteria:

- Actuators were previously tested and results are reported in T900564.

The tests report must contain:

1- Test results (Passed: ___ Failed: ___)

II. Tests to be performed during assembly

- *Step 1: Inventory (E1000052)*

DCC/Vendor number	Part name	Configuration	S/N	S/N	S/N
D071001	Stage 0 base				
D071051	Stage 1 base				
D071050	Optical table				
D071002	Spring Post				
D071100	Spring				
D071102	Flexure				
ADE	Position sensor	Horizontal			
		Vertical			
D047812	GS-13 pod	Horizontal			
		Vertical			
D047823	L4C pod	Horizontal			
		Vertical			
D0902749	Actuator	Horizontal			
		Vertical			

- *Step 2: Check torques on all bolts*

Procedure to follow for this test:

After any bolt or bolt pattern is torque, check the torque by reapplying the torque wrench to the bolt. For bolt patterns, torque the whole group to final spec, then start the pattern over again. The wrench should trip, and then the bolt should start moving.

Acceptance Criteria:

- All bolts should trip the wrench, and start moving immediately after. If any bolts in a pattern move before torque is reached, recheck after all bolts are brought to spec.

The tests report must contain:

1- Test result (Passed: ___ Failed: ___)

- *Step 3: Check gaps under Support Posts*

Procedure to follow for this test:

Try to push a 0.001 inch shim between the Support Post, Gussets and Stage 0 along the edges shown below.

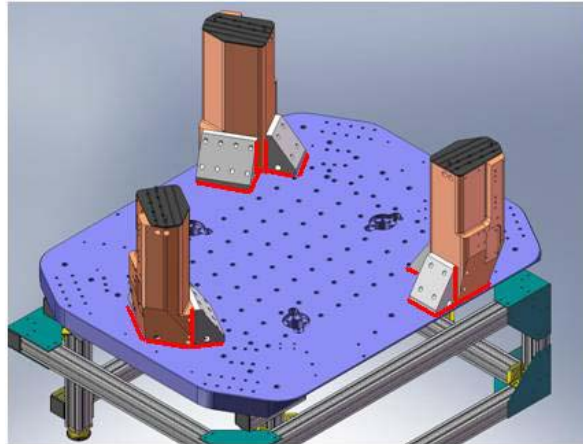

Figure - Showing edges that need checked on support posts and gussets

Acceptance Criteria:

- A 0.001 inch shim cannot be passed freely through any connection to Stage 0 or between post and gussets. If shim can pass through, loosen all constraining bolts, and then retighten iteratively from the center of the part to the edges. Retest.

The tests report must contain:

1- Test result (Passed: ___ Failed: ___)

▪ *Step 4: Pitchfork/Boxwork flatness before Optical Table install*

Procedure to follow for this test:

- Lay a straight-edge on edge across top edge of each subassembly where wall pieces intersect
- Try to insert shims between parts

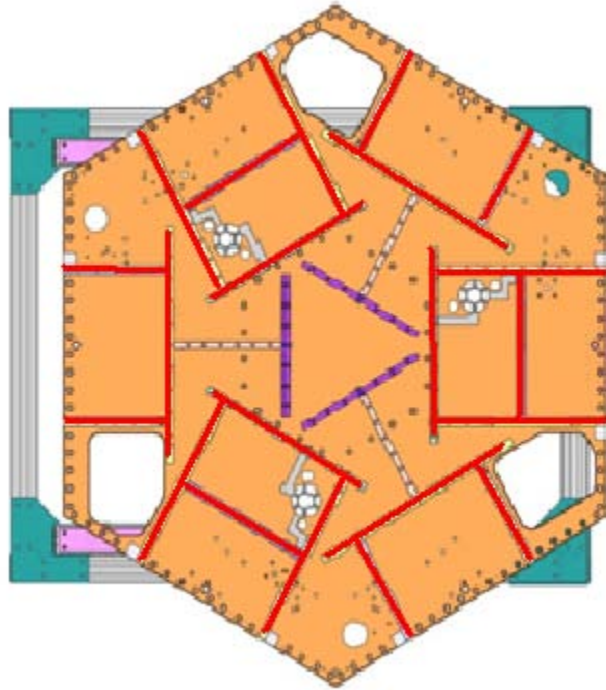

Figure - Showings that need check on Boxworks and Pitchforks

Acceptance Criteria:

- Shim inserted won't pass between parts.

The tests report must contain:

1- Test result (Passed: ___ Failed: ___)

▪ **Step 5: Blade spring profile**

Procedure to follow for this test:

1- Measure the blade profile with a plunge tip, or a depth gauge.

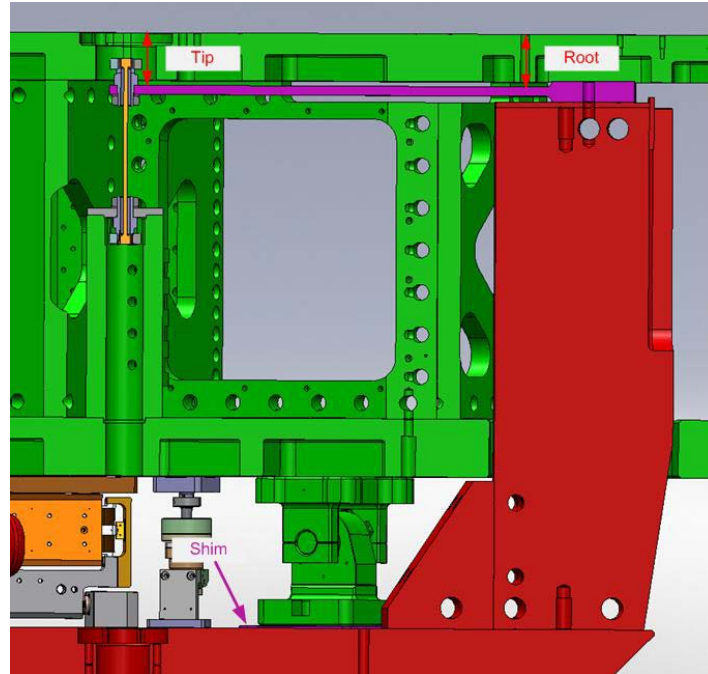

2- Fill the table below (nominal, if the distance is measured directly, is .149")

Blade #	Base (")	Tip(")	Flatness (mils)
1			
2			
3			

Table – Blades profile

Note: Measurement is height below Optical Table top surface to contact the Spring below. Weight of the plunge micrometer is observed to lower the Stage1 by up to 0.002” which should reduce the Root number making the Spring Tip higher.

Note that the tip measurement should be constant and that root value can be impacted by shims change.

Acceptance Criteria:

- Blades must be flat within 0.015" inches.

The tests report must contain:

- 1- The table “Blades’ profile”
- 2- Issues/difficulties/comments regarding this test
- 3- Test result (Passed: ___ Failed: ___)

▪ *Step 6: Gap checks on actuators-after installation on Stage 1*

Procedure to follow for this test:

After assembly use sized Teflon shims to measure gaps between stops and coils. Starting with 0.080", adjust the stack height until the Teflon shims just barely pass freely between the coils and stops. Record the results

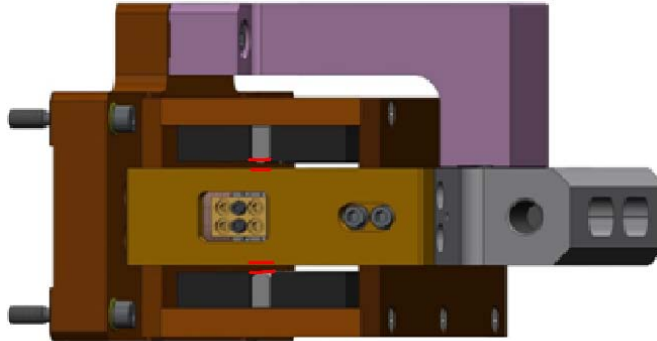

Figure - Showing gaps that need to be checked on actuators.

Issues/difficulties/comments regarding this test:



Figure - Stack of Teflon shims being measured for gap check of actuators.

Acceptance Criteria

- Gaps must be within 0.010" of design value (0.080")

The tests report must contain:

- 1- Test result (Passed: ___ Failed: ___)

▪ ***Step 7: Check level of Stage 0***

Optical Level measurement of Stage 0 at large (12 - 15) number of points.

Procedure to follow for this test:

- Set up the Optical Level so that it has a good view of Stage 0.
- Ensure that the instrument is set up level and stable.
- Looking through the optical level record the height on the target (LHO's shown below) of different points as evenly spaced as possible around Stage 0. It will be necessary to move the optical level to cover the whole assembly.
- After each move, check the heights of at least 2 previously measured points to control for the change in height at the new position. More overlap of measured points is better.

Note: The desired precision of these measurements is finer than that offered by most rulers, so it will be necessary to estimate from the optical level's reticule relative to a convenient mark on the ruler.

Acceptance Criteria

- The maximum angle of the table with the horizontal mustn't exceed $\sim 100\mu\text{rad}$

The tests report must contain:

- 1- **A schematic showing the measurements**
- 2- **Tilt computation**
- 3- **Issues/difficulties/comments regarding this test**
- 4- **Test result (Passed: ____ Failed: __)**

- **Step 8: Check level of Stage 1 Optical Table**

Optical Level measurement of Stage 1 at large (12 - 15) number of points.

Procedure to follow for this test:

- Same procedure as Stage 0

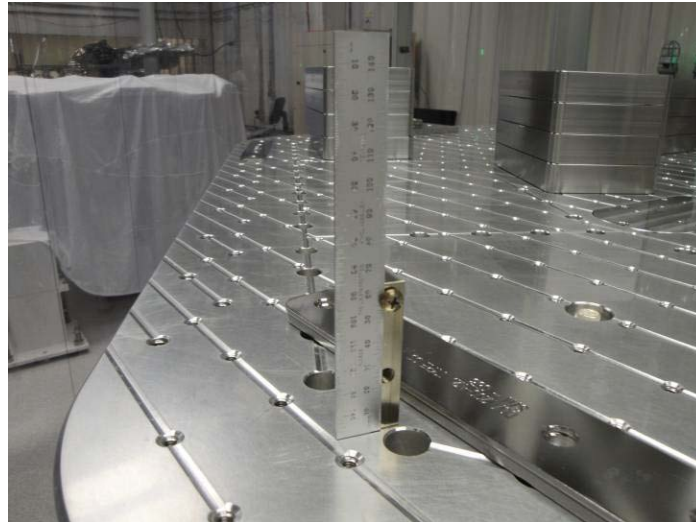

Figure – Checking level of stage 1 optical table

Acceptance Criteria

- The maximum angle of the table with the horizontal mustn't exceed $\sim 100\mu\text{rad}$

The tests report must contain:

- 5- A schematic showing the measurements
- 6- Tilt computation
- 7- Issues/difficulties/comments regarding this test
- 8- Test result (Passed: ___ Failed: ___)

▪ *Step 9: Mass budget*

Procedure to follow for this test:

- Record the amount of mass used for each location (Optical table, walls, keel) and report in a table like the following ones

		Mass								
Type		00	01	02	03	04	05	06		
Weight		0.6	1.1	2.2	4.5	7.9	15.6	27.2	lbs	kgs
Location	w1									
	w2									
	w3									
	w4									
	w5									
	w6									
	w7									
	w8									
	w9									
Location	k1									
	k2									
	k3									
	k4									
	k5									
	k6									

Table – Wall masses and Keel masses distribution

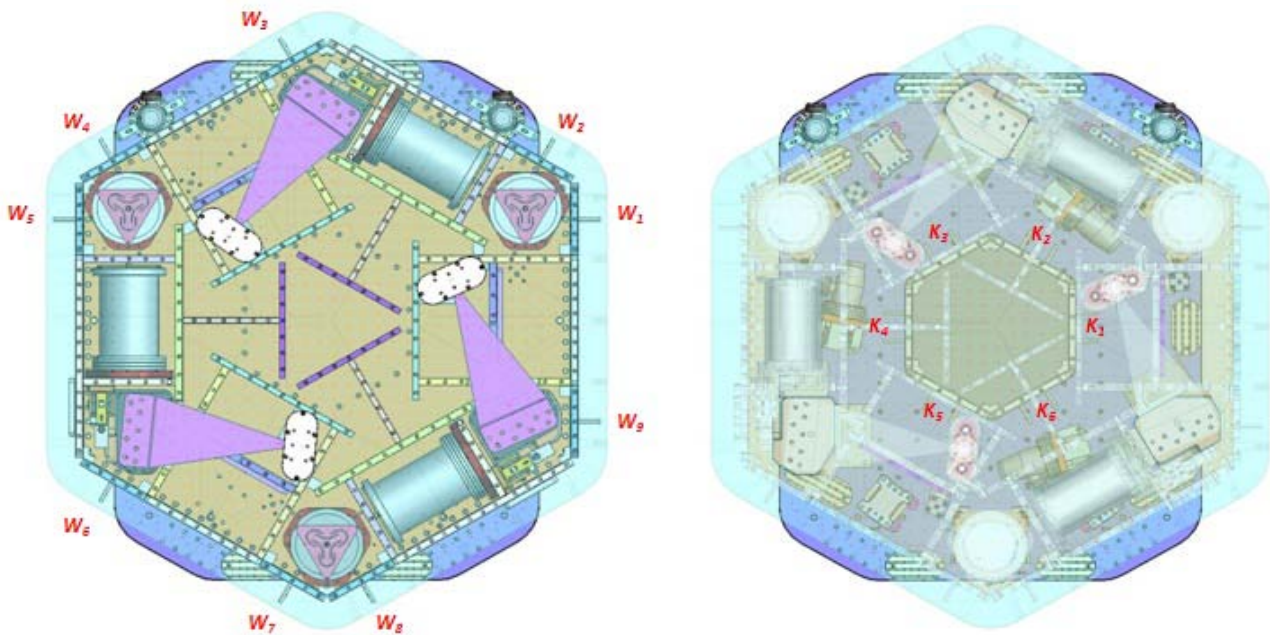

Figure – Keel Masses and Wall masses location

- Draw a map of masses distribution (a template can be found in on the SVN at /optseisvn/seismic/HAM-ISI/X1/Data/Unit_1/Report_Spreadsheets/Masses_on_optic_table.pptx)
- Take a picture of the optic table

Here is an example with the HAM-ISI-LLO – unit#1

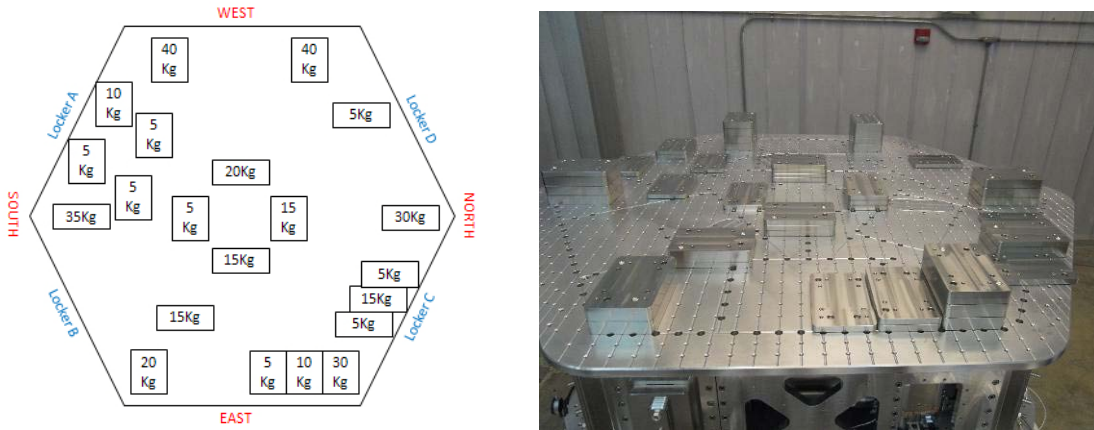

Figure - Masses distribution

	Side	Keel	Optical Table	Total
Weight (kg)				
Torque x at O (N.m)				
Torque y at O (N.m)				

Table - Masses distribution (can be computed using T1100261)

Acceptance Criteria

The Mass budget must be

- 579.1 Kg (cf E1100427)+/-25Kg (5%)

The tests report must contain:

- 1- The table “Masses distributions”
- 2- The table “Wall masses and Keel masses distributions”
- 3- Map or table of the mass location on the optic table
- 4- Picture of the optic table
- 5- Torque estimation
- 6- Issues/difficulties/comments regarding this test
- 7- Test result (Passed: ___ Failed: ___)

▪ **Step 10: Shim thickness**

- Report the shim thickness of each lockers

Lockers	Shim thickness (mil)
A	
B	
C	
D	

Table – Shims Thickness

The tests report must contain:

- 1- The table “Shim thickness”
- 2- Issues/difficulties/comments regarding this test
- 3- Test result (Passed: ___ Failed: ___)

▪ **Step 11: Lockers adjustment**

The figure below presents location (more details in **appendix 2**) of dial indicators (yellow) and lockers (blue dots and blue lines). Vertical Dial indicator read negative for increasing height of Optical Table. Horizontal dial indicators depend on location. Lockers A & C read negative for +RZ rotation of Stage 1 relative to Stage 0. B & D read positive for +RZ rotation. When locking and unlocking the table, try to lock and unlock always the same way. For instance, lock ABCD and unlock DCBA.

Before the test, make sure that all masses are bolted to the optic table.

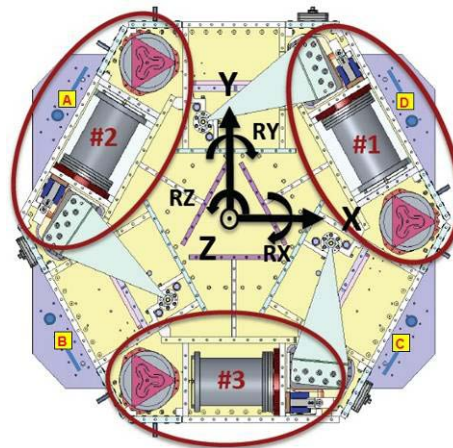

Figure - Top view of the HAM-ISI

Procedure to follow for this test:

Once the table is locked, dial indicators are set to zero and the table is released. In the table below reports the dial indicators evolution when unlocking the table. We consider the table centered when the difference doesn't exceed 0.002".

D.I at Lockers	Dial indicators V	Dial indicators H
A		
B		
C		
D		

Table – Dial indicators read-out (table locked-unlocked)

Acceptance Criteria

- Vertical and horizontal displacement near the lockers must be lower than 2 mils (0.002")

The tests report must contain:

- 1- The table “Dial indicators read-out (table locked-unlocked)”
- 2- Issues/difficulties/comments regarding this test
- 3- Test result (Passed: ___ Failed: ___)

III. Tests to be performed after assembly

This section describes the tests performed to check and validate the subassemblies and overall assembly good functioning. From step 8, data collected, Matlab scripts and figures, documentation have to be posted on the local copy of the SVN. Appendix 4 describes the path used to store data. X1 and X1 are respectively the Hanford and the Livingston test stand. In this procedure document, an example is given for the test realized on HAM-ISI-LHO-Unit1. SVN information that refers to sites, units and dates are colored **in red** (Scripts, data and figures names). Black is used for generic name.

It is good practice to run a "svn update" in all folders before starting work and finish the day with a "svn commit"!

- ***MEDM set-up for testing***

MEDM

- In MEDM open G1ISIHAM_HAM_OVERVIEW.adl at the following location :
/rtcds/geo/g1/medm/g1isiham/G1ISIHAM_HAM_OVERVIEW.adl
- Edit the watchdog values with the parameters in the table below or upload with
HAM_ISI_X1_Populate_All_Matrices.m

Upload Watchdog limit values

Watchdog values, base change matrices can be uploaded with:

HAM_ISI_X1_Populate_All_Matrices.m in the SVN at ~/seisvn/seismic/HAM-ISI/X1/Scripts/

For testing, **GS13 watchdog are set to 40000.**

Watchdog	Limit (counts)	Safe Limit (counts)
STS	20000	30000
GS13	40000	30000
CPS	20000	30000
Actuators	20000	30000

Table - Watchdogs set-up

Unless otherwise specified, all tests should be done without the dial indicators on.

▪ **Step 1 - Electronics Inventory**

Write down serial number of coil driver, Anti aliasing chassis, Anti image chassis and interface chassis used for this test are listed below:

Hardware	LIGO reference	S/N
Coil driver	D0902744	
Anti Image filter	D070081	
Anti aliasing filter	D1000269	
Interface chassis	D1000067	

Table - Inventory electronics

Acceptance Criteria

- Inventory is complete

The tests report must contain:

- 1- The table “Inventory electronics”
- 2- Issues/difficulties/comments regarding this test
- 3- Test result (Passed: ___ Failed: ___)

▪ **Step 2 - Set up sensors gap**

During this step, sensors gap are adjusted.

Procedure to follow for this test:

- Lock the table
- Add 10 Kg masses at each corner (A, B, C ,D ,E, F)

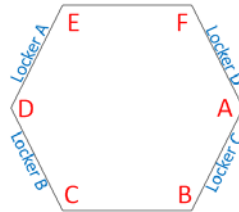

Figure – Corners location

- Pull up the capacitive position sensors (CPS) signals in a data viewer window
- Adjust the displacement sensor target position so that the collocated DISP channels readout fewer than 400 counts on Dataviewer (a bit less than .0005”).
- Lock the target
- Write down the mean values and standard deviation in the table below

Matlab script:

A matlab function called “Offset_STD_CPS_HAM_ISI.m” can be executed to get offsets and standard deviations of the CPS sensors. This function is located in the SVN at: [seisvn/seismic/HAM-ISI/X1/Scripts/Data_Collection/](#).

It computes the offset/STD at the execution time. The function waits for about 40 s before getting the results (30s are required before accessing the data from the frame builder). Column 1 of the table “Offset_STD_CPS” reports the offsets, column 2 reports the Standard deviations. Lines are the sensors (H1, H2, H3, V1, V2 and V3). The result table “Offset_STD_CPS” can be copied and pasted in the test report as it is. This function doesn’t save any .mat file.

Note that if results return artificial '0' counts on the last channels, you need to increase the allowed time in the “Offset_STD_CPS_HAM_ISI.m” script.

Notes:

- Before starting the gap set up, the targets are typically far from their target and consequently out of range. The signal should be +32000 counts. However, when the ADC saturates it can go to 0. The bottom line is that a 0 count signal doesn’t mean that the sensor is broken.
- When the target to sensor gaps gets larger, the MEDM count value increases (maximum gap is positive). When the target to sensor gaps gets smaller, the MEDM count value decreases (minimum gap is negative).

Table locked	ADE boxes on		ADE boxes on/off	
Sensors	Offset (Mean)	Std deviation	Offset (Mean)	Std deviation
H1				
H2				
H3				
V1				
V2				
V3				

Table – Capacitive position sensor readout after gap set-up

Acceptance criteria:

- All mean values must be lower than 400 cts (a bit less than .0005”).
- All standard deviations below 5 counts.
- No cross talk

The tests report must contain:

- 4- The table “Capacitive position sensors readout after gap set-up”
- 5- Issues/difficulties/comments regarding this test
- 6- Test result (Passed: ___ Failed: ___)

▪ **Step 3 - Measure the Sensor gap**

The test verifies that sensors gap measured on the Jig doesn't change after the assembly.

Procedure to follow for this test:

- Measure the gaps between probes and targets using Teflon shims on the Jig and once sensors have been installed on the table. Try to measure the gap at the edge of the sensor to avoid scratches on the target.
- Fill the table below.

Sensors	Gap measured on the Jig	Gap measured on the table	% of change	Offset sensors (counts)
H1				
H2				
H3				
V1				
V2				
V3				

Table - Measured sensors gap

Acceptance criteria:

Sensors gap measured on the jig and on the optic table must be:

- 0.080" +/-0.002"

The tests report must contain:

- 1- The table "Measured sensors gap"
- 2- Issues/difficulties/comments regarding this test
- 3- Test result (Passed: ___ Failed: ___)

▪ **Step 4 - Check Sensor gaps after the platform release**

During this test, the motion of the table between the locked and the unlocked position without dial indicators is evaluated.

Procedure to follow for this test:

- Remove dial indicators
- Pull up the CPS signals in a data viewer window or Matlab
- Lock the table
- Write down CPS mean values in the table below or use the Offset_STD_CPS_HAM_ISI.m matlab script
- Unlocked the table
- Write down CPS mean values in the table below or use the Offset_STD_CPS_HAM_ISI.m matlab scripts

Sensors	Table locked		Table unlocked	
	Offset (Mean)	Std deviation	Offset (Mean)	Diff unlocked - locked
H1				
H2				
H3				
V1				
V2				
V3				

Table – Sensors readout before and after optic table release

Acceptance criteria:

- Absolute values of the difference between the unlocked and the locked table must be below:
 - o 1600 cts for horizontal sensors (~0.002’')
 - o 1600 cts for vertical sensors (~0.002’')
- Considering the acceptance criteria of step 4, all mean values must be lower than
 - o 2000 cts for horizontal sensors (~0.0025’')
 - o 2000 cts for vertical sensors (~0.0025’')

The tests report must contain:

- 1- The table “Sensors readout before and after optic table release”
- 2- Issues/difficulties/comments regarding this test
- 3- Test result (Passed: ___ Failed: ___)

▪ **Step 5 – Performance of the limiter**

The two following tests enable to verify three points:

- Sensors signs
- Sensors range of measurement
- To double check the optical table range of motion

▪ **Step 5.1 - Test N°1 - Push “in the general coordinates”**

This test requires two persons in the clean room and one person in front of the computer.

Procedure to follow for this test:

- Unlock the optic table
- The two operator in the clean room push simultaneously on the optic table in the direction +Z or -Z or +RZ or -RZ until the table touches the lockers
- The operator in front of dataviewer write down the sensors readout when the table touches the lockers or runs the Offset_STD_CPS_HAM_ISI.m matlab script
- Report the sensor readout in the table “Optic table range of motion”

Vertical displacement sensors:

At each corner, push down gently (uniformly) on the optic table and watch the response in dataviewer. While pushing up/down, you have to make sure that the table is not rotating. All sensors should respond with the same sign. **When the table is going down (-Z), the gap between the probe and the sensor decreases. Consequently vertical sensor readout is going in the negative direction.** Push up/down until the optic table is in contact with the locker. Report the MEDM count values in the table below.

Horizontal displacement sensors:

At each corner, push the structure tangentially at the plane of the sensors in one direction. While rotating, you have to make sure that the table is not going up/down. All sensors should respond with the same sign. **When the table is turning -RZ or clockwise (viewed from top), the gap between the probe and the sensor decreases. Consequently, horizontal sensor readout is going in the positive direction.** Rotate until the optic table touches the locker. Report the MEDM count values in the table below.

Sensors	CPS read out		Calculated after calibration	
	UP (Counts)	Down (Counts)	UP (mil)	Down (mil)
V1				
V2				
V3				

Sensors	CPS read out		Calculated after calibration	
	CW(-RZ)	CCW (+RZ)	CW (mil)	CCW (mil)
H1				
H2				
H3				

Table - Optic table range of motion

▪ **Step 5.2 - Test N°2 – Push “locally”**

The main thing here is we want to make sure our Actuators & Sensors have zero chance of ever contacting (the lockers should always limit the Actuators/Sensors from closing their gaps).

Procedure to follow for this test:

- Apply manually a force collinear to the sensor axis you are testing (+ and - directions)
- For displacement sensors check
 - o Move the table such that the target is as close as you can get it to the Sensor Head. This motion is monitored visually in dataviewer and Sensor counts are recorded.
 - o Move the table such that the target is as far as you can get it to the Sensor Head. This motion is monitored visually in dataviewer and Sensor counts are recorded.
- For the Actuators, check all possible contacts point was a little tough. One person watches the Actuator while two people move the table in every direction possible. If there is no contact give the Actuator a positive “X”/PASS.

Displacement sensors and actuator gap check:

	Push in positive direction sensor readout (count)	Push in negative direction Sensor readout (count)	Railing	Actuator Gap Check
H1				
H2				
H3				
V1				
V2				
V3				

Table - Sensors and Actuators gap check

Acceptance criteria:

- The vertical sensor readout be positive when the optic table is pushed in the +Z direction
- The horizontal sensor readout be negative when the optic table is pushed in the +RZ direction
- **Step 7.1**
 - o Absolutes value of all estimated motions must be higher than 16000counts (~0.020”)
- **Step 7.2**
 - o No contact point on sensors
 - o Absolute value of sensor read out must be higher than 16000counts (~0.020”)
 - o No contact point on actuators

The tests report must contain:

- 1- The table “Optic table range of motion”
- 2- The table “Sensors and actuators gap check”
- 3- Issues/difficulties/comments regarding this test
- 4- Test result (Passed: ___ Failed: ___)

▪ *Step 6 - Position Sensors unlocked/locked Power Spectrum*

The following test verifies the functioning of Capacitive Position Sensors as well as the existence of crosstalk between sensors satellite boxes. The Pre-filter inputs channels (for example **G1:ISI-HAM_DISPPF_H1_IN1_DAQ - G1:ISI-HAM_GEOPF_H1_IN1_DAQ**) are recorded for these measurements. This test is performed with the table locked and unlocked.

At the same time, functioning of GS13 geophones is verified once they have been installed in the HAM-ISI. To perform this test, powerspectra are measured in different configurations (table locked and unlocked)

1- Power spectra measurements are performed via Matlab with the following parameters:

- BW = 0.02Hz
- Averages = 50
- Overlap = 50%

2- The testing configurations are the followings:

- Satellite boxes 1 and 2 powered ON and synchronized
 - Table locked with an additional mass of 6x10 Kg on the top of the optic table
 - Table unlocked

Matlab script

A Matlab function is used to plot and calibrate the power spectra of the CPS and the geophones when the table is unlocked and locked. Powerspectra of the GS13 are reported in Step 9.1.

Follow the steps below:

- 1- Write down the GPS Time when the table is unlocked and wait for 45 minutes
- 2- Lock the table, write down the GPS Time and wait for 45 minutes
- 3- Open the script Powerspectra_Measurements_Locked_Unlocked_HAM_ISI.m located in the SVN at seisvn/seismic/HAM-ISI/X1/Scripts/Data_Collection/.
- 4- Edit GPS_TIME (unlocked, locked configuration), edit the location where the figures and the data will be saved (Save_Figure_Path and Save_Data_Path), Edit autosave_plot to 1.
- 5- Run the script and paste the figure in report

Issues/difficulties/comments regarding this test: Capacitive sensors use electric field for sensing. When multiple, independent capacitive sensors are used simultaneously, the electric field from one probe may be trying to add charge to the target, while another sensor is trying to remove charge. This conflicting interaction with the target will create errors in the sensors' outputs. This problem is easily solved by synchronizing the sensors. Synchronization sets the drive signal of all sensors to the same phase so that all probes are adding or removing charge simultaneously and the interference is eliminated. Interferences between ADE boxes can be roughly estimated by measuring standard deviation when one out of two satellite boxes is off.

Example of SVN path with HAM-ISI-LLO-Unit-1

Matlab

Data files in SVN at:

seisvn/seismic/HAM-ISI/X1/Data/Unit_1/Powerspectra/Undamped

- LHO_HAM_ISI_Unit_1_Calibrated_PSD_CPS_GS13_Unlocked_Locked_YYYY_MM_DD.mat

Figures in SVN at:

seisvn/seismic/HAM-ISI/X1/Data/Unit_1/Figures/Powerspectra/Undamped

LHO_HAM_ISI_Unit_1_Calibrated_PSD_CPS_GS13_Unlocked_Locked_YYYY_MM_DD.fig

Acceptance criteria:

- No cross talk (peaks at low frequencies + harmonics on measurements)
- Magnitudes of power spectra must be between requirement curves such as in the following figures (dashed lines)

Sensors	ISI state	Frequency (Hz)	2×10^{-2}	1×10^{-1}	1	10	20	100	1000
GS-13	Table locked	Max	3×10^{-1}	3×10^{-4}	3×10^{-7}	10^{-7}		10^{-11}	10^{-14}
		Min	3×10^{-4}	3×10^{-7}	3×10^{-10}	10^{-12}		10^{-14}	10^{-17}
	Table unlocked	Max	1	3×10^{-3}	10^{-5}	10^{-9}		10^{-11}	10^{-14}
		Min	10^{-4}	3×10^{-7}	10^{-9}	10^{-13}		10^{-15}	10^{-18}
CPS	Table locked	Max	2×10^{-7}	2×10^{-8}	10^{-8}	5×10^{-8}	2×10^{-7}	5×10^{-9}	10^{-9}
		Min	5×10^{-9}	2×10^{-9}	8×10^{-10}	5×10^{-10}		10^{-10}	5×10^{-11}
	Table unlocked	Max	2×10^{-6}	8×10^{-7}	8×10^{-7}	5×10^{-8}	2×10^{-7}	2×10^{-8}	10^{-9}
		Min	10^{-7}	5×10^{-8}	8×10^{-9}	5×10^{-10}		2×10^{-10}	10^{-10}

Table - Step 6 -Normal conditions-Sensors powerspectra requirements

The tests report must contain:

- 1- The calibrated powerspectra of capacitive position sensors
- 2- SVN paths of
 - a. Data files (with date label)
 - b. Figures
- 3- Issues/difficulties/comments regarding this test
- 4- Test result (Passed: ___ Failed: ___)

▪ **Step 7 - GS13 power spectrum -tabled tilted**

Functioning of the GS-13s in the full range of motion of the ISI is tested hereafter. Each corner of the table are successively grounded, and we measure power spectra in these various tilts positions. The Pre-filter output channels (for example **G1:ISI-HAM_GEOPF_H1_IN1_DAQ**) are recorded for these measurements.

1- This measurement is performed via Matlab with the following parameters:

- BW = 0.5Hz
- Averages = 50
- Overlap = 50%

2- The testing configurations are the followings:

- Table unlocked with a mass of 10 Kg at one corner of the optic table (1 mass at the time).

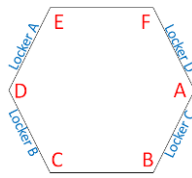

Figure – Corners location

Matlab

A Matlab function is used to plot the power spectra of the Geophones when the table is tilted.

Follow the steps below:

- 1- Write down the GPS Time after placing the Mass at one corner.
- 2- Wait for 120s.
- 3- Proceed for every corner.
- 4- Open the script Powerspectra_Measurements_Tilted_HAM_ISI.m located in the SVN at `seisvn/seismic/HAM-ISI/X1/Scripts/Data_Collection/`.
- 5- Edit the GPS time for the different masses location and run the scripts. Edit the location where the figures and the data will be saved (Save_Figure_Path and Save_Data_Path), Edit autosave plot to 1)
- 6- Run the script and paste the figure in the report

Matlab

Data files in SVN at:

`seisvn/seismic/HAM-ISI/X1/Data/Unit_1/ Powerspectra/Undamped`

- `LHO_HAM_ISI_Unit_1_Calibrated_PSD_CPS_GS13_Tilted_YYYY_MM_DD.mat`

Figures in SVN at:

`seisvn/seismic/HAM-ISI/X1/Data/Unit_1/Figures/Powerspectra/Undamped`

- `LHO_HAM_ISI_Unit_1_Calibrated_PSD_CPS_GS13_Tilted_YYYY_MM_DD.fig`

Acceptance criteria:

- With table unlocked and tilted, magnitudes of power spectra must be lower than:

Sensor	ISI State	Frequency	5×10^{-1} Hz	1	10	100	1000
GS-13	Table	Max	2×10^{-5}	2×10^{-6}	8×10^{-8}	4×10^{-11}	3×10^{-14}
	Tilted	Min	10^{-8}	10^{-9}	2×10^{-11}	10^{-14}	10^{-17}

Table - Table Tilted- Sensors powerspectra requirements

The tests report must contain:

- 1- The calibrated powerspectra of geophones
 - a. When the table is locked
 - b. When the table is unlocked
 - c. When the table is unlocked with a mass at one corner (A, B, C, D, E, F)
- 2- SVN paths of
 - a. Data files (with date label)
 - b. Script file use for calibration (with date-label)
 - c. Figures
- 3- Issues/difficulties/comments regarding this test
- 4- Test result (Passed: ___ Failed: ___)

▪ **Step 8- GS13 pressure readout**

During this test, the pressure sensors of the 6 GS13s is checked using a Matlab function gs13Presstest. These plots should be as long as possible (i.e. as long as the ISI is connected to the test stand)

The function is called as follows

```
gs13Presstest(GPS starting time, Measure duration given in seconds,  
{'G1:ISI-HAM_PRESSMON_GEO_H1_IN1_DAQ.mean';  
'G1:ISI-HAM_PRESSMON_GEO_H2_IN1_DAQ.mean';  
'G1:ISI-HAM_PRESSMON_GEO_H3_IN1_DAQ.mean';  
'G1:ISI-HAM_PRESSMON_GEO_V1_IN1_DAQ.mean';  
'G1:ISI-HAM_PRESSMON_GEO_V2_IN1_DAQ.mean';  
'G1:ISI-HAM_PRESSMON_GEO_V3_IN1_DAQ.mean'}, Boolean indicating whether the plot should  
be saved or not)
```

Acceptance criteria:

- The pressure on all channels must be 25000 counts +/- 3000 counts
- All channels must follow comparable trend

The tests report must contain:

- 1- The plot
- 2- Test result (Passed: ____ Failed: ____)

▪ **Step 9 - Coil Driver, cabling and resistance check**

Before driving actuators, a few tests have to be carried out to check for shorts.

On the actuator cable (vacuum side of the feedthrough)

The actuator cable is a three pin cables. All three pins are connected to a voltage drive, even though only two pins are used to drive actuators.

Pins are connected such as:

- Pin #1 (left pin in view below) is neutral return
- Pin #2 (middle pin) is the drive pin
- Pin #3 (right pin) is shield ground.

Make sure the shield ground is not connected to the middle pin of the plug. If not, swap middle pin with pin #3.



Figure – Actuator cable plugged on the feedthrough

Procedure to follow for this test:

- Turn coil Driver (D0902744) OFF
- Disconnect the actuator cable at the back side of the coil driver
- Measure the resistance between the side pins and the middle pin of the actuator cable
- Turn D0902744 ON and make sure all LEDs on the front panel are green
- Measure the coil driver output for a 1000 counts offset drive (if no voltage, check the anti-image pin)
- Reconnect actuator cable to the coil driver

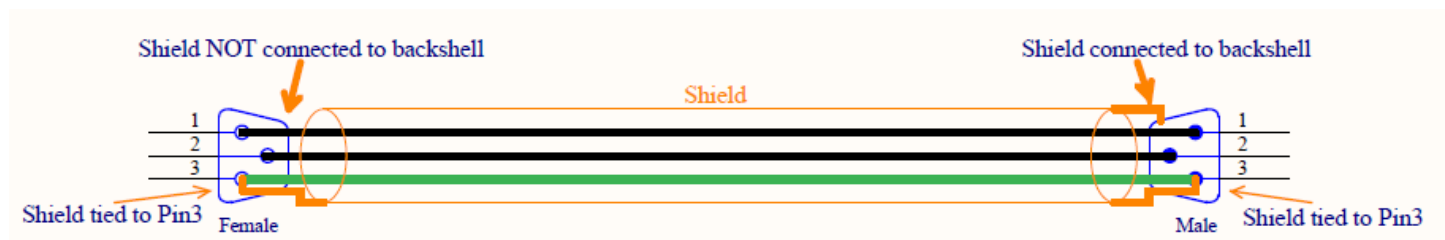

Figure – Actuator cable between feedthrough and test rack

Actuator	V1		H1		V2	
Coil driver						
Anti image pin #	1		2		3	
Cable #						
Resistance (Ohm)	P1 - P2	P2 - P3	P1 - P2	P2 - P3	P1 - P2	P2 - P3
MEDM offset (1000 counts)	Measurement P2 (-) ; P1&P3 (+)		Measurement P2 (-) ; P1&P3 (+)		Measurement P2 (-) ; P1&P3 (+)	

Actuator	H2		V3		H3	
Coil driver						
Anti image pin #	4		5		6	
Cable #						
Resistance (Ohm)	P1 - P2	P2 - P3	P1 - P2	P2 - P3	P1 - P2	P2 - P3
MEDM offset (1000 counts)	Measurement P2 (-) ; P1&P3 (+)		Measurement P2 (-) ; P1&P3 (+)		Measurement P2 (-) ; P1&P3 (+)	

Table - Actuators resistance check

Acceptance criteria:

- The measured resistance between the middle pin and one side pin must be 6.5 +/-1 ohms
- Actuator neutral pins must be connected on pin #1 (left side pin of the plug)
- Actuator drive pins must be connected on pin #2 (middle pin of the plug)
- Actuator ground shield pins must be connected on pin #3 (right pin of the plug)
- All LEDs on the coil driver front panel must be green

The tests report must contain:

- 1- The table “Actuators resistance check”
- 2- Issues/difficulties/comments regarding this test
- 3- Test result (Passed: ____ Failed: ____)

▪ **Step 10 - Actuators Sign and range of motion (Local drive)**

In this step, actuators signs are verified and the range of motion is measured when the table is moved by actuators.

In this step, the range of motion of the optic table is checked when applying a local drive on actuators.

Matlab

A Matlab function is used to execute the “Range of motion – Local drive test”

Follow the steps below:

- 1- Open the Matlab script `Range_Motion_HAM_ISI.m` located in the SVN at `seisvn/seismic/HAM-ISI/X1/Scripts/Data_Collection/`
- 2- Edit the data name (`LHO_HAM_ISI_Unit_1_Range_Of_Motion_Date`), edit the path (`seisvn/seismic/HAM-ISI/X1/Data/Unit_1/Static_Tests`)
- 3- Copy and paste the table in the test report as it is

`Range_Motion_HAM_ISI.m` drives a +/-30000 counts offset in a single actuator and get the Local CPS readouts.

	Negative drive	Positive drive
H1 readout (count)		
H2 readout (count)		
H3 readout (count)		
V1 readout (count)		
V2 readout (count)		
V3 readout (count)		

Table - Range of motion - Local drive

Acceptance criteria:

- Main couplings sensors readout must be at least 16000 counts (~0.02”)
- A positive offset drive on one actuator must give positive sensor readout on the collocated sensor. Signs will also be tested when measuring local to local transfer functions.

Note that if a positive offset drive does not give a positive sensor offset, this can be corrected as follows

- turn **D0902744 OFF**, swap pin #1 (not the shield ground) with the middle pin (pin #2) on the accuglass cable
- Turn **D0902744 ON**
- Retest

The tests report must contain:

- 1- The table “Range of motion-Local drive”
- 2- Issues/difficulties/comments regarding this test
- 3- Test result (Passed: ___ Failed: ___)

▪ **Step 11 - Vertical Sensor Calibration**

During this test, the vertical sensitivity of the position sensors is measured.

Procedure to follow for this test:

- **Install exclusively vertical dial indicators** as described in appendix and set to zero when the table is unlocked
- Set actuators watchdog to 25000counts
- In the Isolation filters bank
 - o Set the gain to 0 on Z direction
 - o Set the ramp time to 20s
 - o Set a 10000 counts offset on Z direction
 - o Change the gain to 6
- When driving, make sure there is no contact between the table and the lockers. If the table is touching, reduce offset.
- Write down dial indicators and position sensors mean values
- Drive a negative offset on all vertical actuators (make sure there is no contact between the table and the lockers)
- Write down dial indicators and position sensors mean value
- Compute sensitivity using ADC calibration:
 $2^{15} \text{ Count}/20\text{V} = 32768 \text{ Count}/20 \text{ V} = 1638 \text{ Count/Volt}$
- Reset the actuators watchdog at 20000counts

D.I at Lockers	D.I readout with for a negative drive	D.I readout without any drive	D.I readout with for a positive drive
A			
B			
C			
D			
Average			

Sensors	Read out (Counts)	Readout (Counts)	Readout (Counts)	Difference (Counts)
V1				
V2				
V3				
			Average	

Table - Calibration of capacitive position sensors

Vertical sensitivity: / = count/mil

or count/mil * 1/ 1638V/count = V/mil

or 25400nm/mil * 1/ mil/count = nm/count

Nominal Calibration

CPS Sensitivity: $20\text{V}/0.039'' = 20\text{V}/39\text{mils} = 0.513\text{V}/\text{mil}$

Calibration in counts: $2^{15} / 20 * 20/39 = 840 \text{ count}/\text{mil}$

or $25400 \text{ nm}/\text{mil} * 1/840 \text{ mil}/\text{count} = 30.2\text{nm}/\text{count}$

$$\text{Change} = (\text{Calibration measured}-840)/840=\%$$

Acceptance criteria:

- Deviation from nominal value < 2%. Nominal value is 840 count/mil.

The tests report must contain:

- 1- The table "Calibration of capacitive position sensors"
- 2- Fill vertical sensibility values
- 3- Issues/difficulties/comments regarding this test
- 4- Test result (Passed: ____ Failed: ____)

▪ **Step 12 - Vertical Spring Constant**

This test verifies the vertical spring constant. The procedure is detailed below:

- Remove dial indicators
- Write down initial position of the unlocked table given by position sensors
- Place calibrated weights (3 x 2Kg) at various positions on Stage. The masses must be placed at equal radii from the center of Stage 1, at symmetric angles around the table. If possible, use the hatches as reference points. (A,B,C)
- Measure displacements with position sensors after loading a total of 6 Kg. Make sure the optic table is not touching the lockers
- Repeat the measurement after swapping masses (A,B,C=>B,C,A=>C,A,B)
- After averaging, fill the table below

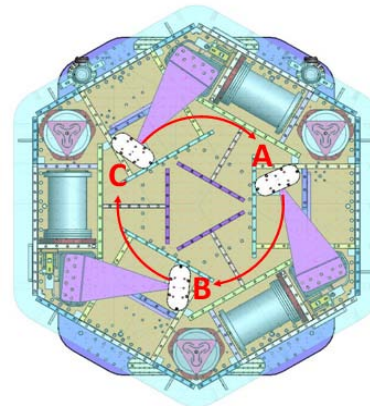
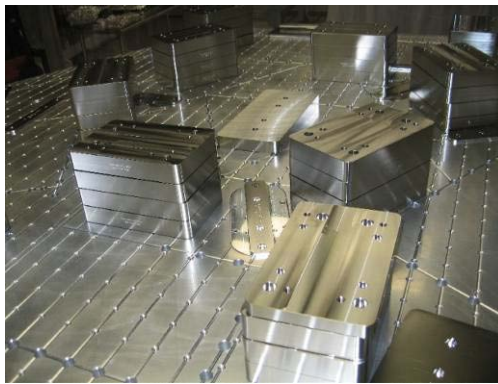

Figure – Vertical spring constant measurement – Hatches as reference points

Results presented below are obtained after the initial sensors calibration.

Sensors	Mean diff counts	Mean diff m	K (N/m)	Error with average
V1				
V2				
V3				
Average (N/m)				
Total Stiffness (N/m)				

Table - Vertical spring constant

Acceptance criteria:

- +/-2 % of 2.4704e5 N/m (i.e. between 2.421e5 and 2.520e5 N/m)
- +/- 5% of variation between each spring and the average

The tests report must contain:

- 1- The table “Vertical spring constant”
- 2- Issues/difficulties/comments regarding this test
- 3- Test result (Passed: ___ Failed: ___)

▪ **Step 13 - Static Testing (Tests in the local basis)**

This test verifies three points:

- Actuators-sensors readout chains
- Static main coupling and cross coupling
- Actuator power (driving signal and actuator response)

Matlab

A Matlab function is used to execute the “Static Testing (Tests in the local basis)”

Follow the steps below:

- 1- Open the Matlab script `Sensor_Readout_Local_Drive_MEDM_HAM_ISI.m` located in the SVN at `seisvn/seismic/HAM-ISI/X1/Scripts/Data_Collection/`
- 2- Edit the data name (`LHO_HAM_ISI_Unit_1_Offset_Local_Drive_Date`), edit the path (`seisvn/seismic/HAM-ISI/X1/Data/Unit_1/Static_Tests`)
- 3- Copy and paste the table in the test report as it is

`Sensor_Readout_Local_Drive_MEDM_HAM_ISI.m` drives a 1000 counts positive offset on the local actuators and reads all the CPS sensors.

Vertical actuators

A positive offset drive on one vertical actuator creates a positive offset readout on the collocated sensor and a negative offsets readout on other vertical sensors. For a 1000 counts positive offset drive on vertical actuators, the collocated sensor readout should be about 1400 counts.

Horizontal actuators

A positive offset on one horizontal actuator drive creates a positive offset readout on every horizontal sensor. For a 1000 counts positive offset on horizontal actuators, the collocated sensor readout should be about 2000 counts and about 1250 counts on the other horizontal sensors.

		Sensors (counts)					
		H1	H2	H3	V1	V2	V3
Actuators (1000 counts)	H1						
	H2						
	H3						
	V1						
	V2						
	V3						

Main coupling
 Important cross coupling

Table - Main and cross coupling - Static

Acceptance criteria:**- Vertical**

For a +1000 count offset drive on vertical actuators

- Collocated sensors must be 1400 counts +/- 10%

- Horizontal

For a +1000 count offset drive on horizontal actuators

- Collocated sensors must be 2000 counts +/- 10%
- Non-collocated horizontal sensors must be 1250 counts +/-10%

The tests report must contain:

- 1- The table “Main and cross coupling -Static”**
- 2- Issues/difficulties/comments regarding this test**
- 3- Test result (Passed: ____ Failed: ____)**

▪ **Step 14 - Linearity test**

The linearity of the triplet Actuators-HAM-sensors is evaluated during the following test.

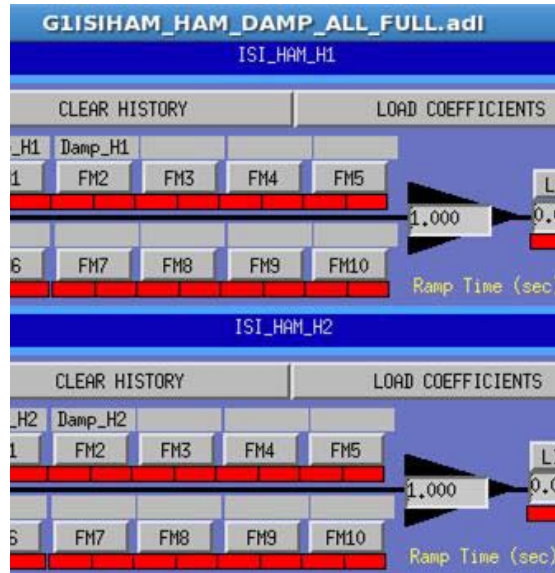

Figure – State of the damp MEDM screen- All gains must be set to 1!

Matlab

A Matlab function is used to execute the “Linearity Test”

Follow the steps below:

- 1- Open the Matlab script Linearity_Test_Awgstream_HAM_ISI.m located in the SVN at seisvn/seismic/HAM-ISI/X1/Scripts/Data_Collection/
- 2- Edit the data name (LHO_HAM_ISI_Unit_1_Linearity_Test_Date), edit the data path (seisvn/seismic/HAM-ISI/X1/Data/Unit_1/Linearity_Test) and the figure path
- 3- Copy and paste the table Slopes_Offset in the test report as it is
- 4- Paste the figure in the report

Linearity_Test_Awgstream_HAM_ISI.m performs the linearity Test. It plots the linearity test and computes the slopes)

Plot_linearity_Test.m (This script enables to replot the linearity test)

Report slopes in this table

	Slope	Offset	Average slope	Variation from average(%)
H1				
H2				
H3				
V1				
V2				
V3				

Table - Slopes and offset of the triplet Actuators - HAM-ISI - Sensors

Acceptance criteria:

- Horizontal and vertical slopes of the triplet actuators x HAM-ISI x sensors: Average slope +/- 1%

The tests report must contain:

- 1- The table “Linearity of the triplet Actuators – HAM – ISI - Sensors”
- 2- The table “Slopes and offset of the triplet Actuators – HAM – ISI - Sensors”
- 3- Figures that shows linearity on vertical and horizontal axis
- 4- Issues/difficulties/comments regarding this test
- 5- Test result (Passed: ____ Failed: ____)

▪ **Step 15 - Cartesian Basis Static Testing**

During this step, change of basis matrices uploaded prior to start testing are checked. These matrices are given in Appendix D and can be loaded with HAM_ISI_X1_Populate_All_Matrices.m in the SVN at :

~/seisvn/seismic/HAM-ISI/Common/Basis_Change_Matrices/

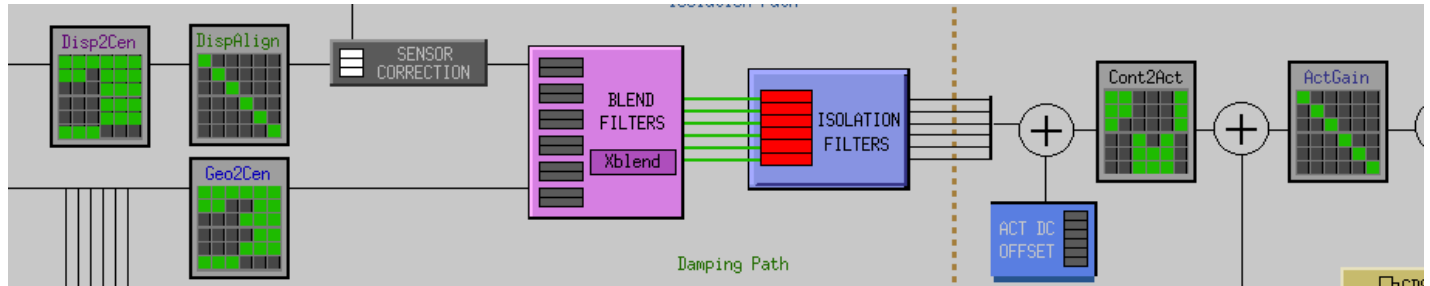

Figure – Matrices are filled

The electronic compensation filters and matrices defined in Appendix D should be on at this point!



Figure – State of the Geophone readout MEDM screen: compensation filters need to be ON!

DISP2CEN and **CONT2ACT** signs are checked through a static test. **GEO2CEN** sign is later tested with a transfer functions measurements.

Test conditions

- Once populated, test the matrices by performing the following test
 - o Drive a 1000 counts positive offset in one direction by using the isolation filter bank (MEDM – ISI_HAM_CONT_Direction)
 - o Write down CPS readout (relative) in the table below
 - o Write down sensor readout in the general direction in the table below
 - o Compare signs with reference table

Matlab

A Matlab function is used to execute the “Static Testing (Tests in the Cartesian basis)”

Follow the steps below:

- 1- Open the Matlab script Sensor_Readout_Cartesian_Drive_MEDM_HAM_ISI.m located in the SVN at seisvn/seismic/HAM-ISI/X1/Scripts/Data_Collection/
- 2- Edit the data name (LHO_HAM-ISI_Unit_1_Cartesian_Drive_Date), edit the path (seisvn/seismic/HAM-ISI/X1/Data/Unit_1/Static_Tests)
- 3- Copy and paste the table in the test report as it is

Sensor_Readout_Offset_Cartesian_Drive_MEDM_HAM_ISI.m drives a 1000 counts positive offset on the local actuators and reads all the CPS sensors.

1000 counts Drive		X Drive	Y Drive	Z Drive	Rx Drive	Ry Drive	Rz Drive
Sensors readout (count)	H1						
	H2						
	H3						
	V1						
	V2						
	V3						
	Direction read out						

Table - Tests in the general coordinate basis

		X Drive	Y Drive	Z Drive	Rx Drive	Ry Drive	Rz Drive
Sensors readout (count)	H1	+	-				-
	H2	+	+				-
	H3	-	0				-
	V1			+	-	-	
	V2			+	+	+	
	V3			+	-	+	
	Direction read out	+	+	+	+	+	+

Table – Reference table

Acceptance criteria:

For a positive drive in the Cartesian basis:

- Local sensor readout must have the same sign that the reference table (**CONTACT check**)
- Cartesian sensors read out must be positive (**DISP2CEN check**) in the drive direction

The tests report must contain:

- 1- The table “Tests in the general coordinate basis”
- 2- If signs issues – report **CONTACT** and **DISP2CEN** used for this test
- 3- Issues/difficulties/comments regarding this test
- 4- Test result (Passed: ____ Failed: ____)

▪ *Step 16- Frequency response*

Transfer functions are measured via Matlab and awgstream. Measurements are launched with **Run_Exc_Batch_X1_HAM_ISI** and processed with **Run_Get_Batch_X1_HAM_ISI**. **Run_Exc_Batch_X1_HAM_ISI** calls Run_TF_L2L_XX or Run_TF_C2C_XX functions to start excitations. It creates the excitation file and the batch_file. The batch file is an “exchange file” that is read by **Run_Get_Batch_X1_HAM_ISI**. It carries general information such as data locations, data names, response channels, etc... The excitation file contains more specific data such as the excitation signals, GPS start time, frequency resolution, etc... Transfer functions are computed by **Run_Get_Batch_X1_HAM_ISI** and results are saved in structure file (1 per section).

In **Run_Exc_Batch_X1_HAM_ISI** and **Run_Get_Batch_X1_HAM_ISI**, locations of the data and the batch file (current + archive) have to be specified. Site, Unit, State (Undamped, Damped, Isolated ...) must be edited. Date is automatically added.

Note 1: The batch_file is erased at every new set of measurements. If the batch file has been overwritten, Run_get_batch_retrieve can be used to compute transfer functions. In that case, the batch_file_archive name must be edited in Run_get_batch_retrieve.

Note 2: The identification scripts calls the Schroeder phase scripts that are common to every subsystem (BSC-ISI, HAM-ISI, HEPI-BSC, HEPI-HAM). These scripts are located at the top of the SVN arborescence (svncommon/seisvn/seismic/Common/MatlabTools/Schroeder_Phase_Scripts)

Scripts used at LASTI to measure transfer functions are located in the SVN at:

seisvn/seismic/HAM-ISI/X1/Scripts/Data_Collection

- Run_Exc_Batch_X1_HAM_ISI.m
- Run_Get_Batch_X1_HAM_ISI.m
- Run_Get_Batch_Retrieve_X1_HAM_ISI.m
- Run_TF_L2L_10mHz_100mHz.m
- Run_TF_L2L_100mHz_1Hz.m
- Run_TF_L2L_1Hz_10Hz.m
- Run_TF_L2L_10Hz_100Hz.m
- Run_TF_L2L_100Hz_1000Hz.m
- HAM_ISI_exc_chan_list.m
- HAM_ISI_resp_chan_list.m

Batch_file location is specific for each Unit.

For instance, /seisvn/seismic/HAM-ISI/X1/Data/Transfer_Functions/Measurements and the archived batch file at /seisvn/seismic/HAM-ISI/X1/Data/Transfer_Functions/Measurements/Batch_file-Archive

Local to local and Cartesian to Cartesian transfer functions are measured between 0.05Hz and 800Hz (4 sections: 50mHz to 500mHz; 500mHz to 5Hz; 5Hz to 200Hz; 200mHz to 800Hz).

Batch Files are located in SVN at:

seisvn/seismic/HAM-ISI/X1/Data/Unit_1/Transfer_Functions/Measurements/

Run_Exc_batch.m calls Data collection script files to start excitation.

Data collection script files in the SVN at:

seisvn/seismic/HAM-ISI/X1/Scripts/Data_Collection

- Run_TF_L2L_50mHz_500mHz.m
- Run_TF_L2L_500mHz_5Hz.m
- Run_TF_L2L_5mHz_200Hz.m
- Run_TF_L2L_200Hz_800Hz.m
- Run_TF_C2C_50mHz_500mHz.m
- Run_TF_C2C_500mHz_5Hz.m
- Run_TF_C2C_5mHz_200Hz.m
- Run_TF_C2C_200Hz_800Hz.m
- Run_TF_C2C_10mHz_100mHz_LZMP.m

Depending on the type of measurements, the excitation list and the response channels list defer. Several channel lists have been defined.

Excitation channels and response channels list in the SVN at:

seisvn/seismic/HAM-ISI/X1/Scripts/Schroeder_Phase_Scripts

- HAM_ISI_exc_chan_list.m (Drive_List=1 for local to local - Drive_List=2 for Cartesian to Cartesian - Type=3 for LZMP)
- HAM_ISI_resp_chan_list.m (Channels_List=1 for local to local - Channels_List =2 Cartesian to Cartesian)

The table below presents the convention chosen for the excitation channels lists (type 1, 2, 3)

	#	1	2	3	4	5	6
type = 1	Actuator	H1	H2	H3	V1	V2	V3
type = 2	Actuator	X	Y	RZ	Z	RX	RY
type = 3	Actuator	X	Y				

Table – Excitation list

The table below presents the convention chosen for the response channels lists (type 1, 2)

	#	1	2	3	4	5	6	7	8	9	10	11	12
resplist = 1	Actuator	CPS H1	CPS H2	CPS H3	CPS V1	CPS V2	CPS V3	GS13 H1	GS13 H2	GS13 H3	GS13 V1	GS13 V2	GS13 V3
resplist = 2	Actuator	CPS X	CPS Y	CPS RZ	CPS Z	CPS RX	CPS RY	GS13 X	GS13 Y	GS13 RZ	GS13 Z	GS13 RX	GS13 RY

Table – Response channel list

Parameters to define before starting measurements

- Define/Check autosave path (X1 or X1) in Run_Exc_Batch_X1_HAM_ISI.m and Run_Get_Batch_X1_HAM_ISI.m
- Define/Check autosave name in Data collection scripts
- Add/Edit comments (date - configuration – Number of repetitions)
- Folders in which the data are stored must be created.

How to use Run_Exc_Batch_X1_HAM_ISI.m and Run_Get_Batch_X1_HAM_ISI.m?

- Open one matlab session and run “Run_Exc_Batch_X1_HAM_ISI.m”. This script creates a batch_file (in Data/Transfer Functions), start excitations and store excitation files stored in Data/Transfer Functions/Measurements/Subfolder (Subfolder can be Undamped, Damping, Isolation, Super Sensors)
- Run_Get_Batch_X1_HAM_ISI reads the batch file and computes transfer functions section by section and stored results in one of the subfolder mentioned above.
- Once Run_Exc_Batch_X1_HAM_ISI is done and Run_Get_Batch_X1_HAM_ISI is waiting for new results, kill Run_Exc_Batch_X1_HAM_ISI.m with a “Ctrl + C” in Matlab command window.
- The number of repetition for measurement is defined in Run_Exc_Batch_X1_HAM_ISI.m Quick tests with 1 or 2 repetitions are advised before running the whole measurement.

How to get the transfer functions?

- Each data folders mentioned above must contain one script file that processes the data (concatenate 4 sections and plot transfer functions and/or compute LZMP). Use the one from previous unit
- Date label the script file use to process data
- In the script files, edit title, input/output (last line) data. Two variables that can be edited:
 - o **plot_with_HAM6** = 0 (to display measurements without HAM6) or 1 (to display measurements with HAM6)
 - o **Automatic_plot_saving** = 0 (save nothing) or 1 (to automatically save figures in the appropriated figure folder)
- Run it. **(to save figures automatically, every scripts must be run from the folder in which they are located (Data/Transfer_Functions/Undamped))**
- Main results of the measurement are stored in a .mat files

.mat files contain:

- Transfer functions and coherences are stored in a 3D matrix (sensor, actuator, frequency)
- Saturation section by section

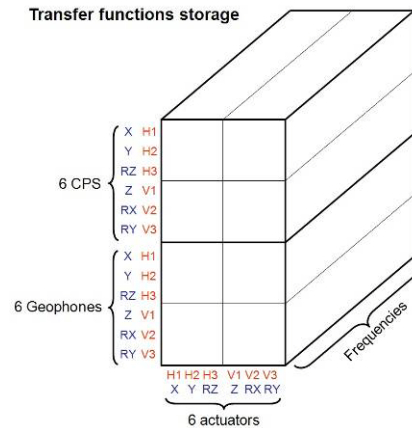

Figure – Transfer functions storage

▪ **Step 16.1 - Local to local measurements**

The table below summarizes the data acquisition parameters used for the local to local measurements. The advised number of repetitions is 90 but for quick measurements 30 repetitions are sufficient (at night in LHO).

Run #	1	2	3	4
Fmin	0.05 Hz	0.5 Hz	5 Hz	200
Fmax	0.5 Hz	5 Hz	200 Hz	800
F Res	0.05Hz	0.05 Hz	0.1 Hz	0.1
N rep	30 - 90	30 - 90	30 - 90	30 - 90
H1 Drive Amp	550 Cts	100 Cts	6000 Cts	7000 Cts
H2 Drive Amp	550 Cts	100 Cts	6000 Cts	7000 Cts
H3 Drive Amp	550 Cts	100 Cts	6000 Cts	7000 Cts
V1 Drive Amp	550 Cts	50 Cts	6000 Cts	7000 Cts
V2 Drive Amp	550 Cts	50 Cts	6000 Cts	7000 Cts
V2 Drive Amp	550 Cts	50 Cts	6000 Cts	7000 Cts
Est Duration	70 - 210mn	60 - 180mn	40 - 120mn	40 - 120mn

Table - Measurement parameters – Local to local

Data collection script files are in the SVN at:

seisvn/seismic/HAM-ISI/X1/Scripts/Data_Collection

- Run_TF_L2L_50mHz_500mHz.m
- Run_TF_L2L_500mHz_5Hz.m
- Run_TF_L2L_5mHz_200Hz.m
- Run_TF_L2L_200Hz_800Hz.m

Procedure to follow for this test:

- Run Run_Exc_Batch_X1_HAM_ISI.m (Define the number of repetitions) and Run_Get_Batch_X1_HAM_ISI.m
- Date label the script file use to process data and place into the data folder

- In the script file, edit title, input/output data.

Example of SVN path with HAM-ISI-LLO-Unit-1

Data files measurement of local to local transfer functions in SVN at:

seisvn/seismic/HAM-ISI/X1/Data/Unit_1/Transfer_Functions/Measurements/Undamped/

- LHO_HAM_ISI_Unit_1_Data_TF_L2L_50mHz_500mHz_DATE.mat
- LHO_HAM_ISI_Unit_1_Data_TF_L2L_500mHz_5Hz_DATE.mat
- LHO_HAM_ISI_Unit_1_Data_TF_L2L_5_200Hz_DATE.mat
- LHO_HAM_ISI_Unit_1_Data_TF_L2L_200_800Hz_DATE.mat

Script file for processing and plotting local to local transfer functions in SVN at:

seisvn/seismic/HAM-ISI/X1/Data/Unit_1/Transfer_Functions/Measurements/Undamped/

- Plot_LHO_HAM_ISI_Unit_1_TF_L2L_DATE.m (set plot_with_HAM6 to 0)

Figures of local to local transfer functions in SVN at:

seisvn/seismic/HAM-ISI/X1/Data/Unit_1/Figures/Transfer_Functions/Measurements/Undamped/

- LHO_HAM_ISI_Unit_1_TF_L2L_H_CPS_50mHz_800Hz_DATE.fig
- LHO_HAM_ISI_Unit_1_TF_L2L_V_CPS_50mHz_800Hz_DATE.fig
- LHO_HAM_ISI_Unit_1_TF_L2L_H_GS13_50mHz_800Hz_DATE.fig
- LHO_HAM_ISI_Unit_1_TF_L2L_V_GS13_50mHz_800Hz_DATE.fig

Measured of local to local transfer functions in the SVN at:

seisvn/seismic/HAM-ISI/X1/Data/Unit_1/Transfer_Functions/Measurements/Undamped/

- LHO_HAM_ISI_Unit_1_Data_TF_L2L_50mHz_800Hz_DATE.mat

▪ **Step 16.2 - Cartesian to Cartesian measurements**

The table below summarizes the data acquisition parameters used for the Cartesian to Cartesian. The advised number of repetitions is 90 but for quick measurements 30 repetitions are sufficient (at night in LHO).

Run #	1	2	2	3
Fmin	0.05 Hz	0.5 Hz	5 Hz	200
Fmax	5 Hz	5 Hz	200 Hz	800
F Res	0.05 Hz	0.05 Hz	0.1 Hz	0.1
N rep	30 - 90	30 - 90	30 - 90	30 - 90
X Drive Amp	550 Cts	75 Cts	6000 Cts	7000 Cts
Y Drive Amp	550Cts	75 Cts	6000 Cts	7000 Cts
RZ Drive Amp	550 Cts	35 Cts	6000 Cts	7000 Cts
Z Drive Amp	550 Cts	75 Cts	6000 Cts	7000 Cts
RX Drive Amp	550 Cts	20 Cts	6000 Cts	7000 Cts
RY Drive Amp	550 Cts	20 Cts	6000 Cts	7000 Cts
Est Duration	70 - 210mn	60 - 180mn	40 - 120mn	40 - 120mn

Table - Measurement parameters – Cartesian to Cartesian

Procedure to follow for this test:

- Run Run_Exc_batch and Run_Get_batch
- Date label the script file use to process data and place into the data folder
- In the script file, edit title, input/output data.

Example of SVN path with HAM-ISI-LHO-Unit-1**Data collection script files in SVN at:**

seisvn/seismic/HAM-ISI/X1/Scripts/Data_Collection

- Run_TF_C2C_50mHz_500mHz.m
- Run_TF_C2C_500mHz_5Hz.m
- Run_TF_C2C_5mHz_200Hz.m
- Run_TF_C2C_200Hz_800Hz.m

Data files of cartesian to cartesian measurement transfer functions in SVN at:

seisvn/seismic/HAM-ISI/X1/Data/Unit_1/Transfer_Functions/Measurements/Undamped

- LHO_HAM_ISI_Unit_1_Data_TF_C2C_50mHz_500mHz_DATE.mat
- LHO_HAM_ISI_Unit_1_Data_TF_C2C_500mHz_5Hz_DATE.mat
- LHO_HAM_ISI_Unit_1_Data_TF_C2C_5_200Hz_DATE.mat
- LHO_HAM_ISI_Unit_1_Data_TF_C2C_200_800Hz_DATE.mat

Script file for processing and plotting cartesian to cartesian transfer functions in SVN at:

seisvn/seismic/HAM-ISI/X1/Data/Unit_1/Transfer_Functions/Measurements/Undamped

- Plot_LHO_HAM_ISI_Unit_1_TF_C2C_DATE.m

Figures of Cartesian to Cartesian transfer functions in SVN at:

seisvn/seismic/HAM-ISI/X1/Data/Unit_1/Figures/Transfer_Functions/Measurements

- LHO_HAM_ISI_Unit_1_TF_C2C_X_Y_RZ_CPS_50mHz_800Hz_DATE.fig
- LHO_HAM_ISI_Unit_1_TF_C2C_X_Y_RZ_GS13_50mHz_800Hz_DATE.fig
- LHO_HAM_ISI_Unit_1_TF_C2C_Z_RX_RY_CPS_50mHz_800Hz_DATE.fig
- LHO_HAM_ISI_Unit_1_TF_C2C_Z_RX_RY_GS13_50mHz_800Hz_DATE.fig

Measured Cartesian to Cartesian transfer functions in the SVN at:

seisvn/seismic/HAM-ISI/X1/Data/Unit_1/Transfer_Functions/Measurements/Undamped

- LHO_HAM_ISI_Unit_1_Data_TF_C2C_50mHz_800Hz_DATE.mat

Acceptance criteria:

- Local to local measurements
 - o On CPS, the phase must be 0° at DC
 - o On Geophones, the phase must be -90° at DC
 - o Identical shape in each corner
- Cartesian to Cartesian measurements
 - o On CPS, the phase must be 0° at DC
 - o On Geophones, the phase must be -90° at DC
 - o Identical shape X/Y and RX/RX

The tests report must contain:**1- Figures of local to local measurements**

- o Local to local vertical position sensors transfer functions
- o Local to local horizontal position sensors transfer functions
- o Local to local vertical geophones transfer functions
- o Local to local horizontal geophones transfer functions

2- Path in SVN of local to local measurements

- o Data (4 sections)
- o Scripts used for processing
- o Figures
- o Data storage (concatenate)

3- Figures of Cartesian to cartesian measurements

- o Cartesian to Cartesian vertical position sensors transfer functions
- o Cartesian to Cartesian horizontal position sensors transfer functions
- o Cartesian to Cartesian vertical geophones transfer functions
- o Cartesian to Cartesian horizontal geophones transfer functions

4- Path in SVN of Cartesian to Cartesian measurements

- o Data (4 sections)
- o Scripts used for processing
- o Figures
- o Data storage (concatenate)

5- Issues/difficulties/comments regarding this test**6- Test result (Passed: ____ Failed: ____)**

▪ ***Step 17 - Transfer function comparison with Reference***

Procedure to follow for this test:

In this test, we only run the same plotting scripts as in the previous step

- Plot_ [LHO_HAM_ISI_Unit_1_TF_L2L_DATE.m](#)
- Plot_ [LHO_HAM_ISI_Unit_1_TF_C2C_DATE.m](#)

editing them on line 19 `Plot_with_Ref=1;`

NB: starting May 2011, the reference to compare the transfer functions against is LHO Unit #2

This will re-plot the same data as the previous step, with the reference results, and compare the main resonances.

Reference main results (3D matrix format) are located in the SVN at:

`/svn/seismic/HAM-ISI/X1/Data/Old_Unit_2/Transfer_functions/Local_to_local/`

- `Local_2_Local_LHO_HAM-ISI-Unit_2_2010_09_16.mat`

`/svn/seismic/HAM-ISI/X1/Data/Old_Unit_2/Transfer_functions/Cartesian_to_cartesian/`

- `Cartesian_2_Cartesian_LHO_HAM-ISI-Unit_2_2010_08_28.mat`

▪ ***Step 17.1 - Local to local - Comparison with Reference***

Example of SVN path with HAM-ISI-LHO-Unit-1

Script files for processing and plotting transfer functions are located in the SVN at:

`seisvn/seismic/HAM-ISI/X1/Data/Unit_1/Transfer_Functions/Measurements/Undamped/`

- Plot_ [LHO_HAM_ISI_Unit_1_TF_L2L_DATE.m](#) (with `plot_with_HAM6` set to 1)

The tests report must contain:

1- Figures of local to local measurements

- Local to local vertical position sensors transfer functions
- Local to local horizontal position sensors transfer functions
- Local to local vertical geophones transfer functions
- Local to local horizontal geophones transfer functions

2- Path in SVN of local to local measurements

- Figures

3- Report main differences with Reference

4- Issues/difficulties/comments regarding this test

▪ ***Step 17.2 - Cartesian to Cartesian - Comparison with Reference***

Example of SVN path with HAM-ISI-LHO-Unit-1

Script files for processing and plotting transfer functions are located in the SVN at:

`seisvn/seismic/HAM-ISI/X1/Data/Unit_1/Transfer_Functions/Measurements/Undamped/`

- Plot_ [LHO_HAM_ISI_Unit_1_TF_C2C_DATE.m](#) (with `plot_with_HAM6` set to 1)

Acceptance criteria:

- No difference with the reference transfer functions (SVN)
 - Phase – less than 10° - In Phase – Out of Phase

- Damping (fit by eye with Reference transfer functions)
- DC gain
- Eigen frequencies shift less than 10%

The tests report must contain:

1- Figures of local to local measurements

- Cartesian to Cartesian vertical position sensors transfer functions
- Cartesian to Cartesian horizontal position sensors transfer functions
- Cartesian to Cartesian vertical geophones transfer functions
- Cartesian to Cartesian horizontal geophones transfer functions

2- Path in SVN of Cartesian to Cartesian measurements

- Figures

3- Report the main differences with Reference

4- Issues/difficulties/comments regarding this test

5- Test result (Passed: ____ Failed: ____)

▪ **Step 18 - Lower Zero Moment Plane**

This test aims at measuring the distance between the horizontal actuator plane and the lower zero moment plane. That distance is calculated from Cartesian to Cartesian transfer functions measured at low frequencies between 10mHz and 100mHz.

Procedure to follow for this test:

- Run Run_Exc_Batch_X1_HAM_ISI.m and Run_Get_Batch_X1_HAM_ISI.m to lunch to LZMP measurements with Run_TF_C2C_10mHz_100mHz_LZMP.m
- Date label the script file use to process data
- In the script file, edit title, input/output data.

Data collection script files used for this measurement is located in the SVN at:

seisvn/seismic/HAM-ISI/X1/Scripts/Data_Collection

- Run_TF_C2C_10mHz_100mHz_LZMP.m

Example of SVN path with HAM-ISI-LHO-Unit-1

Data files in SVN at:

seisvn/seismic/HAM-ISI/X1/Data/Unit_1/Transfer_Functions/Undamped

- LHO_HAM_ISI_Unit_1_Data_TF_C2C_10mHz_100mHz_LZMP_DATE.mat

Scripts files for processing and plotting in SVN at:

seisvn/seismic/HAM-ISI/X1/Data/Unit_1/Transfer_Functions/Undamped

- Plot_LHO_HAM_ISI_Unit_1_TF_C2C_10mHz_100mHz_LZMP_DATE.m

Figures in SVN at:

seisvn/seismic/HAM-ISI/X1/Data/Unit_1/Figures/Transfer_Functions/Undamped

- LHO_HAM_ISI_Unit_1_LZMP_DATE.fig

To compute the LZMP, use the spring constants from Final Review Document defined in “Nov 13, 2007 LIGO+HPD eLog entry 287”

The table below summarizes the data acquisition parameters used for the Cartesian to Cartesian. The advised number of repetitions is 200 but for quick measurements 100 repetitions are sufficient.

Run #	1
Fmin	0.01 Hz
Fmax	0.1 Hz
F Res	0.01 Hz
N rep	100 - 200
X Drive Amp	4000Cts
Y Drive Amp	4000Cts
Est Duration	mm

Table - Measurement parameters – Cartesian to Cartesian

Report the LZMP offsets in the table

X offset (mm)	
Y offset (mm)	

Table – Offset of the Lower Zero Moment Plane

Acceptance criteria:

- X offset must be less than 2 mm
- Y offset must be less than 2 mm

The tests report must contain:

- 1- **Figure of Cartesian to Cartesian measurements (X to X, Y to Y, X to RY, Y to RX)**
- 2- **Path in SVN of Cartesian to Cartesian measurements**
 - Data
 - Scripts used for processing
 - Figures
- 3- **The Table “Offset of the lower zero moment plan”**
- 4- **Issues/difficulties/comments regarding this test**
- 5- **Test result (Passed: ____ Failed: ____)**

▪ *Step 19 - Damping loops*

In this step, HAM6 damping loops are implemented. First, damping performances are evaluated in simulation. Second, Damping loops are implemented and performance is experimentally measured.

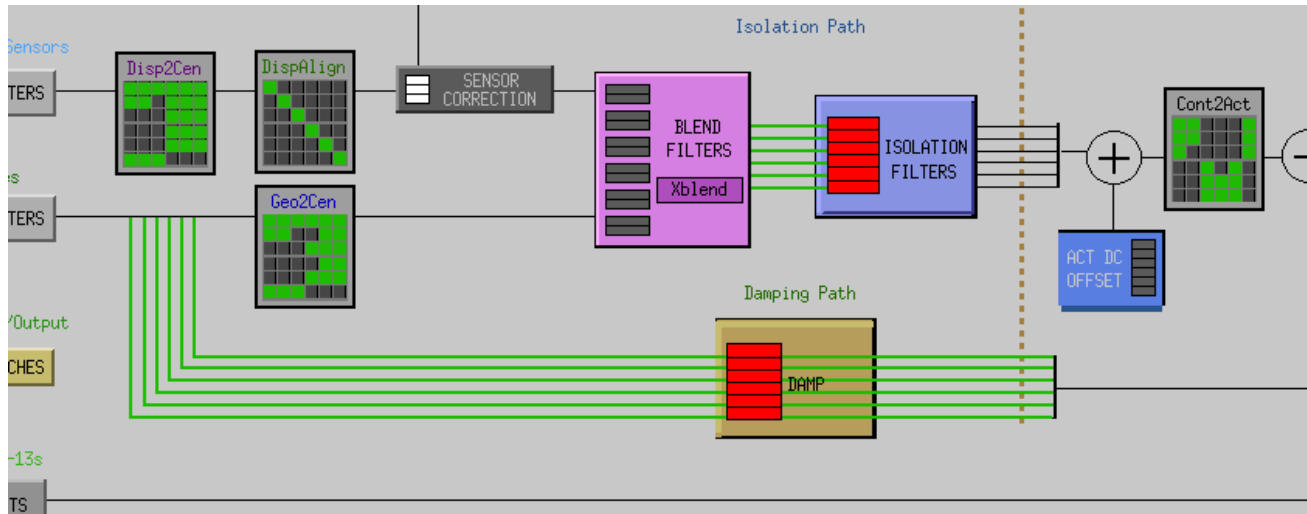

Figure – Turn damping loops on!

Note that usually a gain of -1 is necessary for stable damping loops!

▪ *Step 19.1 - Transfer functions - Simulation*

Continuous HAM6 filters are located in the SVN at:

/optseisvn/seismic/HAM-ISI/Common/HAM6_Main_Results

- HAM6_LLO_Damping_Filters.mat

Procedure to follow for this test:

- Open the script file **LHO_HAM_ISI_Unit_1_Damping_TF_DATE**) in /seismic/HAM-ISI/X1/Data/Unit_1/Transfer_Functions/Simulations/Damping
- Date label the script file
- In the script file, edit title, input/output data
- Run it

This script creates a .mat files in which the plant, open loops, closed loops, suppression are stored in 3D matrices. This script also plots figures that present the plant, controller, open loop, closed loop and sensitivity of vertical and horizontal damping loops.

On figures that show the three vertical or horizontal damping loops on the same plot, the line style code is:

- 1- H1/V1 are plotted in solid line
- 2- H2/V2 are plotted in dash line
- 3- H3/V3 are plotted in dash-dot line

The following plots are presented using the convention below:

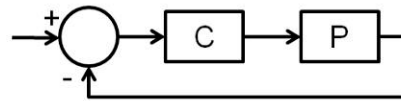

Figure – Feedback loop

Example of SVN path with HAM-ISI-LHO-Unit-1

Scripts files used to evaluate damping loops performance from measurements are located in SVN at:

/ seismic/HAM-ISI/X1/Data/Unit_1/Transfer_Functions/Simulations
LHO_HAM_ISI_Unit_1_Damping_TF_DATE.m

Save file is located in the SVN at:

/seismic/HAM-ISI/X1/Data/**Unit_1**/Transfer_Functions/Simulations
 - **LHO_HAM_ISI_Unit_1_Damping_TF_DATE.mat**

Figures in SVN at:

seismic/HAM-ISI/X1/Data/**Unit_1**/Figures/Damping_Loops
 - **LHO_HAM_ISI_Unit_1_Damping_TF_Horizontals_DATE.fig**
 - **LHO_HAM_ISI_Unit_1_Damping_TF_Verticals_DATE.fig**

Acceptance criteria:

- HAM6 damping loops must implemented and stable with
 - o Phase margin must be at least 45°
 - o Gain margin must be at least 20dB

The tests report must contain:

- 1- **Figures Damping loop (horizontal and vertical filters)**
- 2- **Path in SVN of Cartesian to Cartesian measurements**
 - o Data
 - o Scripts used for processing
 - o Figures
- 3- **Issues/difficulties/comments regarding this test**
- 4- **Test result (Passed: ___ Failed: ___)**

▪ *Step 19.2 - Powerspectra – Experimental*

Once the stability has been verified in simulation, the HAM6 digital damping filters can be loaded in the MEDM filter bank. The filter file “G1ISIHAM.txt” is located in /opt/rtdcs/geo/g1/chans. Don’t forget to create back-up files if you modify digital filters. Filters have to be reloaded in the MEDM filter ban by **pressing load coefficients**.

Matlab

A first Matlab function is used to plot the power spectra of the Geophones when the table is in the undamped and the damped position. A second Matlab function is used to compare the experimental and the simulated suppression

Follow the steps below:

- 1- Write down the GPS Time once the table is undamped.
- 2- Wait for 35 minutes or reuse the GPS time of Step 8 if you can still access the data in the frame builder
- 3- Proceed for every corner.
- 4- Open the script Powerspectra_Measurement_HAM_ISI_Undamped_Damped.m located in the SVN at seisvn/seismic/HAM-ISI/X1/Scripts/Data_Collection/.
- 5- Edit the GPS time for the two different configurations and run the script. Edit autosave plot to 1)
- 6- Paste the figures in the report
- 7- Open the script LHO_HAM_ISI_Unit_1_Damping_Powerspectra_DATE.m located in the SVN at seisvn/seismic/HAM-ISI/X1/Data/Unit_1/Powerspectra/Damping/
- 8- Edit figure title, unit ID, date, input data (Simulated transfer functions,) and run the script. Edit autosave plot to 1)
- 9- Run the script and paste the figures in the report

Example of SVN path with HAM-ISI-LHO-Unit-1

Filters used by Damping loops in SVN at:

seisvn/seismic/HAM-ISI/X1/Data/Unit_1/

- G1ISIHAM_LHO_Unit_1_DATE.txt (digitalized filters copied and rename to G1ISIHAM.txt in /opt/rtdcs/geo/g1/chans)
- HAM6_LHO_Damping_Filters.mat (continuous filters)

Scripts files for processing and plotting in SVN at:

seisvn/seismic/HAM-ISI/X1/Scripts/Data_Collection

Powerspectra_Measurement_HAM_ISI_Undamped_Damped.m

seisvn/seismic/HAM-ISI/X1/Data/Unit_1/ Powerspectra/Damping/

LHO_HAM_ISI_Unit_3_Damping_Powerspectra_DATE.m

Data files in SVN at:

seisvn/seismic/HAM-ISI/X1/Data/Unit_1/ Powerspectra/Damping/

LHO_HAM_ISI_Unit_1_Calibrated_PSD_CPS_GS13_Undamped_Damped_DATE.mat

Figures in SVN at:

seisvn/seismic/HAM-ISI/X1/Data/Unit_1/Figures/ Powerspectra/Damping/

- LHO_HAM_ISI_Unit_1_Calibrated_PSD_GS13_Undamped_Damped_DATE.fig
- LHO_HAM_ISI_Unit_1_Suppression_Exp_vs_Sim_DATE.fig

Acceptance criteria:

- HAM6 damping loop must stable when all damping loops are engaged
- Similar damping effect than in simulated plots

The testing document must contain:

- 1- **Figures of Damping loops controller (vertical and horizontal)**
- 2- **Figures of suppression Measurement vs simulation vs HAM6**
- 3- **Path in SVN of Cartesian to Cartesian measurements**
 - o Data
 - o Scripts used for processing
 - o Figures
- 4- **Issues/difficulties/comments regarding this test**
- 5- **Test result (Passed: ____ Failed: ____)**

Appendix A: Dial indicators location

In order to ensure repeatable measurements from one unit to another, dial indicators have to be installed properly in the right locations. This section describes how to do it.

Dial indicators are used to monitor actual table motions & offer a back-up position measurement to the Capacitive Position Sensors. Breadboards on Stage 0 are used to mount the dial indicators. Dial indicators should resolve to at least 0.001". Try to avoid using complicated or long mounting hardware; we do not want to have the Dial Indicator mounted on a long post and possibly being easily "bump-able".

We have chosen to use horizontal & vertical dial indicators near each of our four Lockers. The vertical dial indicator registers on a bottom surface of Stage 1. The horizontal dial indicator registers on one of the radial surfaces on the Top Mount of the Locker.

Dial indicators should be pulled away from the ISI system when one wants to take noise measurements.

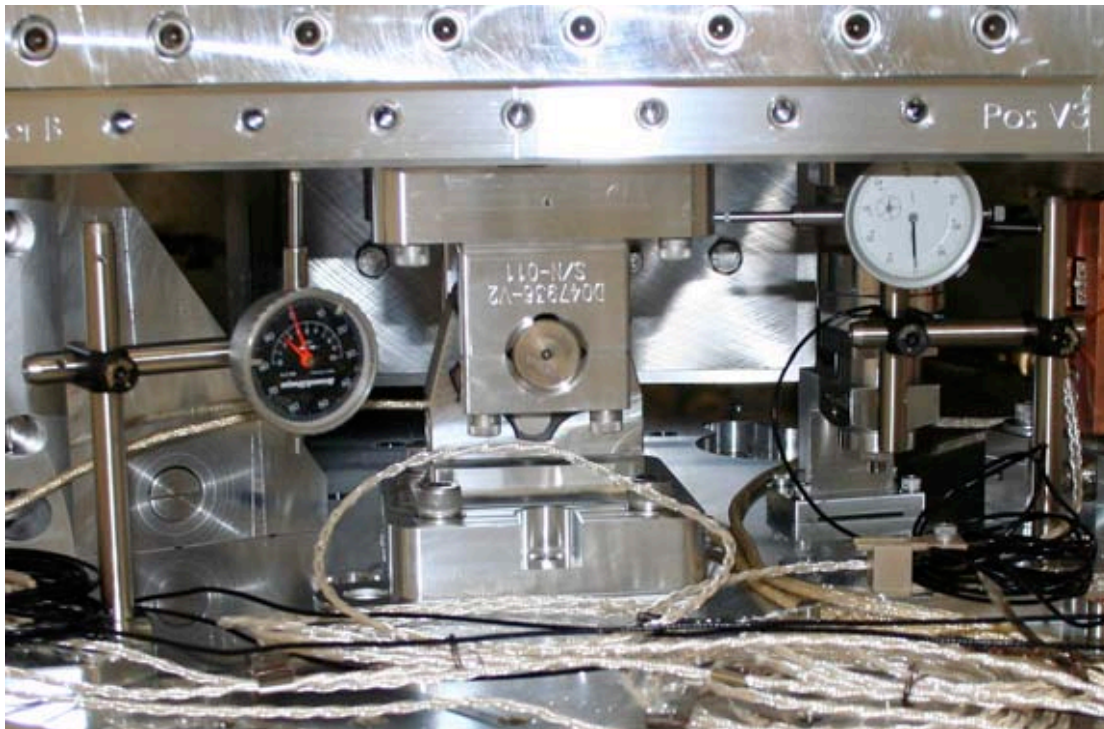

Figure - Vertical & Horizontal dial indicators installed near locker B

Dial indicators positions are presented in the figure below (blues dots and blue lines). Horizontal dial indicators A & C read negative for CCW rotation of Stage1 wrt Stage 0 whereas B & D read negative for CW rotation.

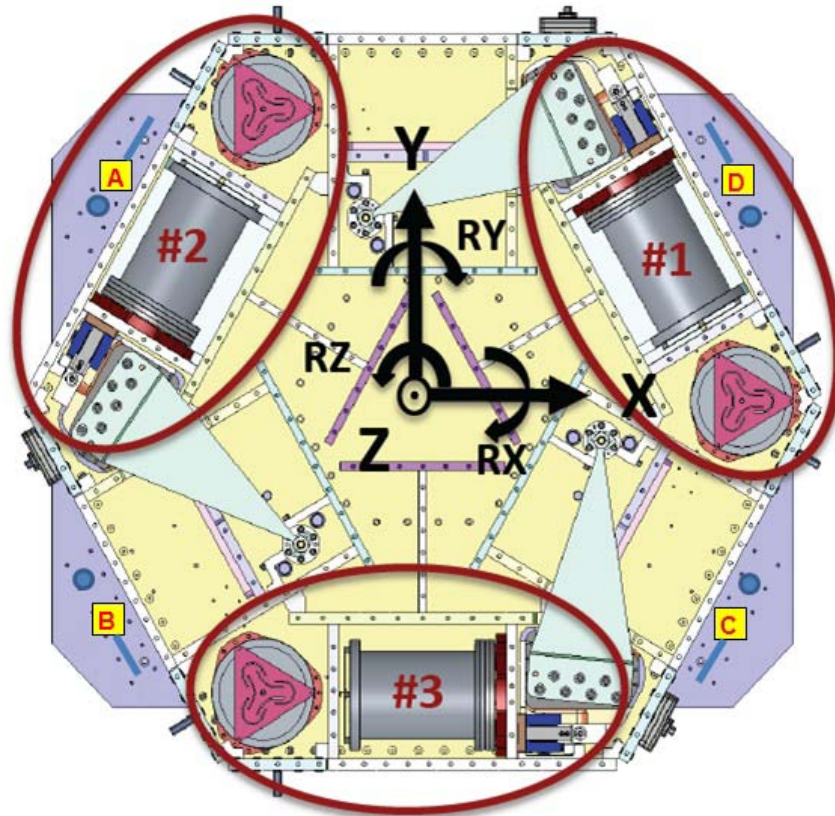

Figure - Top view of the HAM-ISI

Appendix B: Sensor calibration

Filter Notation

[zero (Hz) : pole (Hz) : dcGain]

HAM ISI - TEST STAND

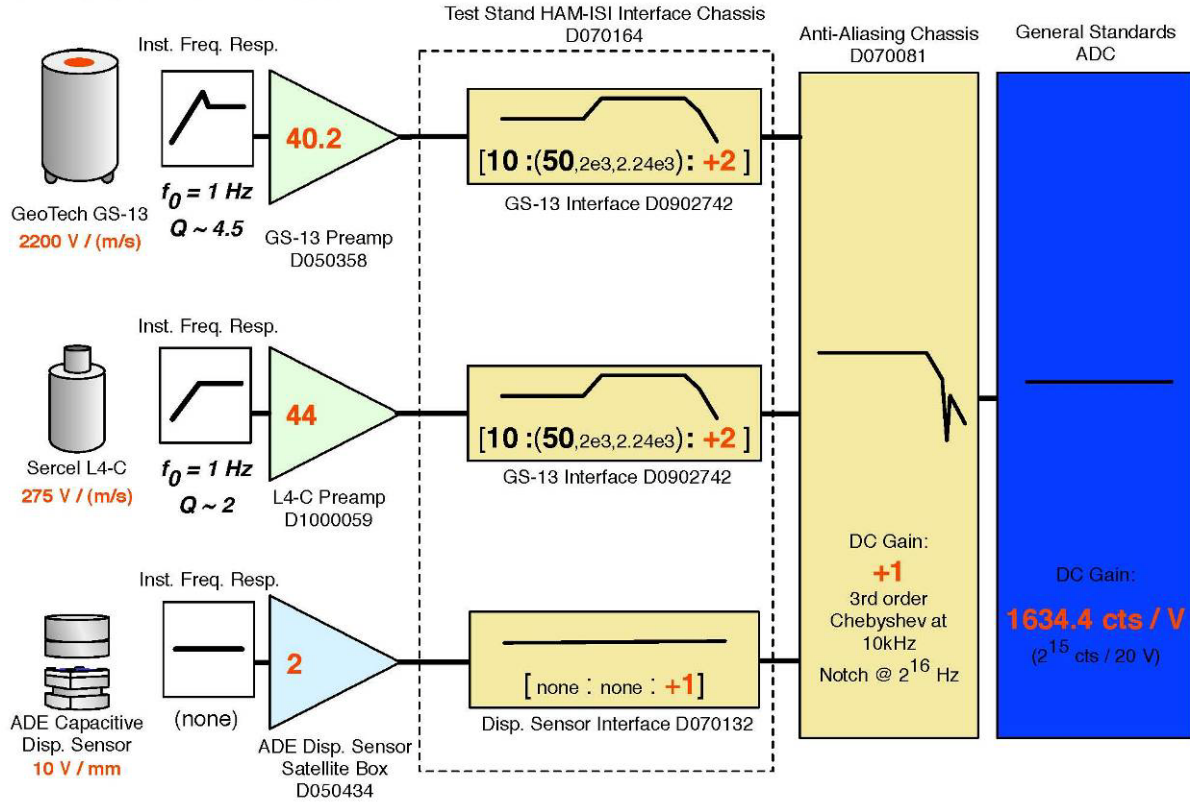

Appendix C: SVN arborescence

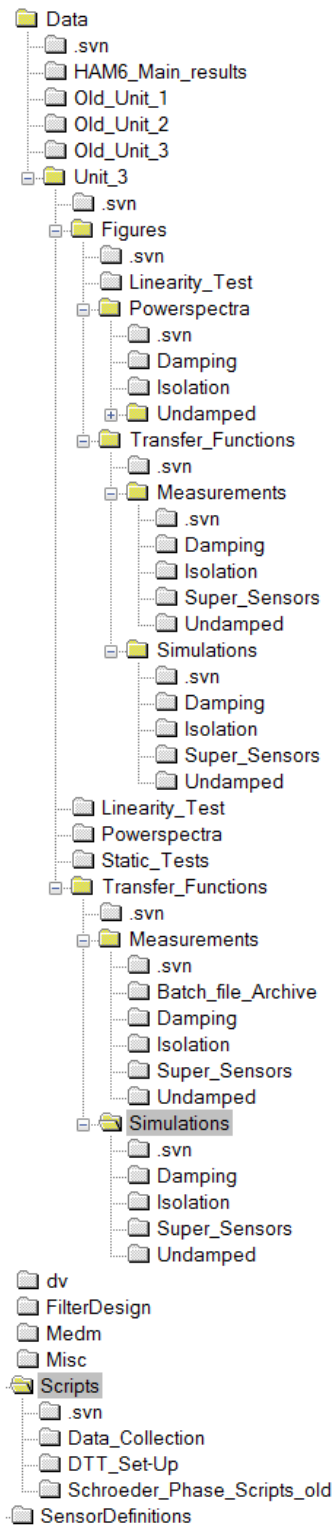

Figure - SVN arborescence

Appendix D: Matrices

- **GEO2CEN** : from local to Cartesian (GS13 Geophones)
- **DISP2CEN** : from local to Cartesian (Capacitive displacement sensors)
- **CONT2ACT** : from cartesian to local (Actuators)

For example, **CONT2ACT** matrix is the following matrix

	X	Y	Z	RX	RY	RZ
H1	0.333	-0.577	0	0	0	-0.431
H2	0.333	0.577	0	0	0	-0.431
H3	-0.667	0	0	0	0	-0.431
V1	0	0	0.333	0	-0.937	0
V2	0	0	0.333	0.812	0.469	0
V3	0	0	0.333	-0.812	0.469	0

with Local_vector = **CONT2ACT** x Cartesian_vector

DISP2CEN is the following matrix

	H1	H2	H3	V1	V2	V3
X	0.333	0.333	-0.667	-0.194	0.049	0.145
Y	-0.577	0.577	0	0.056	-0.196	0.140
Z	0	0	0	0.333	0.333	0.333
RX	0	0	0	-0.273	0.961	-0.688
RY	0	0	0	-0.952	0.240	0.712
RZ	-0.422	-0.422	-0.422	0	0	0

with Cartesian_vector = **DISP2CEN** x Local_vector