

This document and the design it covers are the property of PARSONS. They are loaned only with the borrower's expressed written agreement that they will not be reproduced, copied, loaned, exhibited, or used in any other way, except by written consent from PARSONS to the borrower.

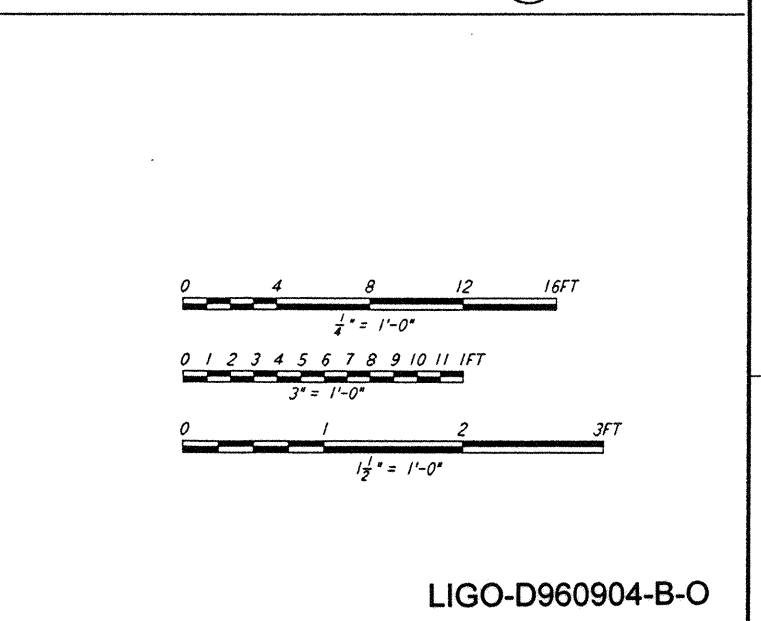
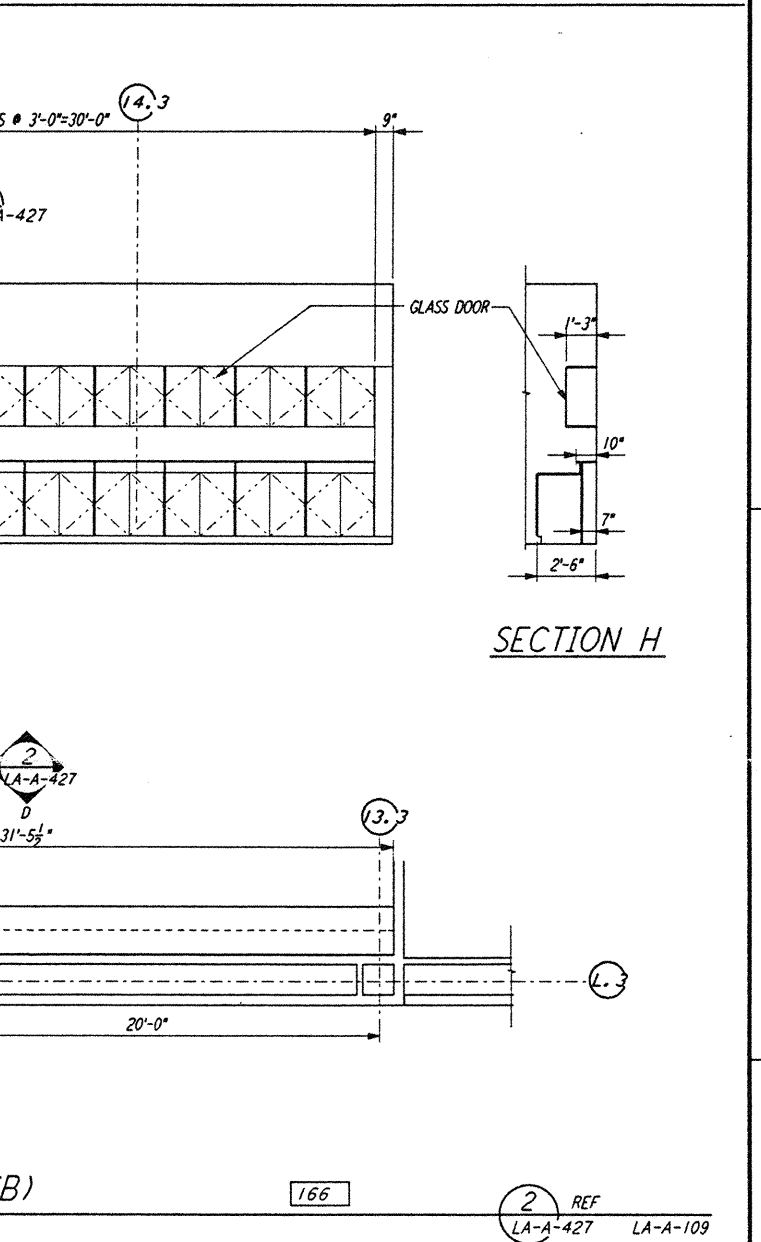
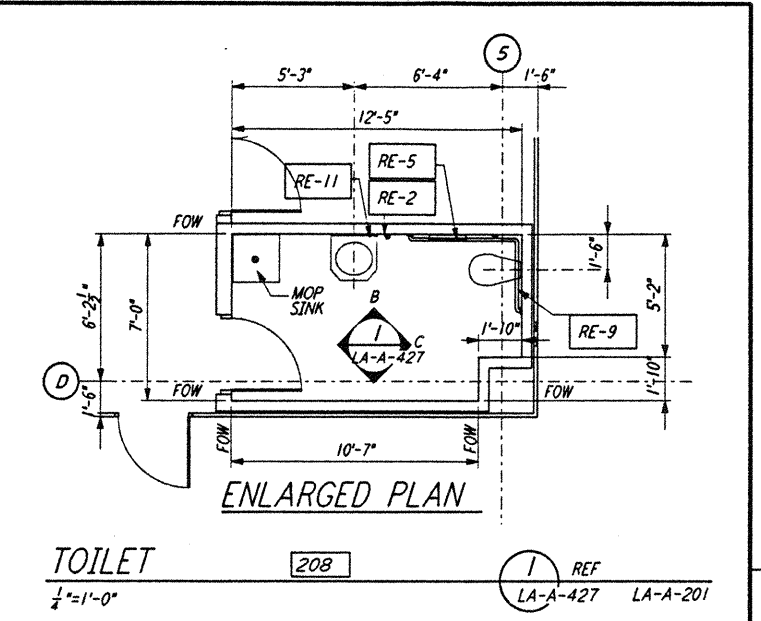
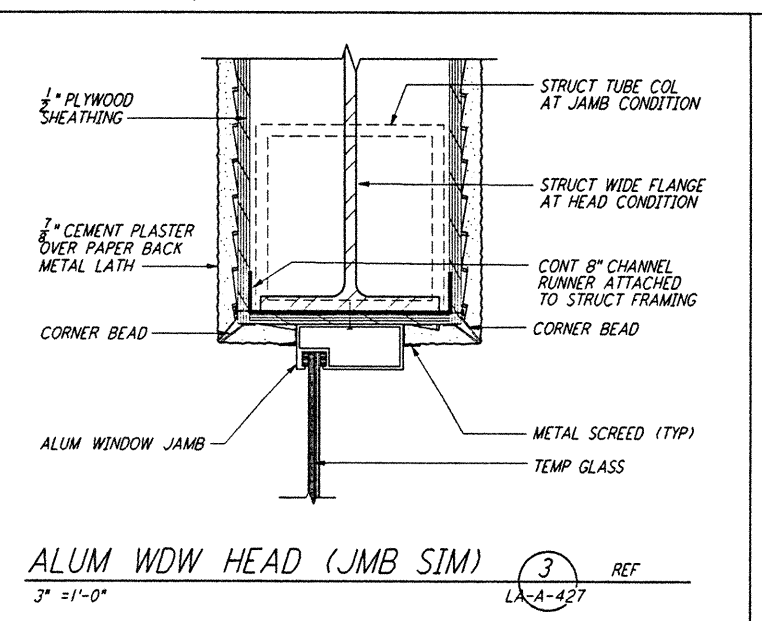
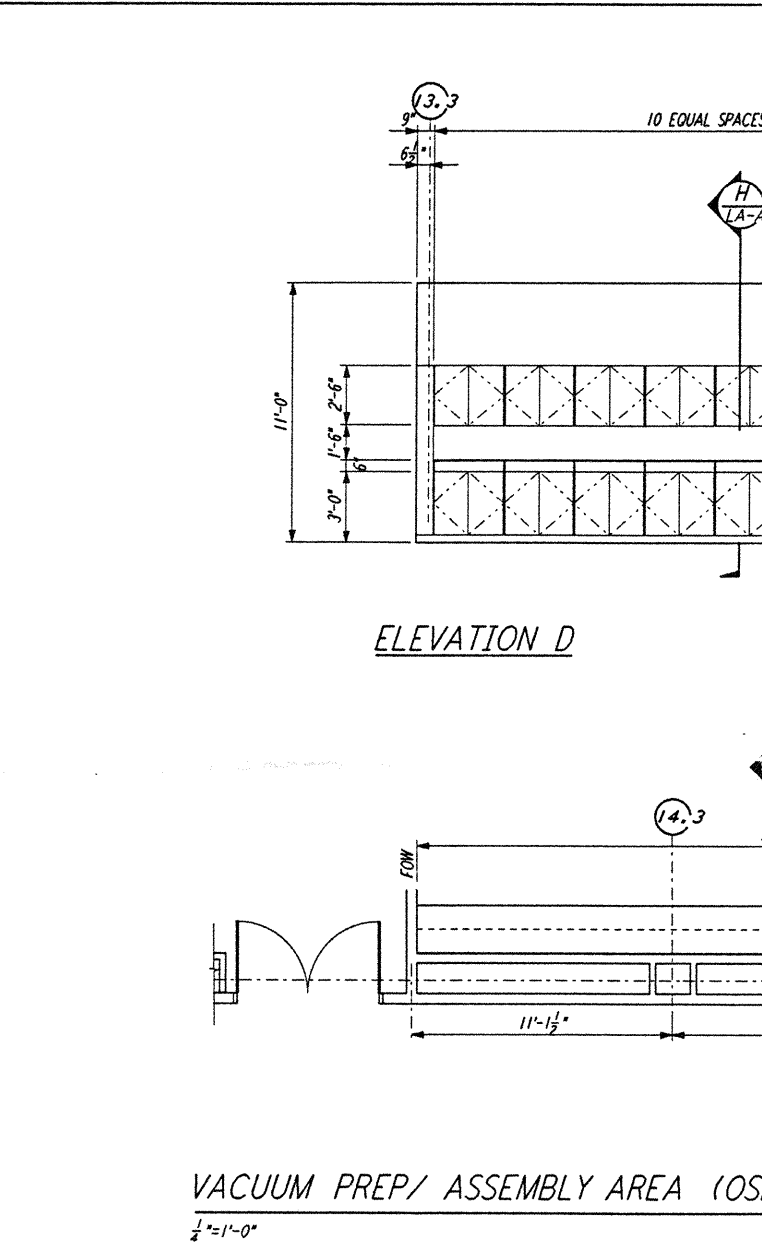
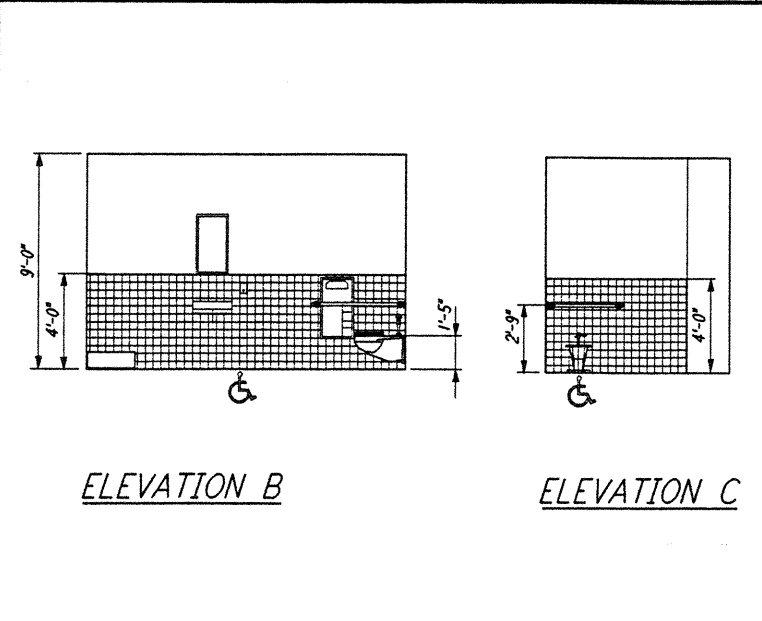
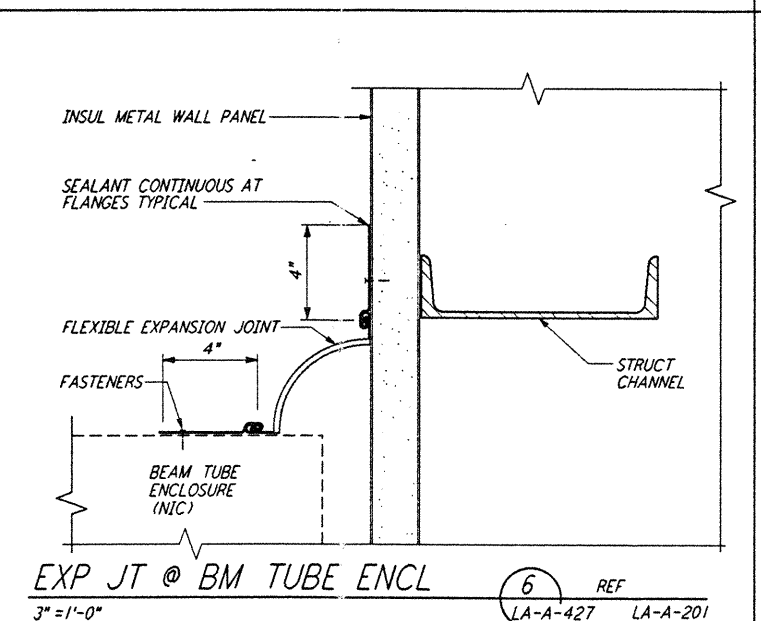
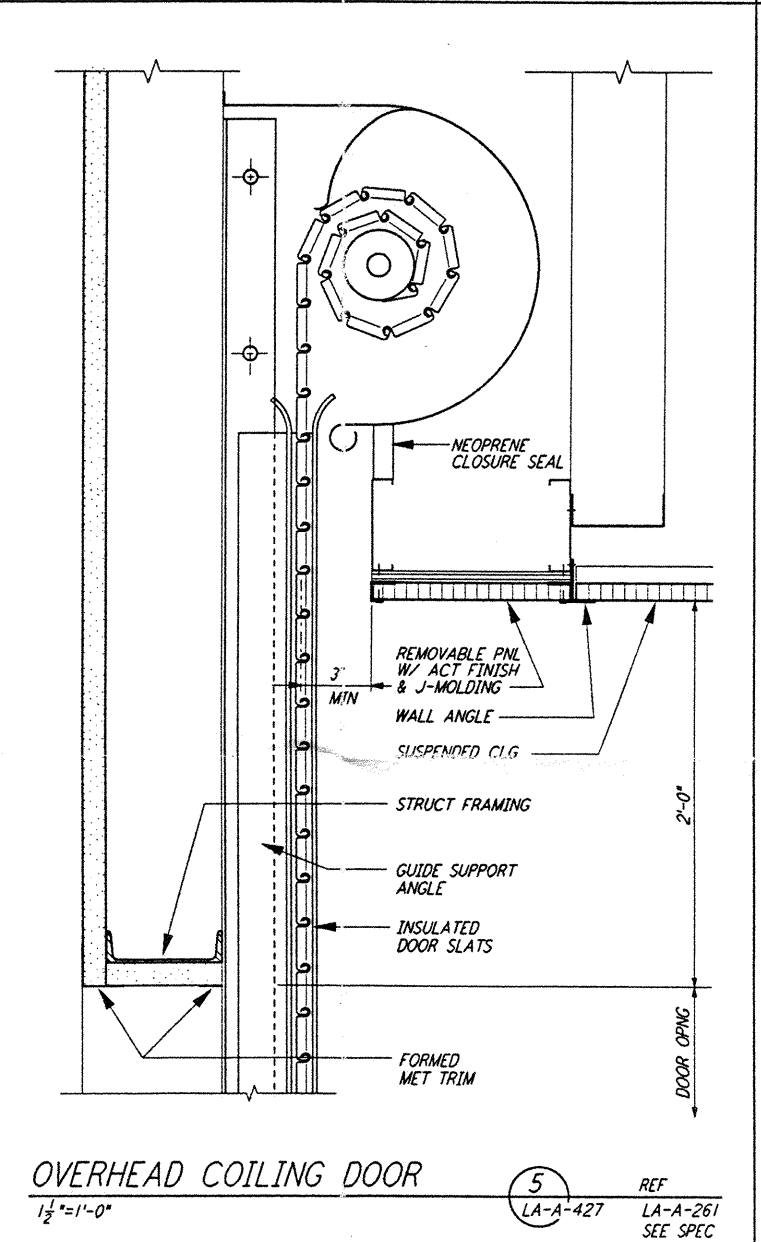
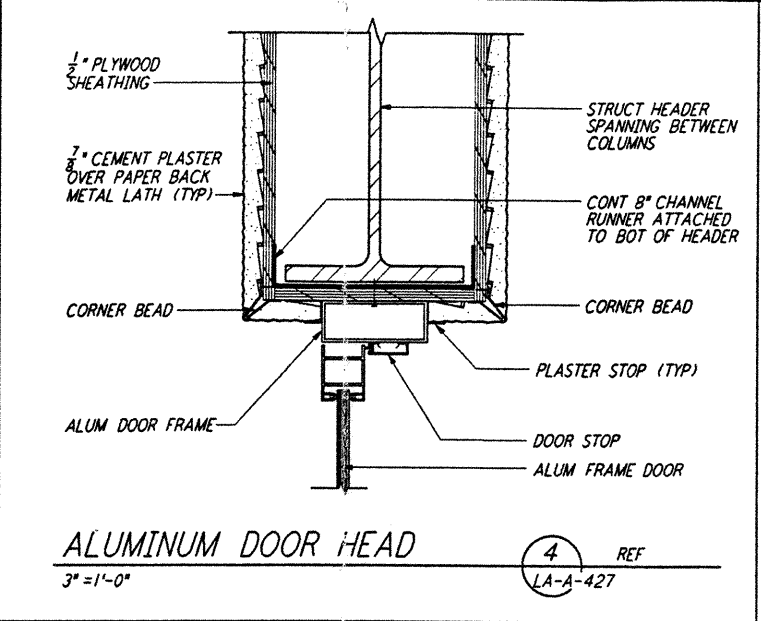
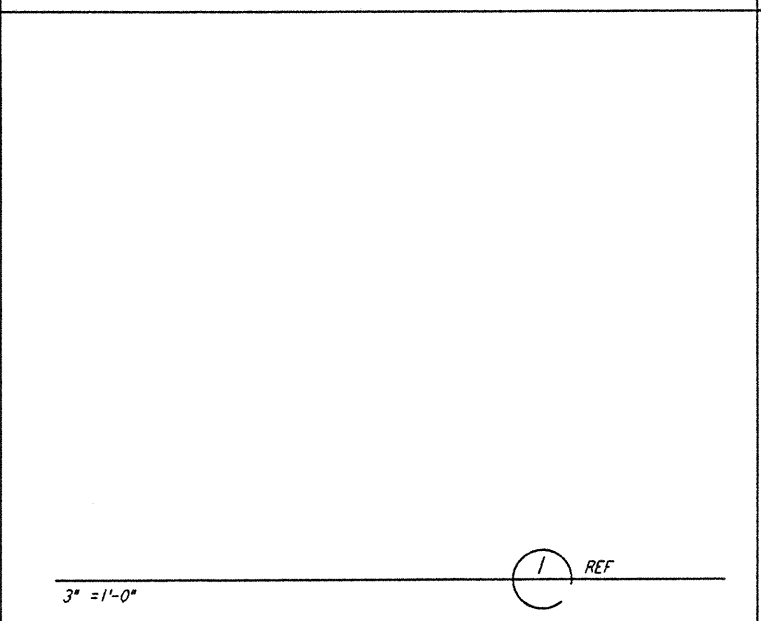
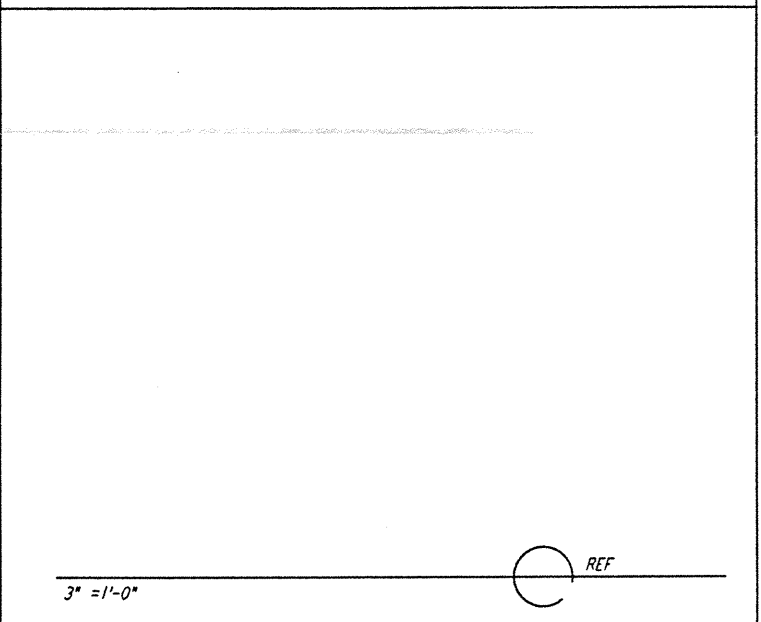
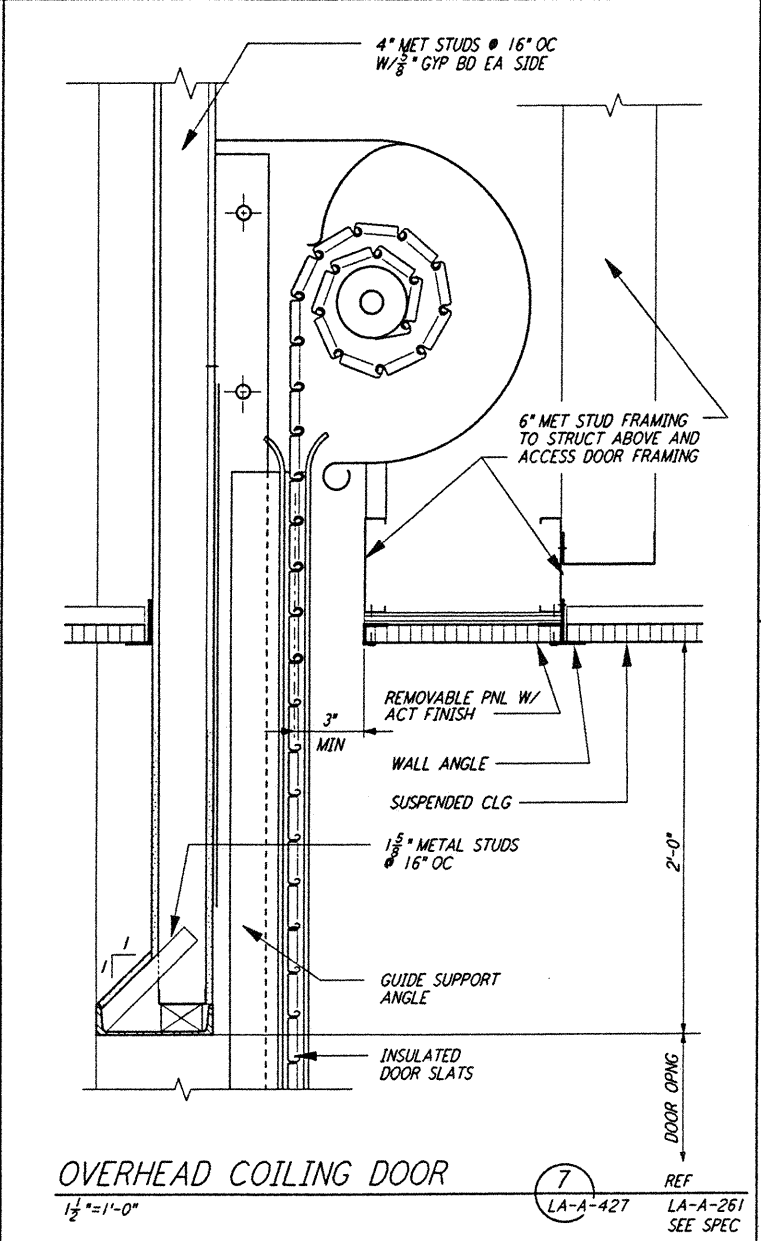
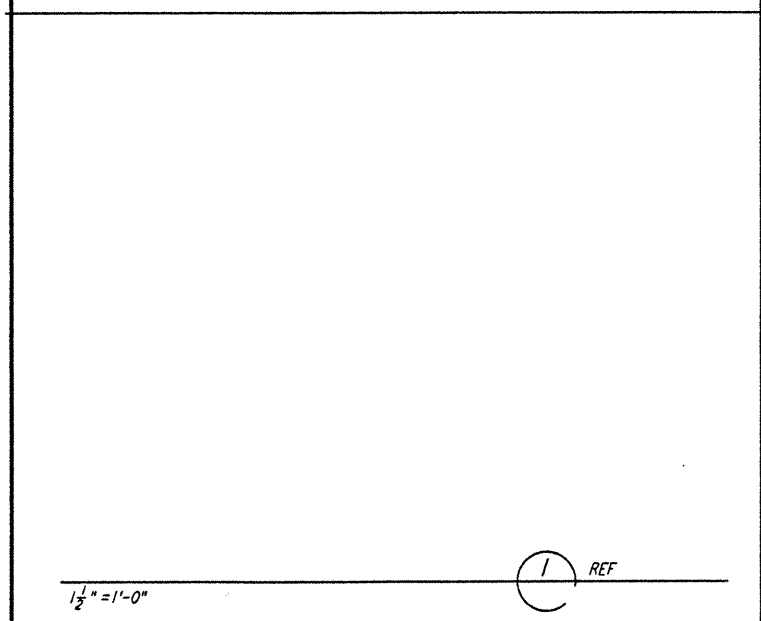
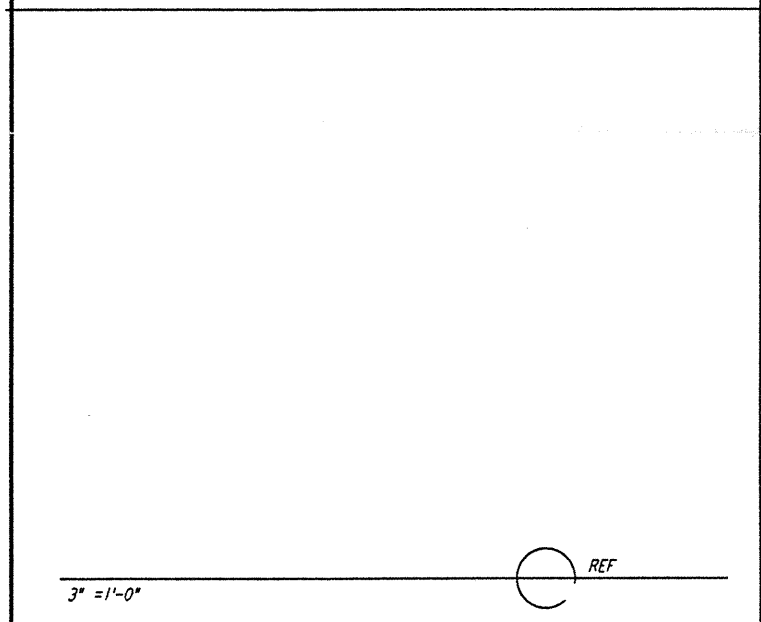
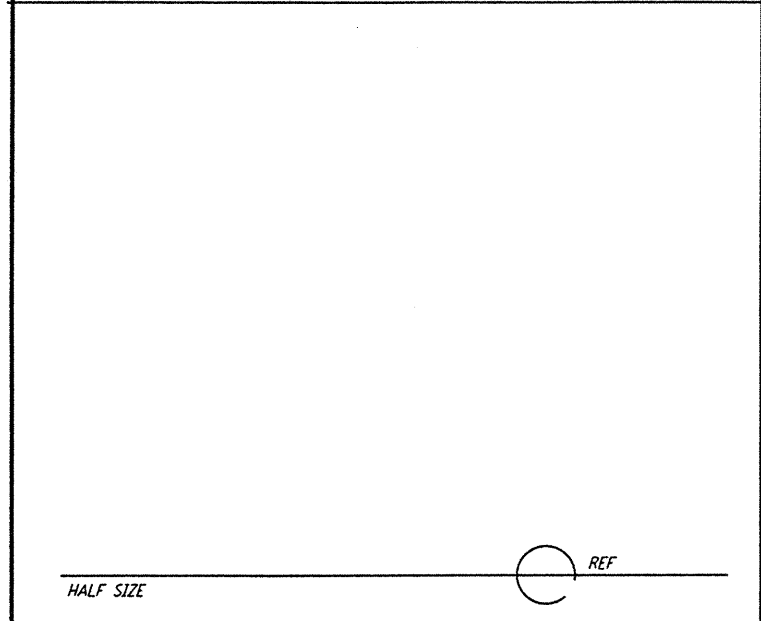
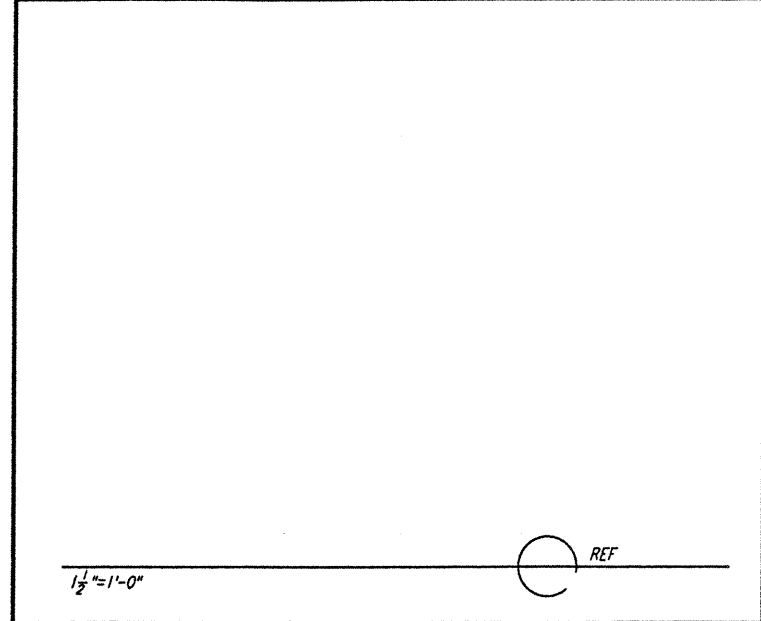

NO.	DATE	BY	CHKD	ENGR	PROJ	DESCRIPTION
B	6-14-96	CKT	BK	SF	TDM	FINAL DESIGN REVIEW
A	10/31/95	SF	SF	TDM		PRELIMINARY DESIGN REVIEW

DRAWN	CKT
CHECKED	
ENGINEER	
PROJ	

**PARSONS**  
 100 WEST WALNUT STREET  
 PASADENA, CALIFORNIA

**LIGO**  
 CALIFORNIA INSTITUTE OF TECHNOLOGY  
 MASSACHUSETTS INSTITUTE OF TECHNOLOGY

LASER INTERFEROMETER  
 GRAVITATIONAL-WAVE OBSERVATORY  
 SITE NO. 2 - LIVINGSTON, LOUISIANA

TITLE: ARCHITECTURAL INTERIOR ELEVATIONS & MISCELLANEOUS DETAILS  
 SHEET NUMBER: LA-A-427  
 PROJECT NUMBER: PPI50969  
 DRAWING NUMBER: 8094