

This document and the design it covers are the property of PARSONS. They are loaned only with the borrower's expressed written agreement that they will not be reproduced, copied, loaned, exhibited, or used in any other way, except by written consent from PARSONS to the borrower.

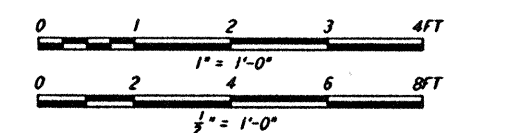
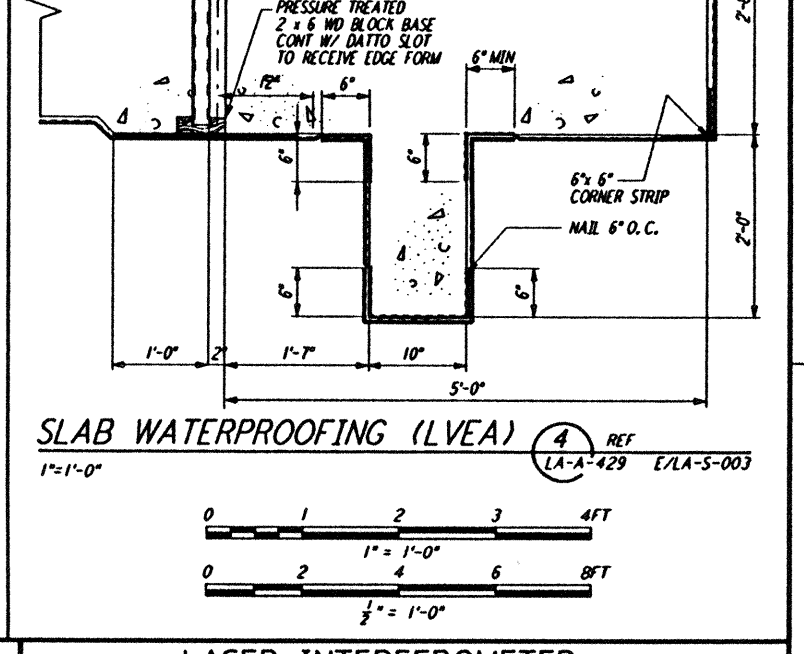
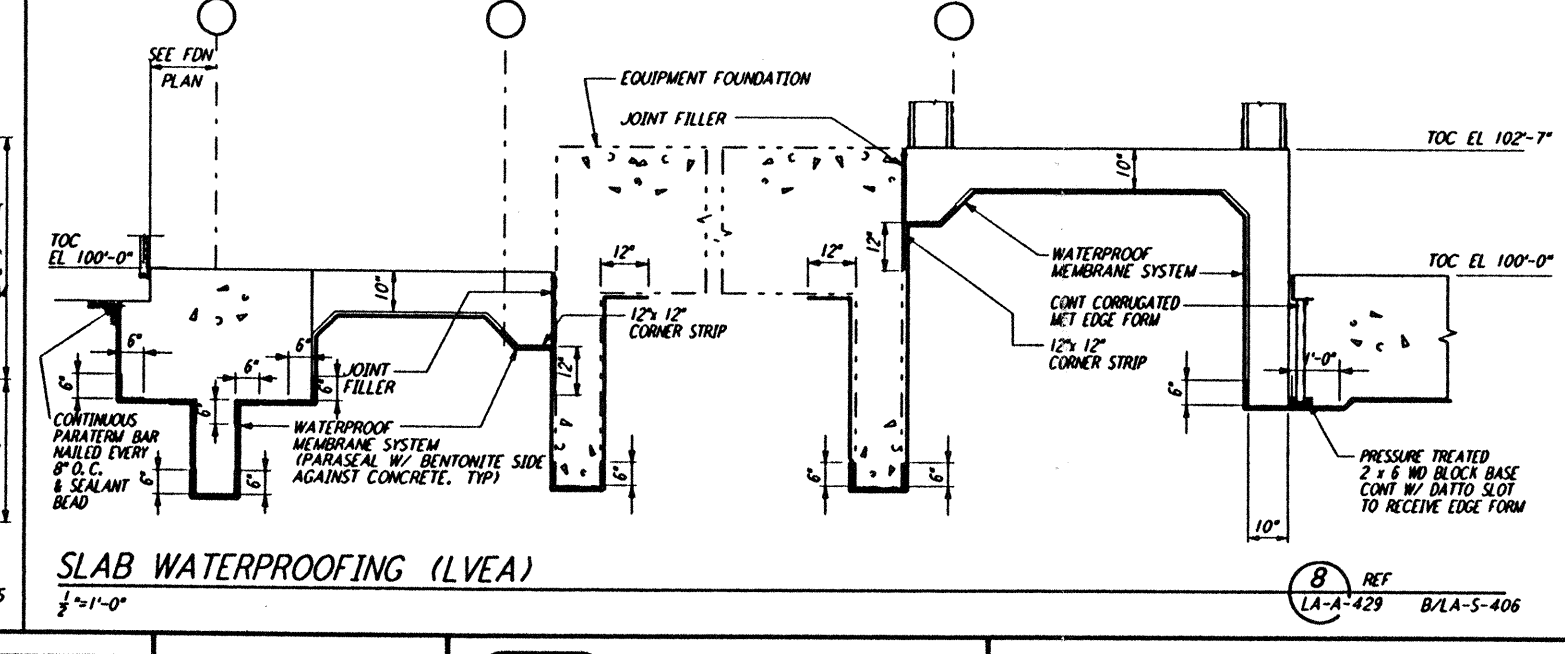
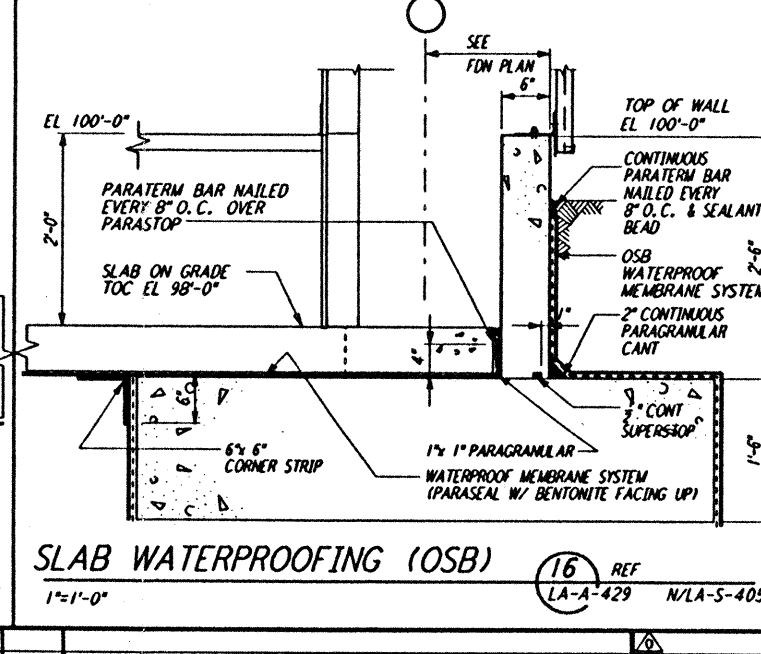
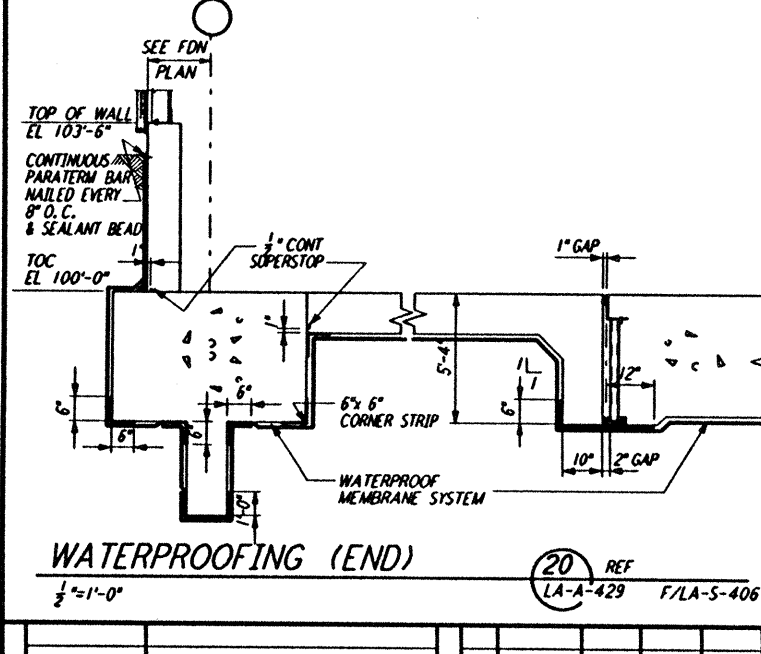
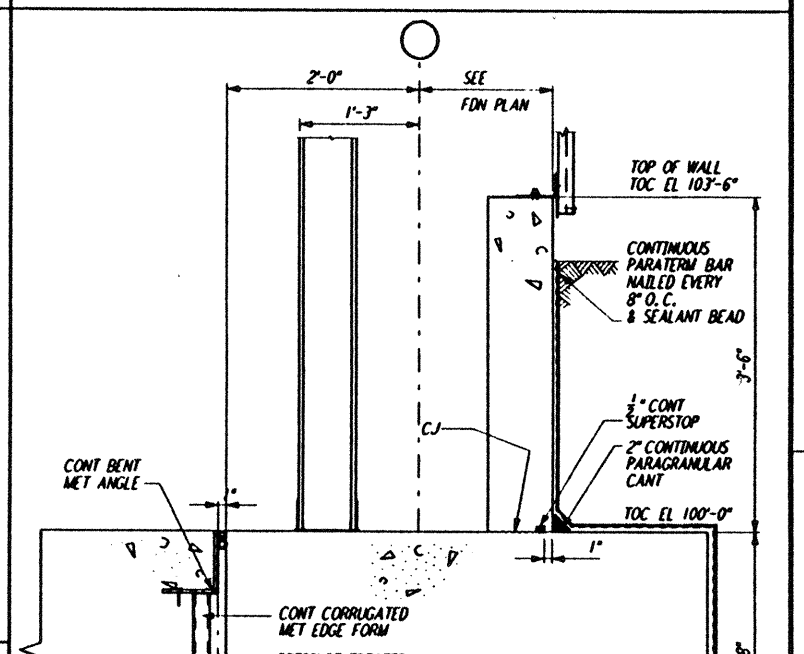
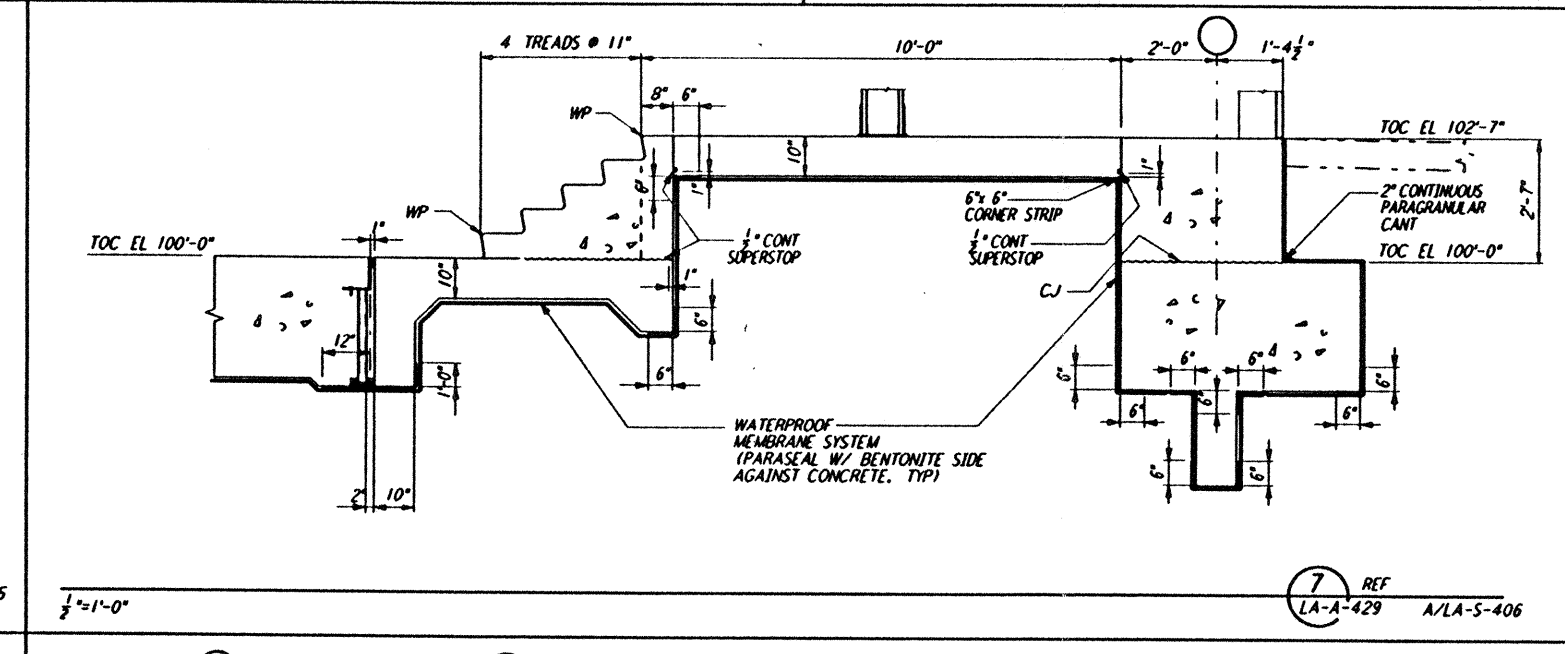
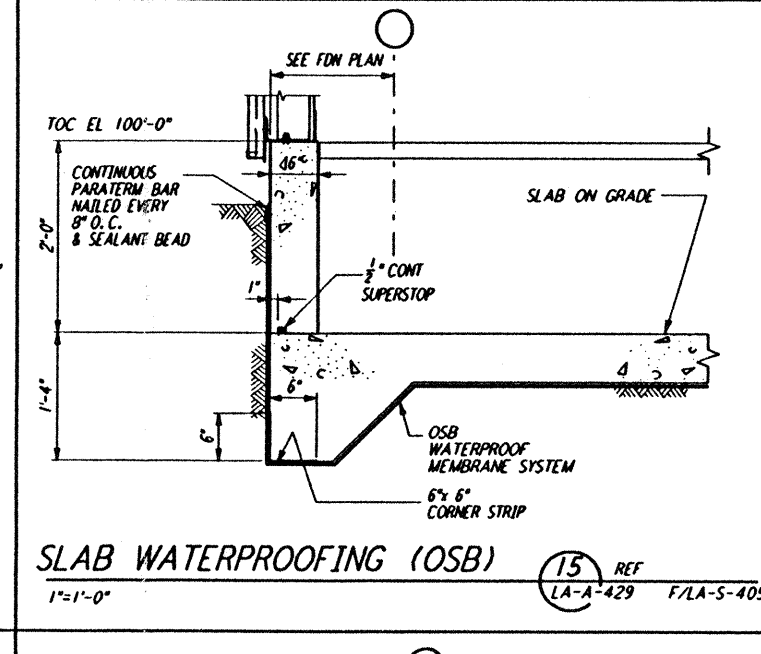
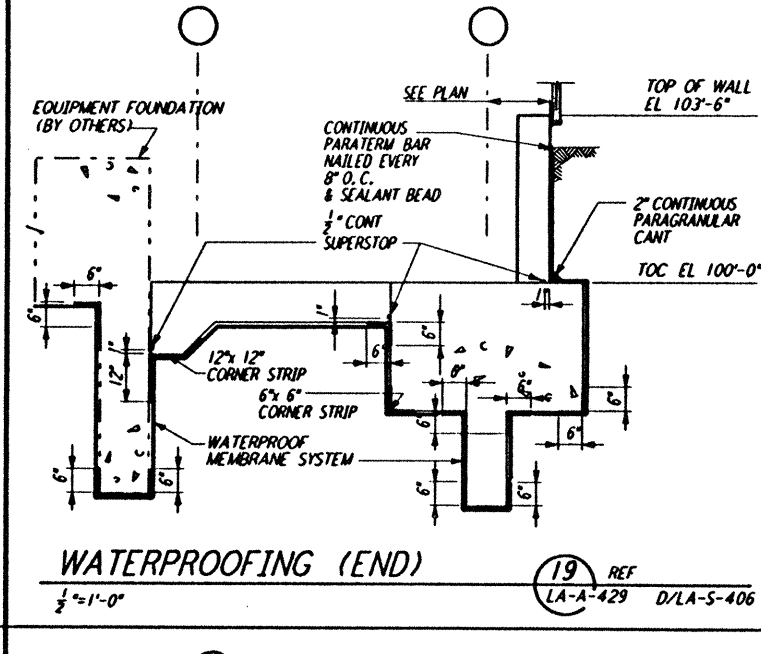
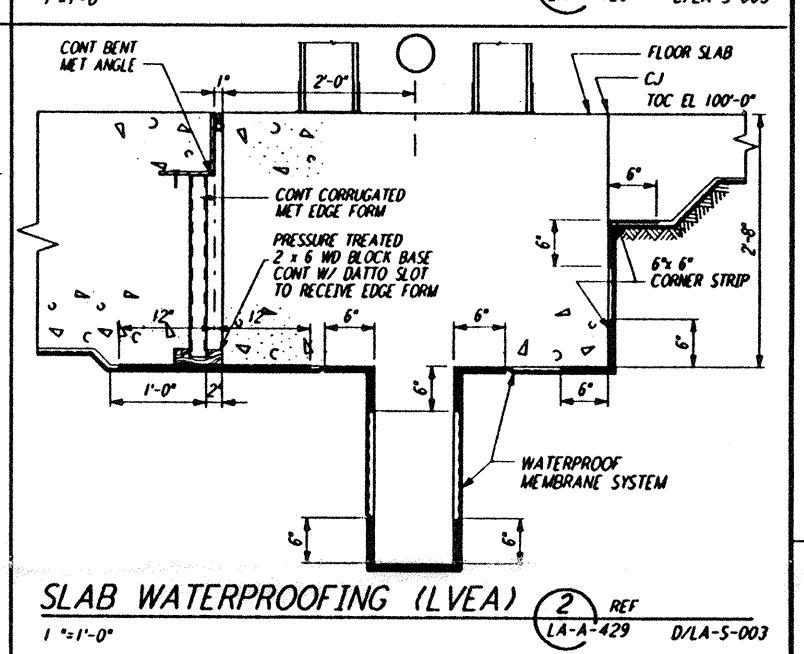
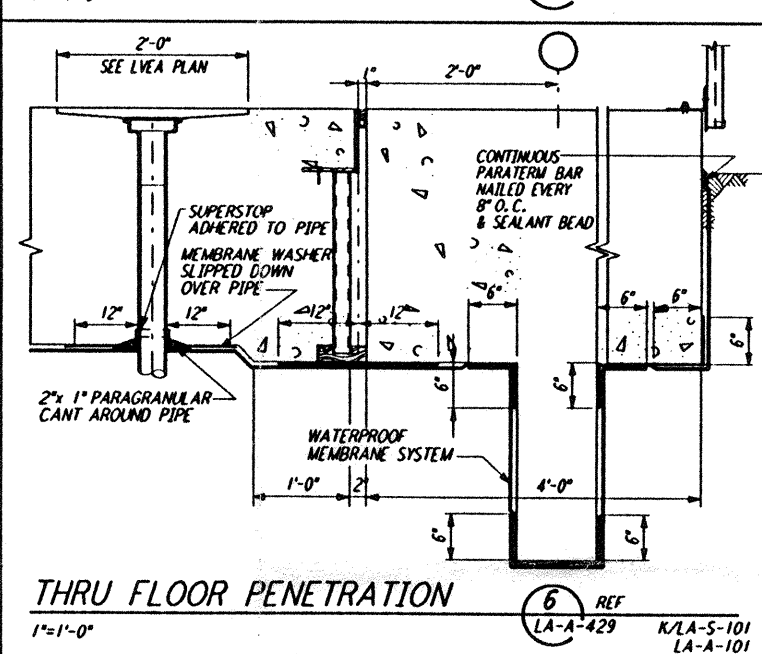
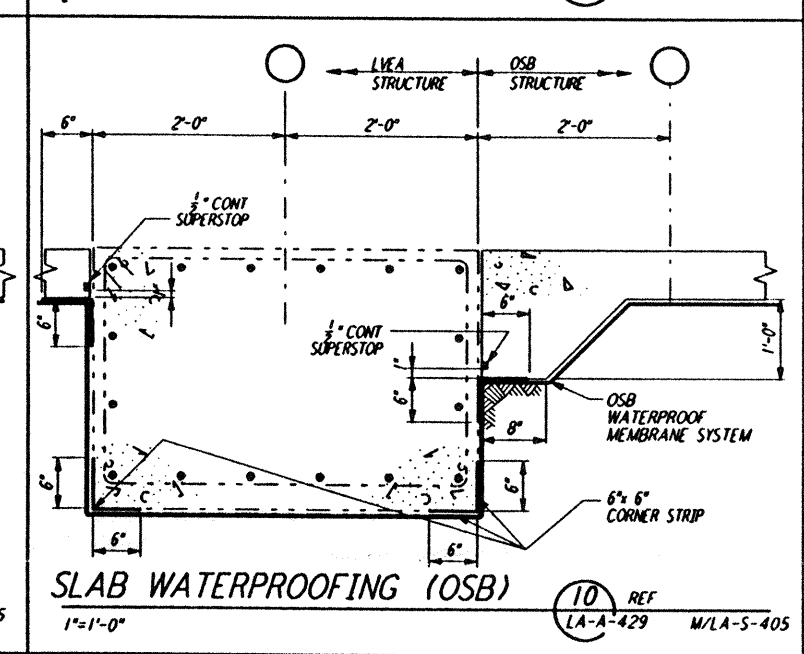
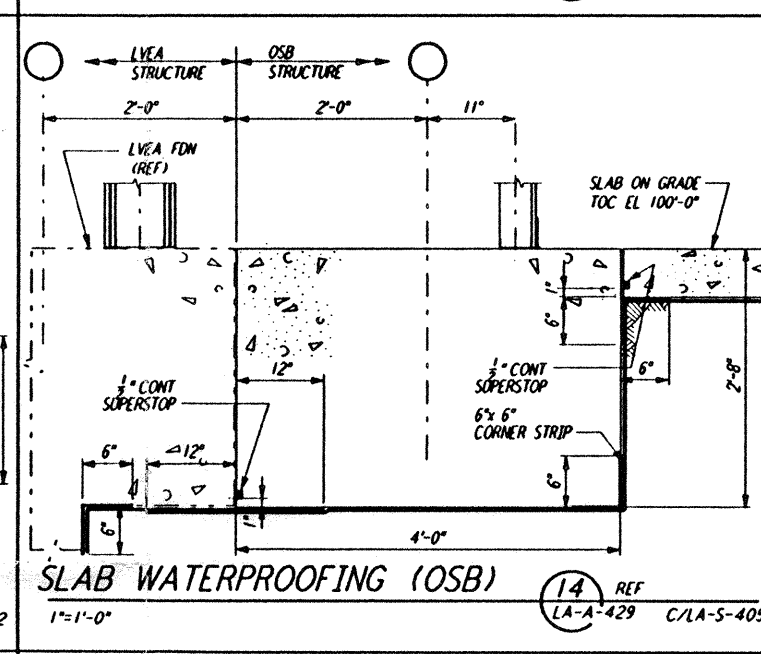
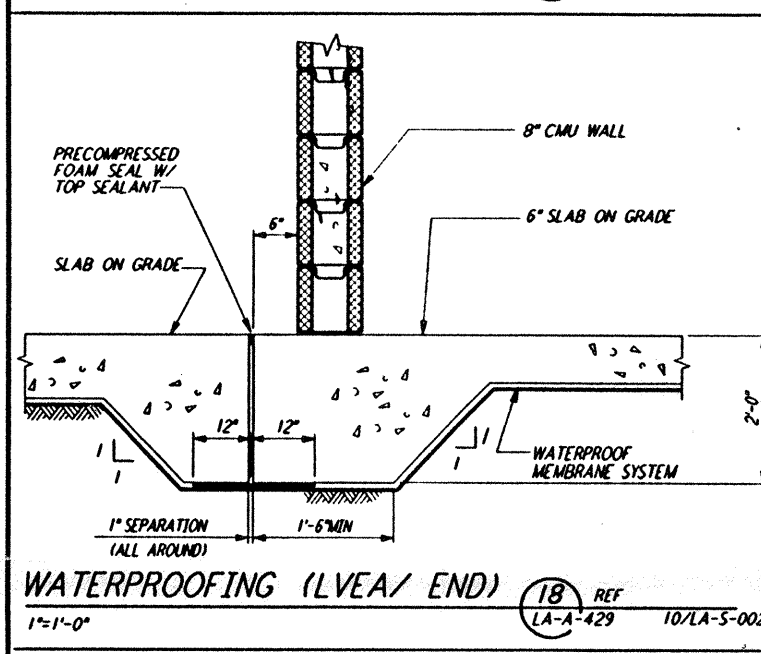
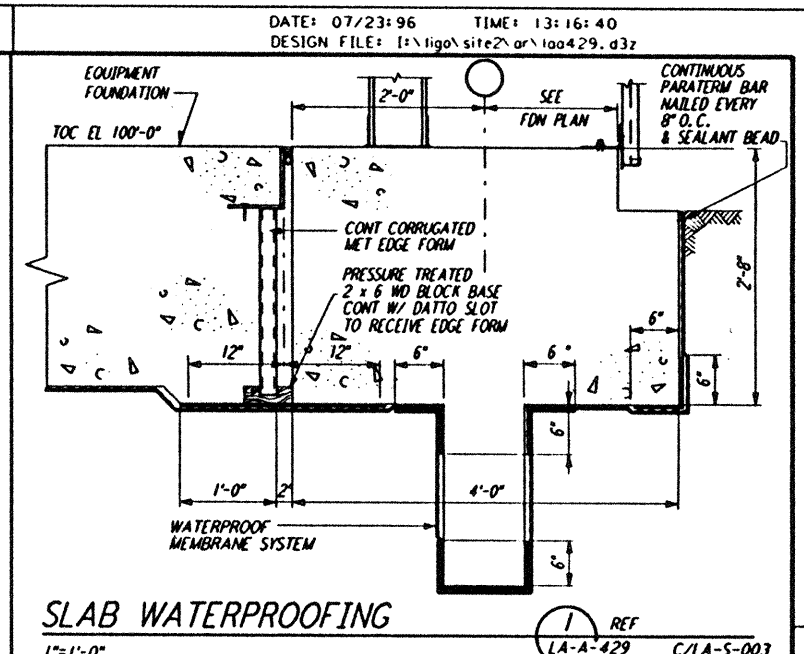
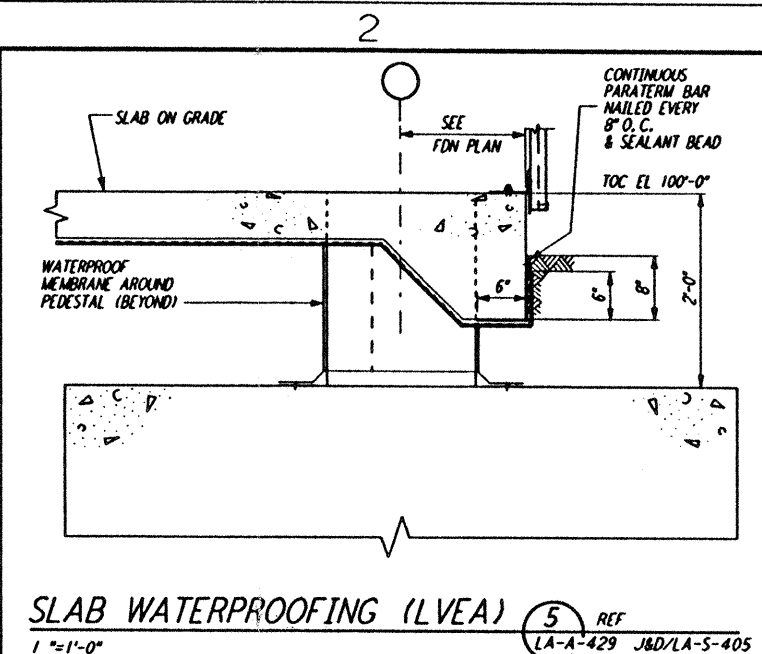
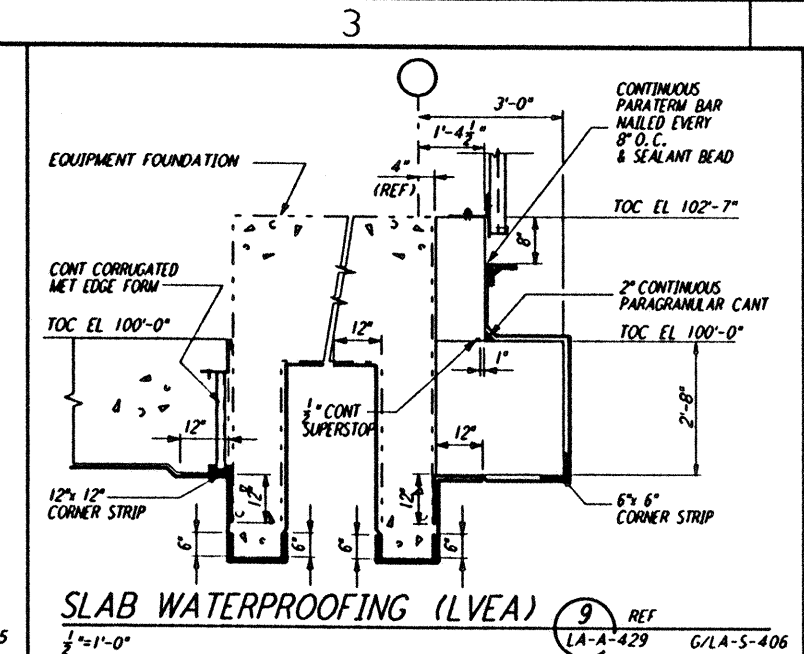
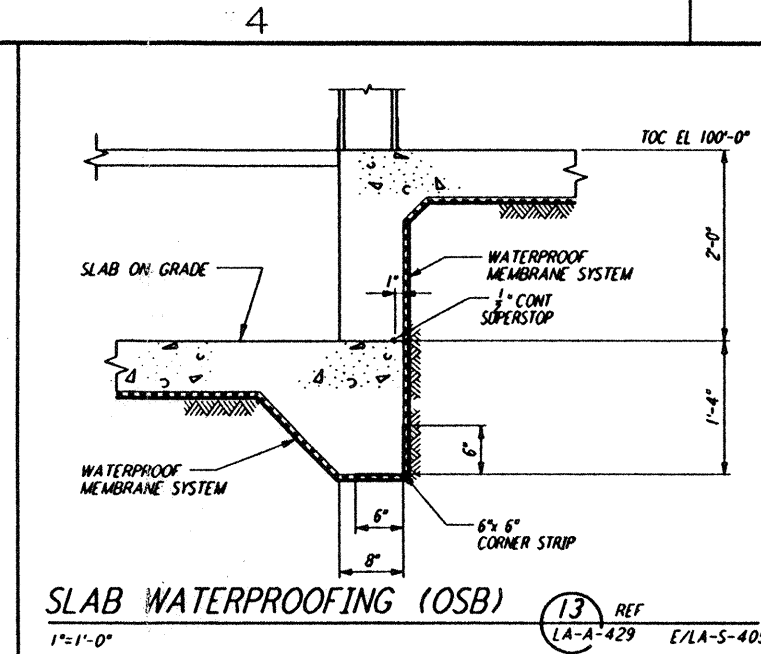
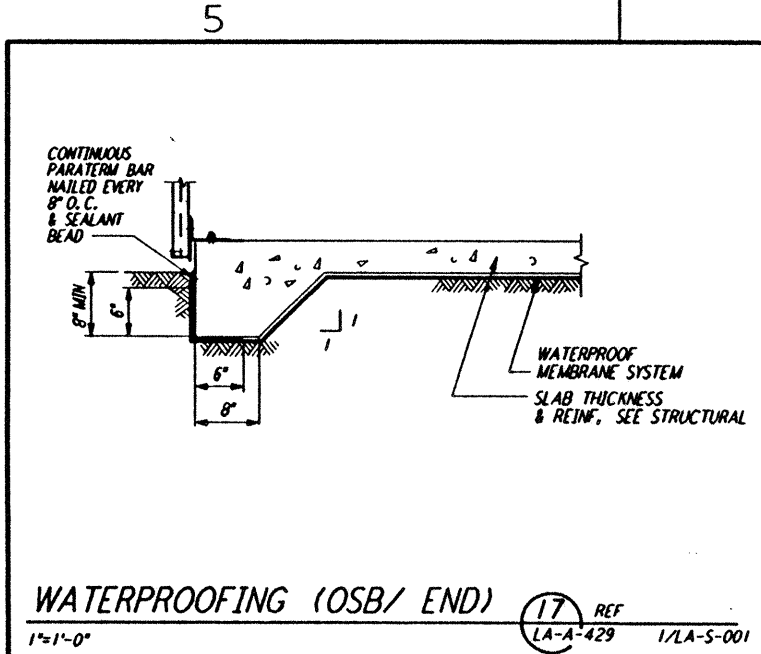

NO.	DATE	BY	CHKD	ENGR	PROJ	DESCRIPTION
B	7-24-96	CKT	TB	BK	TDH	ISSUED FOR BID
A	6-14-96	CKT	BK	SF	TDH	FINAL DESIGN REVIEW

NO.	DATE	BY	CHKD	ENGR	PROJ	DESCRIPTION
B	7-24-96	CKT	TB	BK	TDH	ISSUED FOR BID
A	6-14-96	CKT	BK	SF	TDH	FINAL DESIGN REVIEW

NO.	DATE	BY	CHKD	ENGR	PROJ	DESCRIPTION
B	7-24-96	CKT	TB	BK	TDH	ISSUED FOR BID
A	6-14-96	CKT	BK	SF	TDH	FINAL DESIGN REVIEW

PARSONS
 100 WEST WALNUT STREET
 PASADENA, CALIFORNIA

LIGO
 CALIFORNIA INSTITUTE OF TECHNOLOGY
 MASSACHUSETTS INSTITUTE OF TECHNOLOGY

LASER INTERFEROMETER
 GRAVITATIONAL-WAVE OBSERVATORY
 SITE NO. 2 - LIVINGSTON, LOUISIANA

ARCHITECTURAL
 SLAB WATERPROOFING
 SYSTEM

CONTRACT NUMBER: PP150969
 PROJECT NUMBER: 8094

LA-A-429