

LASER INTERFEROMETER GRAVITATIONAL WAVE OBSERVATORY  
- LIGO -  
CALIFORNIA INSTITUTE OF TECHNOLOGY  
MASSACHUSETTS INSTITUTE OF TECHNOLOGY

<b>Specification</b>	<b>LIGO-E970123-00 - E</b>	08-04-97
<b>LIGO SUSPENSION SYSTEM RELIABILITY PREDICTION REPORT</b>		
LIGO Systems Engineering		

**DRAFT**

This is an internal working note  
of the LIGO Project.

**California Institute of Technology**  
**LIGO Project - MS 18-34**  
**Pasadena CA 91125**  
Phone (626) 395-2129  
Fax (626) 304-9834  
E-mail: [info@ligo.caltech.edu](mailto:info@ligo.caltech.edu)

**Massachusetts Institute of Technology**  
**LIGO Project - MS 20B-145**  
**Cambridge, MA 01239**  
Phone (617) 253-4824  
Fax (617) 253-7014  
E-mail: [info@ligo.mit.edu](mailto:info@ligo.mit.edu)

WWW: <http://www.ligo.caltech.edu/>

**DRAFT**

EXECUTIVE SUMMARY	3
1.0 INTRODUCTION	4
2.0 ACRONYMS	5
3.0 APPLICABLE DOCUMENTS	6
4.0 RELIABILITY REQUIREMENTS	7
5.0 RELIABILITY ANALYSES	8
5.1 RELIABILITY MODELING	8
5.2 RELIABILITY AND AVAILABILITY ALLOCATIONS	15
5.3 RELIABILITY PREDICTIONS	16
5.4 AVAILABILITY PREDICTIONS	18
5.5 40 M MODEL TEST DATA	19
6.0 CONCLUSIONS	19
Appendix A: SUS Subassembly Reliability Prediction	A-20
Appendix B: SUS Preamplifier Reliability Prediction	B-27
Appendix C: SUS Controller Reliability Prediction	C-29
Appendix D: HIF1 SUS Availability Prediction	D-38
Appendix E: HIF2 SUS Availability Prediction	E-46
Appendix F: LIGO 3X: SUS Availability Prediction	F-54
Appendix G: LIGO 2X: SUS Availability Prediction	G-56
Appendix H: LIGO 1X: SUS Availability Prediction	H-58

DRAFT

**EXECUTIVE SUMMARY**

Based upon the available design information, the SUS Availability predictions indicate that the SUS will meet, or exceed, the Availability necessary to achieve the top level LIGO Availability requirements.

<i>Mode of Operation</i>	<i>Allocated Annual Availability</i>	<i>Predicted Annual Availability</i>
3X	0.9839	0.9871
2X	0.9946	0.9959
1X	1.0000	1.0000

**DRAFT**

## 1.0 INTRODUCTION

Various suspension components are integrated into the Core Optics Component (COC) and into the Input/Output Optic (IOO) systems. For purposes of this report, the COC and the IOO suspension components, in addition to the suspension components for the other suspended components, are combined into what is defined as the Suspension (SUS) System.

Reliability, repair time and availability calculations were performed on the SUS System of the Laser Interferometer Gravitational Wave Observatory (LIGO). Failure rate data was obtained from the following sources:

- “Non-Electronic Parts Reliability Data 1995,” NPRD-95, Reliability Analysis Center.
- “Reliability Prediction Of Electronic Equipment,” MIL-HDBK-217F, December 1991.
- Engineering estimates predicated upon experience with equipments of similar complexity.

The calculations were predicated upon the design information available at the time this report was prepared. This report will be periodically updated to reflect the current design at that time.

**DRAFT**

## 2.0 ACRONYMS

A	Operational Availability
ASSY	Assembly
BS	Beam Splitter
ETM	End Test Mass
FI	Faraday Isolator
FM	Fold Mirror
FPMH	Failures Per Million Hours
FTA	Fault Tree Analysis
HIF1	Interferometer, 4 km long, at Hanford, Washington site
HIF2	Interferometer, 2 km long, at Hanford, Washington site
ITM	Input Test Mass
LED	Light Emitting Diode
LIF1	Interferometer, 4 km long, at Livingston, Louisiana site
LBSC	Beam Splitter Chamber at Livingston, Louisiana site
LHAM	Horizontal Access Module at Livingston, Louisiana site
LIGO	Laser Interferometer Gravitational Wave Observatory
LOS1	Large Optics Suspension 1 Subsystem
LOS2	Large Optics Suspension 2 Subsystem
MC	Mode Cleaner
MDT	Mean Down Time
MMT	Mode Matching Telescope
MTBF	Mean Time Between Failure ( $\lambda^{-1}$ )
N/A	Not Applicable
Q	Operational Unavailability
RM	Recycling Mirror
SA	Suspension Assembly
SOS	Small Optics Suspension Subsystem
SUS	Suspension System
WBSC	Beam Splitter Chamber at Hanford, Washington site
WHAM	Horizontal Access Module at Hanford, Washington site
$\lambda$	Failure Rate

DRAFT

### 3.0 APPLICABLE DOCUMENTS

The documents containing Suspension System Design Requirements, LIGO reliability requirements and guidelines, reliability modeling and prediction methods, and the software used to perform the reliability predictions and availability calculations are listed in the tables below.

TABLE 3-1. Project Documents

LIGO-E960099-A-E	LIGO Reliability Program Plan
LIGO-T950011-14-D	Suspension Design Requirements
LIGO-T960074-07-D	Suspension Preliminary Design
LIGO - E950018-02-E	LIGO Science Requirements Document
LIGO-E950084, dated 10/27/94	LIGO System Specification

TABLE 3-2. Basic Reliability Standards and Handbooks

MIL-STD-785	Reliability Program for Systems and Equipment Development and Prediction
MIL-STD-756	Reliability Modeling and Prediction
MIL-HDBK-217F	Reliability Prediction For Electronic Equipment
NRPD-95	Non-Electronic Parts Reliability Data 1995, Reliability Analysis Center

TABLE 3-3. Reliability Software

RELEX 217	Reliability prediction software used in calculating failure rates for hardware items.
ITEM Software FaultTree+	Fault tree analysis software used in performing Availability calculations

**DRAFT**

#### 4.0 RELIABILITY REQUIREMENTS

The LIGO top level system availability requirements are summarized in Table 4-1 below:

TABLE 4-1: LIGO System Reliability Requirements

<i>Mode of Operation</i>	<i>Annual Availability</i>	<i>Minimum Continuous Operating Period</i>
1X	0.90%	40 hours
2X	0.85%	100 hours
3X	0.75%	100 hours

The Modes of Operation are defined as:

- a. Single Operations Mode (1X): At least one of the three interferometers is operational.
- b. Double Operations Mode (2X): At least two interferometers are operational. One of which must be the Louisiana interferometer.
- c. Triple Operations Mode (3X): All three interferometers are operational.

SUS Reliability and Availability requirements are not specified in the Suspension Preliminary Design Document or in the Suspension Design Requirements Document.

**DRAFT**

## 5.0 RELIABILITY ANALYSES

SUS reliability was assessed by means of :

- Reliability Modeling
- Reliability and Availability Allocations
- Reliability and Availability Predictions
- Fault Tree Analysis

### 5.1 RELIABILITY MODELING

The SUS Reliability Block Diagram for the LIGO 3X Operating Mode is shown in Figure 1. The Reliability Block Diagram depicts a series model in which it is necessary for the SUS at each of the three Interferometers, the Washington 4km Interferometer SUS (HIF1 SUS), the Washington 2km Interferometer SUS (HIF2 SUS) and the Louisiana 4km Interferometer SUS (LIF1 SUS), to be operational for successful LIGO 3X operation.

The SUS Reliability Model for the LIGO 2X Operating Mode is shown in Figure 2. The combination series/parallel model illustrates that at least the HIF1 SUS or the HIF2 SUS must be operational along with the LIF1 SUS for successful LIGO 2X operation.

The SUS Reliability Model for the LIGO 1X Operating Mode is shown in Figure 3. This parallel model depicts that only one of the three SUS systems (HIF1 SUS, HIF2 SUS or LIF1 SUS) is required to be operational for successful LIGO 1X operation.

The SUS for each Interferometer consists of three different types of Suspension Assemblies. The size of the suspended optic determines which type of Suspension Assembly is used. There are two types of Large Optics Suspension Assemblies (LOS1, LOS2) and one type of Small Optics Suspension Assemblies (SOS). All three types of Suspension Assemblies are similar with the exception of size.

The HIF1 SUS and the LIF1 SUS each contain thirteen Suspension Assemblies. The HIF2 SUS contains sixteen Suspension Assemblies. The HIF2 SUS has two additional LOS1 Assemblies and one additional SOS Assembly. The three additional HIF2 Suspension Assemblies are required to suspend three additional Fold Mirrors. Figure 4 shows the Reliability Model for the HIF2 SUS. The model shows that there are eight LOS1 Suspension Assemblies, one LOS2 Suspension Assembly, and seven SOS Suspension Assemblies. Each of the 16 Suspension Assemblies must be operational in order for successful operation of the HIF2 SUS. The Reliability Models for the HIF1 SUS and the LIF1 SUS would be the same as Figure 4 except that there would be six LOS1 Suspension Assemblies, one LOS2 Suspension Assembly, and six SOS Suspension Assemblies. Table 5-1 identifies the suspended optic, its respective Suspension Assembly, and its location within the Interferometer.

Figure 5 shows the Reliability Block Diagram for an individual Suspension Assembly. The size differences between the LOS1, LOS2 and SOS Suspension Assemblies do not impact the results of the reliability modeling and/or predictions. Therefore, for the purposes of this report, the three different types of Suspension Assemblies are considered equivalent.



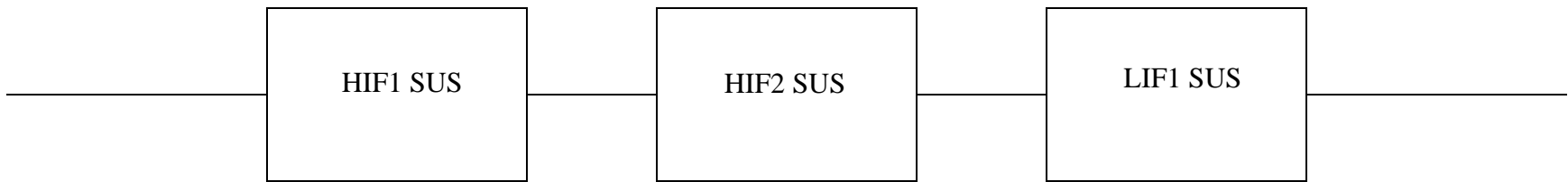

DRAFT

**FIGURE 1. SUS Reliability Block Diagram For The LIGO 3X Operating Mode**

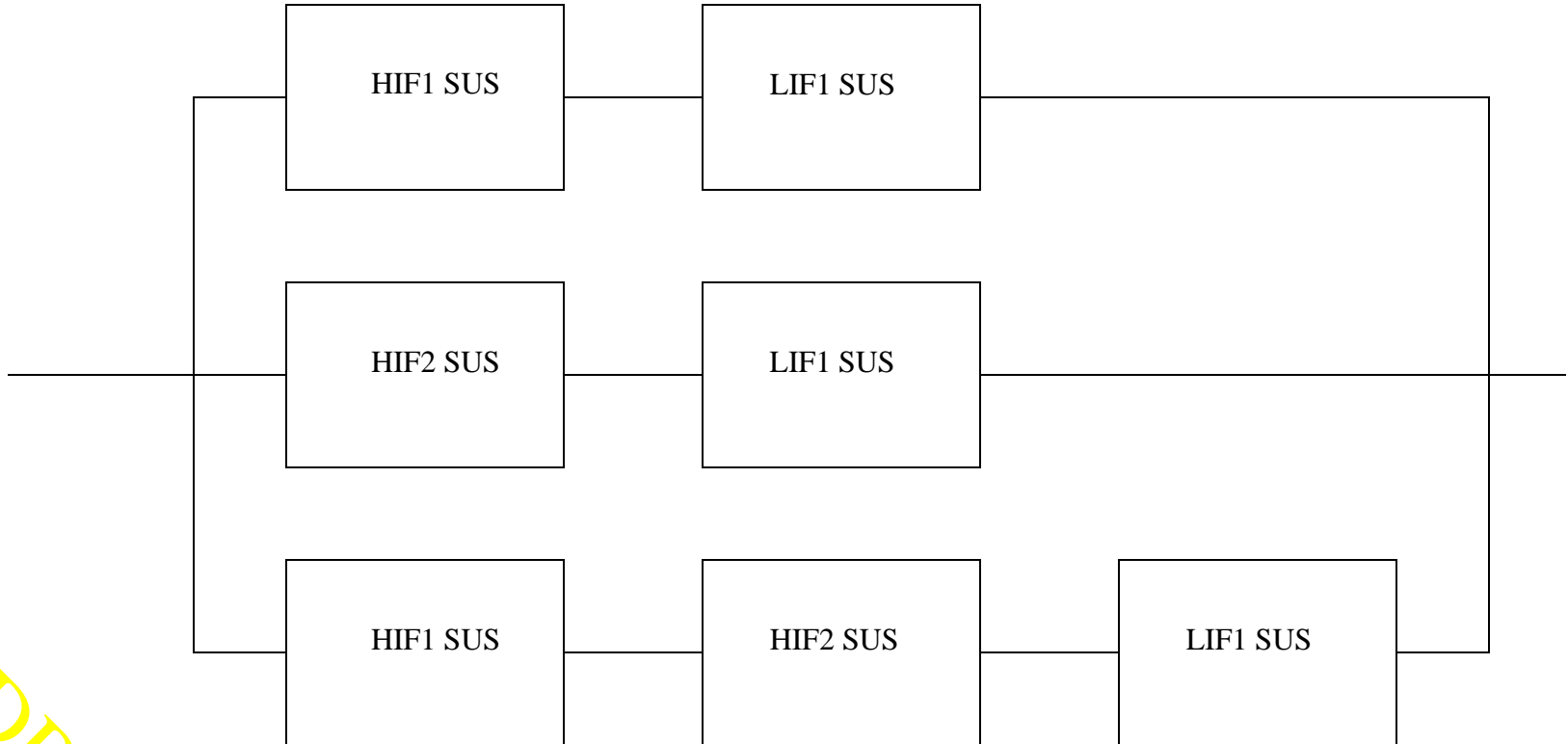

DRAFT

**FIGURE 2. SUS Reliability Block Diagram For The LIGO 2X Operating Mode**

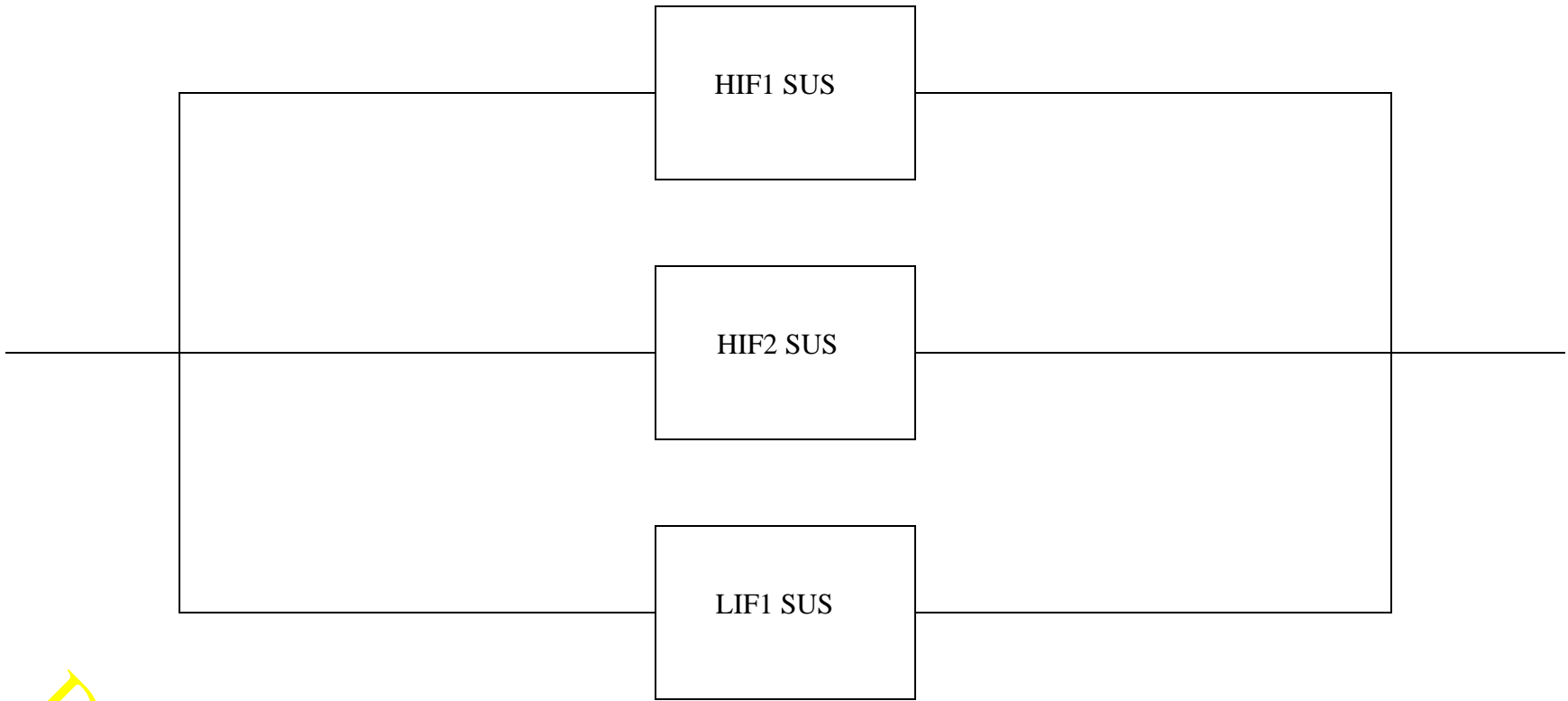

DRAFT

**FIGURE 3. SUS Reliability Block Diagram For The LIGO 1X Operating Mode**

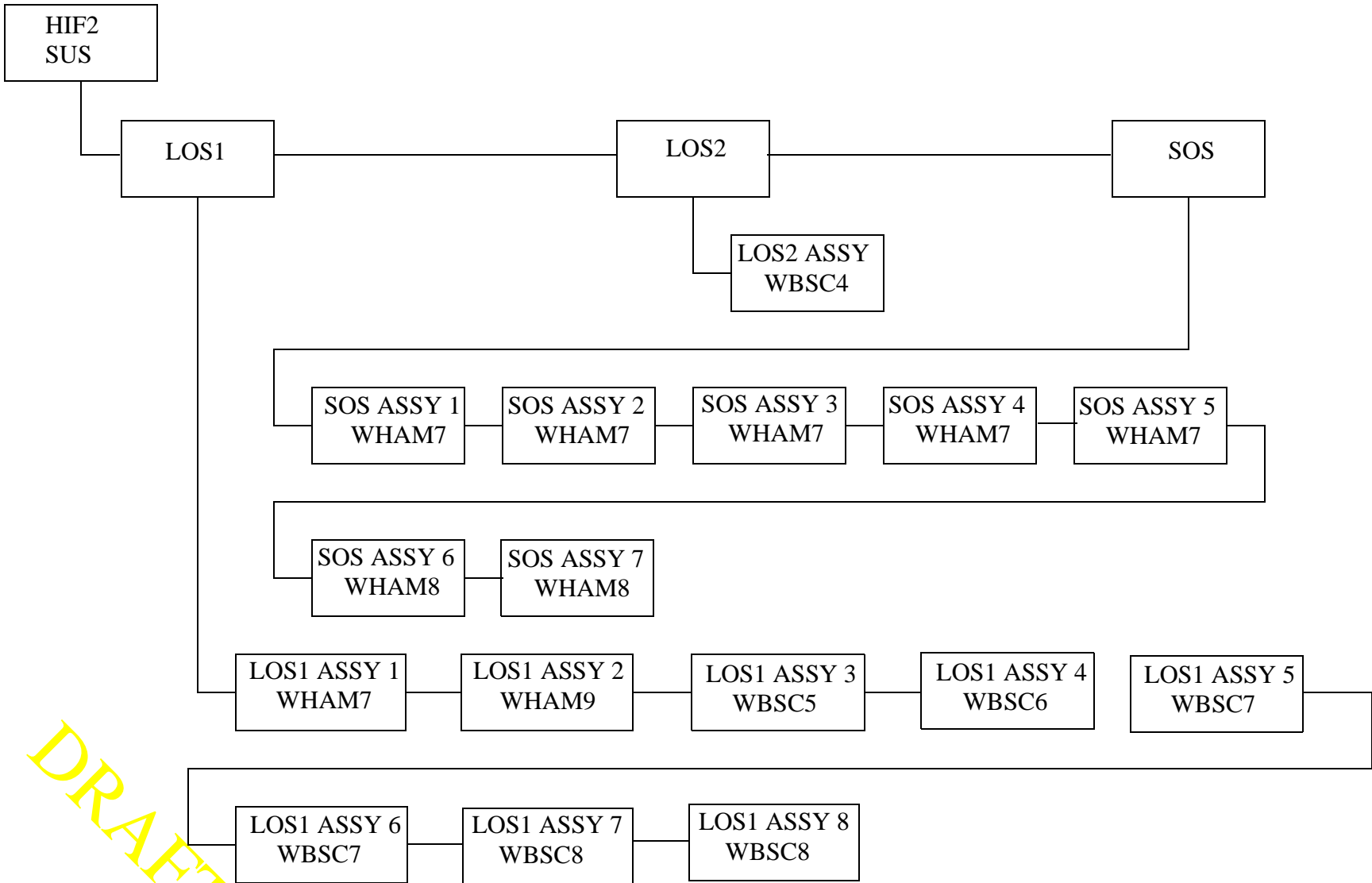

DRAFT

FIGURE 4. HIF2 Reliability Block Diagram

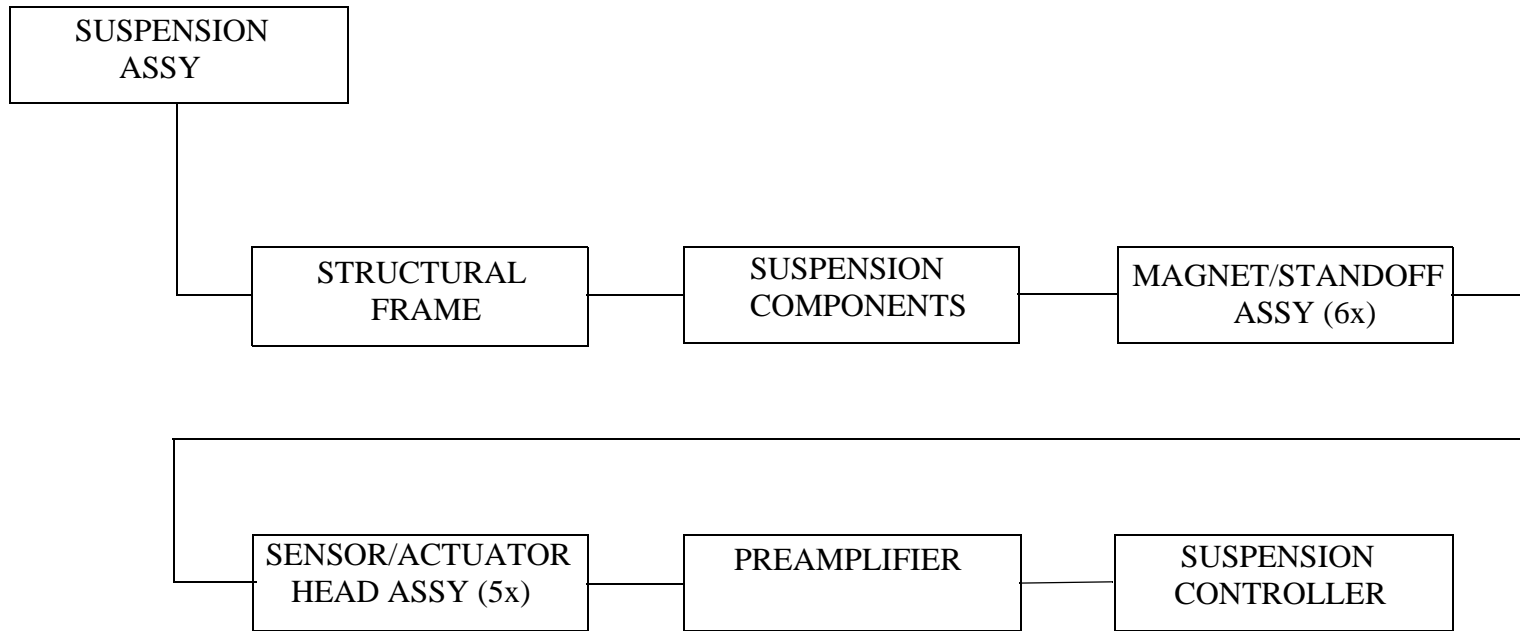

DRAFT

**FIGURE 5. Suspension Assembly Reliability Block Diagram**

TABLE 5-1: Optics / Suspension Assembly Locations

<i>OPTIC</i>	<i>SUSPENSION ASSEMBLY</i>			<i>LOCATION</i>		
	<i>LOS1</i>	<i>LOS2</i>	<i>SOS</i>	<i>HIF1</i>	<i>HIF2</i>	<i>LIF1</i>
ITM <sub>X</sub>	X			WBSC3	WBSC7	LBSC3
ITM <sub>Y</sub>	X			WBSC1	WBSC8	LBSC1
ETM <sub>X</sub>	X			WBSC9	WBSC5	LBSC4
ETM <sub>Y</sub>	X			WBSC10	WBSC6	LBSC5
RM	X			WHAM3	WHAM9	LHAM3
BS		X		WBSC2	WBSC4	LBSC2
MMT3	X			WHAM1	WHAM7	LHAM1
MMT2			X	WHAM2	WHAM8	LHAM2
MMT1			X	WHAM1	WHAM7	LHAM1
MC3			X	WHAM1	WHAM8	LHAM1
MC2			X	WHAM1	WHAM7	LHAM2
MC1			X	WHAM1	WHAM7	LHAM1
FM1			X	WHAM1	WHAM7	LHAM1
FM2			X	N/A	WHAM7	N/A
FM <sub>X</sub>	X			N/A	WBSC7	N/A
FM <sub>Y</sub>	X			N/A	WBSC8	N/A

DRAFT

## 5.2 RELIABILITY AND AVAILABILITY ALLOCATIONS

Reliability and Availability requirements were not specified to the subsystem level in the SRD. Preliminary allocations were performed for the LIGO 3X Mode of Operation which, from a reliability perspective, was determined to be the worst case operating scenario. For allocation purposes, the SUS at each of the Interferometers was assumed to be the same. Each Interferometer requires the SUS to be operational.

The preliminary allocations for the SUS in each Interferometer of the LIGO 3X Operating Mode are:

- Failure Rate ( $\lambda_{SUS}$ ): 76.00 Failures Per Million Hours (FPMH)
- Mean-Time-Between-Failure (MTBF): 13, 158 Hours
- Mean-Down-Time (MDT): 72.0 Hours
- Availability ( $A_{SUS}$ ): 0.9946

MDT is the total preventive and corrective maintenance time divided by the number of preventive and corrective maintenance actions for the SUS. Logistic delays are included in the calculation of the preventive and corrective maintenance times. The allocated MDT allows for the possibility of a bake-out being required following SUS maintenance actions. The allocated MDT also assumes that the number of on-site spares and any on-site maintenance support contracts will support a 72.0 hour MDT.

Availability is defined as the ability of an item, under the combined aspects of its reliability and maintenance, to perform its required function over a given period of time. Therefore, Availability allows for trade-offs between reliability and maintenance. Mathematically, Availability is approximated as:

$$A = \frac{MTBF}{MTBF + MDT}$$

The three types of Suspension Assemblies are similar, with the exception of size. Therefore, their individual failure rates were considered equal;  $\lambda_{SA} = \lambda_{LOS1 SA} = \lambda_{LOS2 SA} = \lambda_{SOS SA}$ . The HIF2 SUS contains the largest number of Suspension Assemblies, 16. Therefore, the HIF2 SUS was selected as the baseline for the reliability allocations. As a result,

$$\frac{76.00 FPMH}{HIF2SUS} \times \frac{HIF2SUS}{16SA_s} = \frac{4.75 FPMH}{SA}$$

DRAFT

Therefore, the preliminary allocation for each SUS Assembly is:

- Failure Rate ( $\lambda_{SA}$ ): 4.75 FPMH
- MTBF: 210,526 Hours
- MDT: 72.0 Hours
- $A_{SA}$ : 0.9997

### 5.3 RELIABILITY PREDICTION

A reliability prediction was performed on the various components of the Suspension Assembly using the RELEX 217 software package. Table 5-2 identifies the failure rate data source for each component of the Suspension Assembly.

Reliability predictions for electronic components were performed using the failure rate models of MIL-HDBK-217 and the Ground Benign operating environment. MIL-HDBK-217F defines the Ground Benign environment as:

“Nonmobile, temperature and humidity controlled environments readily accessible to maintenance; includes laboratory instruments and test equipment, medical electronic equipment, business and scientific computer complexes, and missiles and support equipment in ground silos.”

Reference Figure 5. For purposes of this report, the SUS Subassembly is comprised of the Structural Frame, the Suspension Components, the Magnet/Standoff Assemblies and the Sensor/Actuator Head Assemblies. An ambient temperature of 40°C was used to calculate the failure rate of electronic components within the vacuum environment. Based upon industry standards, a value of 0.001 FPMH was used for structural and mechanical components. The predicted failure rate for the SUS Subassembly,  $\lambda_{sub}$ , is 1.1821 FPMH. The RELEX 217 report, detailing the SUS Subassembly reliability predictions, is provided in Appendix A.

Detailed design information was not available for the SUS Control Electronics of the full scale LIGO. Therefore, failure rate predictions were performed on the SUS Preamplifier and SUS Controller of the 40M Model in order to establish a reliability baseline for the SUS Control Electronics of the full scale LIGO. The SUS Control Electronics is outside the vacuum environment. Therefore, an ambient temperature of 35°C was used to calculate the failure rate for the electronic components of the SUS Control Electronics. The predicted failure rate for the SUS Preamplifier,  $\lambda_{amp}$ , is 9.2409 FPMH. The predicted failure rate for the SUS Controller,  $\lambda_{cntl}$ , is 39.0701 FPMH. The RELEX 217 reports, detailing the SUS Preamplifier and the SUS Controller reliability predictions, are provided in Appendices B and C, respectively.

The predicted failure rate for each Suspension Assembly,  $\lambda_{SA}$ , is:

$$\lambda_{SA} = \lambda_{sub} + \lambda_{amp} + \lambda_{cntl} = 1.1821 + 9.2409 + 39.0701 = 49.4931 \text{ FPMH.}$$

The Suspension Assembly MTBF is 20,205 hours.

DRAFT



TABLE 5-2: Reliability Data Sources

<i>Description</i>	<i>Failure Rate (<math>\lambda</math>) (FPMH)</i>	<i>MTBF (Hours)</i>	<i>Source</i>
Preamplifier	9.2409	108,215	MIL-HDBK-217
Controller	39.0701	25,595	MIL-HDBK-217
Height Adapter	0.0010	1 x 10 <sup>9</sup>	Engineering Estimate
Stiffening Bars	0.0010	1 x 10 <sup>9</sup>	Engineering Estimate
Support Structure	0.0010	1 x 10 <sup>9</sup>	Engineering Estimate
Head Holder	0.0010	1 x 10 <sup>9</sup>	Engineering Estimate
Wire Standoff	0.0010	1 x 10 <sup>9</sup>	Engineering Estimate
Wire Guide Rod	0.0010	1 x 10 <sup>9</sup>	Engineering Estimate
Suspension Block	0.0010	1 x 10 <sup>9</sup>	Engineering Estimate
Crescent Wire Guide	0.0010	1 x 10 <sup>9</sup>	Engineering Estimate
Suspension Wire	0.0010	1 x 10 <sup>9</sup>	Engineering Estimate
Magnet	0.0001	10.0x10 <sup>9</sup>	MIL-HDBK-217
Standoff	0.0010	1 x 10 <sup>9</sup>	Engineering Estimate
Coil	0.0001	9.0x10 <sup>9</sup>	MIL-HDBK-217
LED	0.0029	350.0x10 <sup>6</sup>	MIL-HDBK-217
Photo Diode	0.0501	20.0x10 <sup>6</sup>	MIL-HDBK-217
Housing	0.0010	1 x 10 <sup>9</sup>	Engineering Estimate
Lead/Lead Wire Connections	0.1300	7.7x10 <sup>6</sup>	MIL-HDBK-217
Connector, Non-Feed Thru	0.1195	8.4x10 <sup>6</sup>	MIL-HDBK-217
Connector, Feed Thru	0.1195	8.4x10 <sup>6</sup>	MIL-HDBK-217

DRAFT

## 5.4 AVAILABILITY PREDICTION

Availability predictions were performed by developing fault trees using the FaultTree+ software. A fault tree was developed and an Availability prediction was performed on the HIF1 SUS and the HIF2 SUS. The following assumptions were made in performing the Availability predictions:

- $LOS1 = LOS2 = SOS$
- The MTBF for each Suspension Assembly = 20,205 hours
- The design margins on the structural components minimizes the failure rate. As a result, the probability of failure for each of the structural components is also low resulting in a minimal contribution to the overall availability calculation. Therefore, structural components were omitted from the fault tree for simplification purposes.
- The MDT associated with repair actions for SUS components located within the vacuum environment was assumed to be 72 hours.
- The MDT associated with repair actions for SUS Control Electronics located outside the vacuum environment was assumed to be 6 hours.

As a result of the predicted MTBF for each Suspension Assembly being less than the allocated MTBF, an adjustment to the MDT was required. The MDT adjustment was necessary in order to achieve the SUS allocated annual Availability in the LIGO 3X operating mode. Since the SUS Control Electronics will be located outside the vacuum environment and will not require a bake-out following a repair action, the MDT estimate was reduced to 6.0 hours. This remains a conservative estimate in that 6.0 hours is the maximum MDT which will still allow achievement of the SUS allocated annual Availability in the LIGO 3X operating mode.

The fault tree for the HIF1 SUS is provided in Appendix B. The calculations indicate that the HIF1 SUS Availability is 0.9960. Since the number of Suspension Assemblies is the same for the HIF1 SUS and the LIF1 SUS,  $A_{HIF1} = A_{LIF1} = 0.9960$ .

The fault tree for the HIF2 SUS is provided in Appendix C. The calculations indicate that the HIF2 SUS Availability is 0.9951.

Availability predictions were then performed for the three LIGO operating modes. Fault trees for the three LIGO operating modes were developed using the results of the HIF1 and HIF2 SUS availability predictions. The fault trees and Availability predictions for the three LIGO operating modes are provided in Appendices D through F. The results of the SUS availability predictions for each of the LIGO operating modes are summarized in Table 5-3 below.

TABLE 5-3: SUS Availability Predictions For The LIGO Operating Modes

<i>Mode of Operation</i>	<i>Allocated Annual Availability</i>	<i>Predicted Annual Availability</i>
3X	0.9839	0.9871
2X	0.9946	0.9959
1X	1.0000	1.0000

## 5.5 40 M MODEL TEST DATA

An evaluation of the 40 M Model test data with regards to the mechanical aspects of the 40 M Suspension Assemblies is presented in this section. At the time of this report, prototype full-scale LIGO SUS control electronic hardware was being installed, debugged and evaluated in the 40 M Model. A reliability assessment at this time would not be valid.

In July 1996, the Test Mass Suspension Assembly was installed into the 40M Model. The Test Mass Suspension Assembly of the 40M Model is a scaled down version of the LOS Suspension Assembly of the full-scale LIGO. As of the date of this report, there has only been one failure incident with the Test Mass Suspension Assembly. The failure incident occurred as the result of human error during installation and the occurrence of an earthquake. During installation, the gap between the test mass and the safety stop was set at 2 mm; not 1 mm as specified. As a result, when the earthquake occurred, the extra 1 mm of separation allowed the magnet/standoff assembly to contact the Photodiode and the magnet/standoff assembly separated from the test mass.

In December 1996, the Beam Splitter Suspension Assembly was installed into the 40M Model. The Beam Splitter Suspension Assembly of the 40M Model most closely approximates the SOS Suspension Assembly of the full-scale LIGO. As of the date of this report, there has been no failure occurrences with the Beam Splitter Suspension Assembly.

Since the one failure incident was not the result of a Suspension Assembly hardware failure, but rather the result of human error and an act of God, the failure is considered "non-relevant." This failure incident would not be charged against the Suspension Assembly in the calculation of a MTBF. However, the failure incident did result in the 40 M Model being inoperative for approximately one week as repairs were made. This results in an Unavailability of approximately 2% from July 1996 - July 1997.

## 6.0 CONCLUSIONS

The 40 M Test Data does not raise any serious concerns over the Suspension Assemblies achieving the predicted MTBF value. However, the one failure incident which did occur does raise some issues which warrant consideration.

First, procedures, processes and inspections should be reviewed and revised, as necessary, to preclude the reoccurrence of a failure due to human error during installation.

Second, spares policy and repair procedures need to be developed to ensure that the Mean-Down-Time associated with SUS repair actions is limited to 72 hours. The spares policy should evaluate the possibility of storing spares as pre-assembled subassemblies rather than as individual components which require assembly upon failure occurrence. This would help to reduce the Mean-Down-Time.

DRAFT

**APPENDIX A**

**SUS SUBASSEMBLY  
RELIABILITY PREDICTION**

**DRAFT**

Part Number :  
 Reference Des:  
 Date :August 04, 1997  
 Environment :Ground Benign  
 Temperature :40.0

Description :Suspension Assy  
 File Name :SUS2.TRE  
 Time : 2:31 p.m.  
 Failure Rate :1.182101  
 MTBF :845951.624490

Item	Description	Reference Designator	Quantity	Failure Rate	MTBF
Suspension Assy			1	1.182101	845951.624490
SUS1.SUB	Structural Frame	A1	1	0.009000	1.111110e+08
SUS2.SUB	Suspension Components	A2	1	0.007000	1.428570e+08
SUS3.SUB	Magnet/Standoff Assy	A3	6	0.006600	1.515150e+08
SUS4.SUB	Sensor/Actuator Head Assy	A4	5	0.920560	1.086290e+06
SUS5.SUB	Electrical Connections	A5	1	0.238940	4.185150e+06

Part Number :SUS01  
 Reference Des:A1  
 Date :August 04, 1997  
 Environment :Ground Benign  
 Temperature :40.0

Description :Structural Frame  
 File Name :SUS1.SUB  
 Time : 2:31 p.m.  
 Failure Rate :0.009000  
 MTBF :1.111110e+08

Record Number	Part Number	Description	Reference Designator	Failure Rate, Unit	Qty	Failure Rate, Total
1	A01	Height Adapter		0.001000	1	0.001000
2	A02	Stiffening Bars		0.001000	4	0.004000
3	A03	Support Structure		0.001000	1	0.001000
4	A04	Head Holder		0.001000	3	0.003000

Part Number :SUS02  
 Reference Des:A2  
 Date :August 04, 1997  
 Environment :Ground Benign  
 Temperature :40.0

Description :Suspension Components  
 File Name :SUS2.SUB  
 Time : 2:31 p.m.  
 Failure Rate :0.007000  
 MTBF :1.428570e+08

Record Number	Part Number	Description	Reference Designator	Failure Rate, Unit	Qty	Failure Rate, Total
1	B01	Wire Standoff		0.001000	2	0.002000
2	B02	Wire Guide Rod		0.001000	2	0.002000
3	B03	Suspension Block		0.001000	1	0.001000
4	B04	Crescent Wire Guide		0.001000	1	0.001000
5	B05	Suspension Wire		0.001000	1	0.001000

Part Number :SUS03  
 Reference Des:A3  
 Date :August 04, 1997  
 Environment :Ground Benign  
 Temperature :40.0

Description :Magnet/Standoff Assy  
 File Name :SUS3.SUB  
 Time : 2:31 p.m.  
 Failure Rate :0.001100  
 MTBF :9.090910e+08

Record Number	Part Number	Description	Reference Designator	Failure Rate, Unit	Qty	Failure Rate, Total
1	C01	Magnet		0.000100	1	0.000100
2	C02	Standoff		0.001000	1	0.001000



Part Number :SUS04  
 Reference Des:A4  
 Date :August 04, 1997  
 Environment :Ground Benign  
 Temperature :40.0

Description :Sensor/Actuator Head Assy  
 File Name :SUS4.SUB  
 Time : 2:31 p.m.  
 Failure Rate :0.184112  
 MTBF :5.431470e+06

Record Number	Part Number	Description	Reference Designator	Failure Rate, Unit	Qty	Failure Rate, Total
1	D01	Coil		0.000111	1	0.000111
2	TLN107A	LED		0.002882	1	0.002882
3	TPS703A	Photo Diode		0.050120	1	0.050120
4	D02	Housing		0.001000	1	0.001000
5	D03	Lead/Lead Wire Connection		0.013000	10	0.130000

Part Number :SUS05  
 Reference Des:A5  
 Date :August 04, 1997  
 Environment :Ground Benign  
 Temperature :40.0

Description :Electrical Connections  
 File Name :SUS5.SUB  
 Time : 2:31 p.m.  
 Failure Rate :0.238940  
 MTBF :4.185150e+06

Record Number	Part Number	Description	Reference Designator	Failure Rate, Unit	Qty	Failure Rate, Total
1	E02	Connector, Non Feed Thru		0.119470	1	0.119470
2	E03	Connector, Feed Thru		0.119470	1	0.119470

**APPENDIX B**

**SUS PREAMPLIFIER**  
**RELIABILITY PREDICTION**

**DRAFT**

Part Number :SUS06  
 Reference Des:A6  
 Date :August 04, 1997  
 Environment :Ground Benign  
 Temperature :35.0

Description :Preamplifier  
 File Name :SUS6.SUB  
 Time : 2:33 p.m.  
 Failure Rate :9.240857  
 MTBF :108215.065929

Record Number	Part Number	Description	Reference Designator	Failure Rate, Unit	Qty	Failure Rate, Total
1	F01	I/O Connectors		0.002387	2	0.004775
2	LT1125	Quad Op Amp		0.118287	17	2.010876
3	LM6321	High Speed Buffer		0.299236	11	3.291601
4	RC	Resistors		0.014569	60	0.874162
5	CK	Capacitors, 0.1uF		0.019775	63	1.245850
6	LM78L15	+15 Volt Regulator		0.522106	3	1.566317
7		Connector	J4	0.047746	1	0.047746
8		Connector	J3	0.047746	1	0.047746
9		Connector	J5	0.047746	1	0.047746
10		PCB		0.104040	1	0.104040

**APPENDIX C**

**SUS CONTROLLER  
RELIABILITY PREDICTION**

**DRAFT**

Part Number :  
 Reference Des:  
 Date :August 04, 1997  
 Environment :Ground Benign  
 Temperature :35.0

Description :Suspension Controller  
 File Name :SUS7.TRE  
 Time : 2:35 p.m.  
 Failure Rate :39.070102  
 MTBF :25595.018806

Item	Description	Reference Designator	Quantity	Failure Rate	MTBF
SUS CONTROLLER			1	39.070102	25595.018806
MAIN.SUB	Main Board	A1	1	6.028522	165878.144605
INPUT.SUB	Input SIP	A1A1-A1A3	3	3.868509	258497.550383
POSTIN.SUB	Post In SIP	A1A4 - A1A5	2	5.441164	183784.215950
COILDRV.SUB	Coil Driver SIP	A1A6 - A1A10	5	5.919658	168928.691541
FILTER.SUB	Filter SIP	A1A11 - A1A15	5	12.141887	82359.520263
LSCIN.SUB	LSC SIP	A1A16	1	3.076556	325038.795950
OUTPUT.SUB	Output SIP	A1A17	1	2.593808	385533.596912

Part Number :D961290  
 Reference Des:A1A6 - A1A10  
 Date :August 04, 1997  
 Environment :Ground Benign  
 Temperature :35.0

Description :Coil Driver SIP  
 File Name :COILDRV.SUB  
 Time : 2:35 p.m.  
 Failure Rate :1.183932  
 MTBF :844643.457706

Record Number	Part Number	Description	Reference Designator	Failure Rate, Unit	Qty	Failure Rate, Total
1	LT1125	Quad Op Amp		0.118287	1	0.118287
2	LM6321	High Speed Buffer		0.299236	2	0.598473
3	RC	Resistors		0.014569	10	0.145694
4	CK	Capacitors		0.019775	9	0.177979
5		SIP Connector	P1	0.095492	1	0.095492
6		SIP PCB		0.048008	1	0.048008

Part Number :D961291  
 Reference Des:A1A11 - A1A15  
 Date :August 04, 1997  
 Environment :Ground Benign  
 Temperature :35.0

Description :Filter SIP  
 File Name :FILTER.SUB  
 Time : 2:35 p.m.  
 Failure Rate :2.428377  
 MTBF :411797.601313

Record Number	Part Number	Description	Reference Designator	Failure Rate, Unit	Qty	Failure Rate, Total
1	LT1125	Quad Op Amp		0.118287	2	0.236574
2	RC	Resistors		0.014569	24	0.349665
3	CK	Capacitors, 0.1uF		0.019775	18	0.355957
4		SIP Connector	P1	0.095492	1	0.095492
5		SIP PCB		0.018462	1	0.018462
6	LM6321	High Speed Buffer		0.299236	4	1.196946
7	MAX333	Quad SPDT Switch		0.084360	1	0.084360
8	CK	Capacitors, 0.47uF		0.022731	4	0.090923



Part Number :D961293  
 Reference Des:A1A1-A1A3  
 Date :August 04, 1997  
 Environment :Ground Benign  
 Temperature :35.0

Description :Input SIP  
 File Name :INPUT.SUB  
 Time : 2:35 p.m.  
 Failure Rate :1.289503  
 MTBF :775492.651149

Record Number	Part Number	Description	Reference Designator	Failure Rate, Unit	Qty	Failure Rate, Total
1	LT1125	Quad Op Amp		0.118287	1	0.118287
2	RC	Resistors		0.014569	16	0.233110
3	CK	Capacitors, 0.1uF		0.019775	4	0.079102
4		SIP Connector	P1	0.095492	1	0.095492
5		SIP PCB		0.058480	1	0.058480
6	1N4148-1	Diode, General Purpose		0.011378	8	0.091021
7	MAX509	Quad Serial 8-Bit DAC		0.614012	1	0.614012

Part Number :D961295  
 Reference Des:A1A16  
 Date :August 04, 1997  
 Environment :Ground Benign  
 Temperature :35.0

Description :LSC SIP  
 File Name :LSCIN.SUB  
 Time : 2:35 p.m.  
 Failure Rate :3.076556  
 MTBF :325038.795950

Record Number	Part Number	Description	Reference Designator	Failure Rate, Unit	Qty	Failure Rate, Total
1	LT1125	Quad Op Amp		0.118287	2	0.236574
2	RC	Resistors		0.014569	19	0.276818
3	CK	Capacitors, 0.1uF		0.019775	20	0.395508
4		SIP Connector	P1	0.095492	1	0.095492
5		SIP PCB		0.024956	1	0.024956
6	1N4148-1	Diode, General Purpose		0.011378	8	0.091021
7	MAX509	Quad Serial 8-Bit DAC		0.614012	1	0.614012
8	DG191A	Dual JFET SPDT Switch		0.072615	2	0.145230
9	LM6321	High Speed Buffer		0.299236	4	1.196946

Part Number :D961288  
 Reference Des:A1  
 Date :August 04, 1997  
 Environment :Ground Benign  
 Temperature :35.0

Description :Main Board  
 File Name :MAIN.SUB  
 Time : 2:35 p.m.  
 Failure Rate :6.028522  
 MTBF :165878.144605

Record Number	Part Number	Description	Reference Designator	Failure Rate, Unit	Qty	Failure Rate, Total
1	LT1125	Quad Op Amp		0.118287	8	0.946295
2	RC	Resistors		0.014569	67	0.976147
3	CK	Capacitors, 0.1uF		0.019775	37	0.731690
4		SIP Connector	P1	0.095492	1	0.095492
5		SIP PCB		0.018904	1	0.018904
6	MAX532	Dual Serial 12-Bit DAC		0.888347	1	0.888347
7	DG211	Quad SPST Switch		0.084360	5	0.421798
8	LM78L15	+15 Volt Regulator		0.522106	2	1.044212
9	CK	Capacitors, 1.0uF		0.024329	24	0.583897
10	CK	Capacitors, 5.6uF		0.028409	6	0.170456
11	CK	Capacitors, 22uF		0.032132	4	0.128530
12	1N4148-1	Diode, General Purpose		0.011378	2	0.022755

Part Number :D961292  
 Reference Des:A1A17  
 Date :August 04, 1997  
 Environment :Ground Benign  
 Temperature :35.0

Description :Output SIP  
 File Name :OUTPUT.SUB  
 Time : 2:35 p.m.  
 Failure Rate :2.593808  
 MTBF :385533.596912

Record Number	Part Number	Description	Reference Designator	Failure Rate, Unit	Qty	Failure Rate, Total
1	LT1125	Quad Op Amp		0.118287	1	0.118287
2	RC	Resistors		0.014569	16	0.233110
3	CK	Capacitors, 0.1uF		0.019775	6	0.118652
4		SIP Connector	P1	0.095492	1	0.095492
5		SIP PCB		0.072454	1	0.072454
6	1N4148-1	Diode, General Purpose		0.011378	10	0.113776
7	MAX509	Quad Serial 8-Bit DAC		0.614012	3	1.842037

Part Number :D961294  
 Reference Des:A1A4 - A1A5  
 Date :August 04, 1997  
 Environment :Ground Benign  
 Temperature :35.0

Description :Post In SIP  
 File Name :POSTIN.SUB  
 Time : 2:35 p.m.  
 Failure Rate :2.720582  
 MTBF :367568.431900

Record Number	Part Number	Description	Reference Designator	Failure Rate, Unit	Qty	Failure Rate, Total
1	LT1125	Quad Op Amp		0.118287	3	0.354860
2	RC	Resistors		0.014569	37	0.539066
3	CK	Capacitors, 0.1uF		0.019775	18	0.355957
4		SIP Connector	P1	0.095492	1	0.095492
5		SIP PCB		0.018904	1	0.018904
6	MAX532	Dual Serial 12-Bit DAC		0.888347	1	0.888347
7	DG211	Quad SPST Switch		0.084360	1	0.084360
8	LM6321	High Speed Buffer		0.299236	1	0.299236
9	MAX333	Quad SPDT Switch		0.084360	1	0.084360

**APPENDIX D**

**HIF1 SUS**

**AVAILABILITY PREDICTION**

**DRAFT**

NOTES:

1. M = Mean-Time-Between-Failure (MTBF) in hours.
2. F = Fixed Unavailability determined by previous calculation.
3. MDT = Mean-Down-Time = 72.0 hours unless stated otherwise.

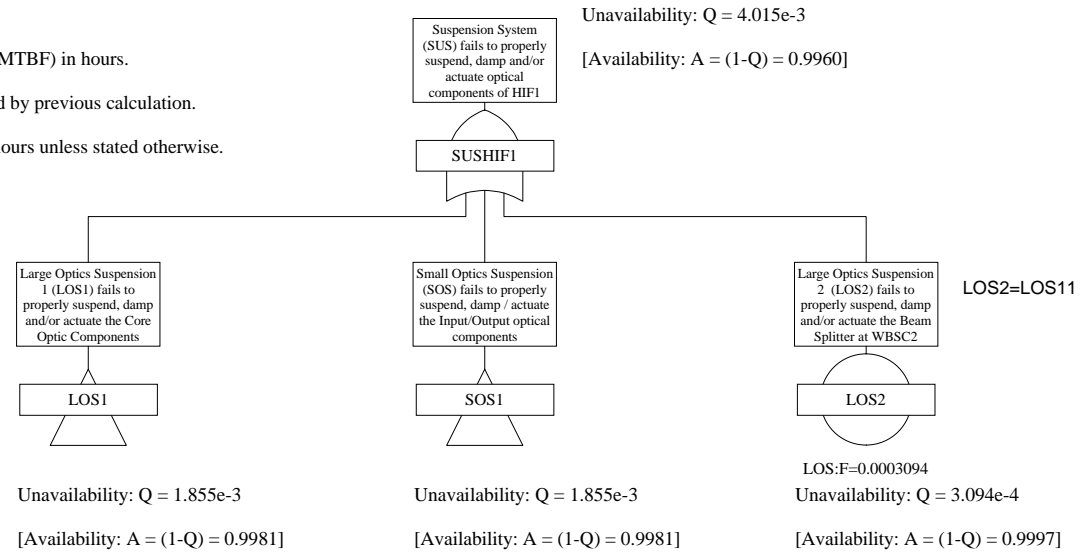

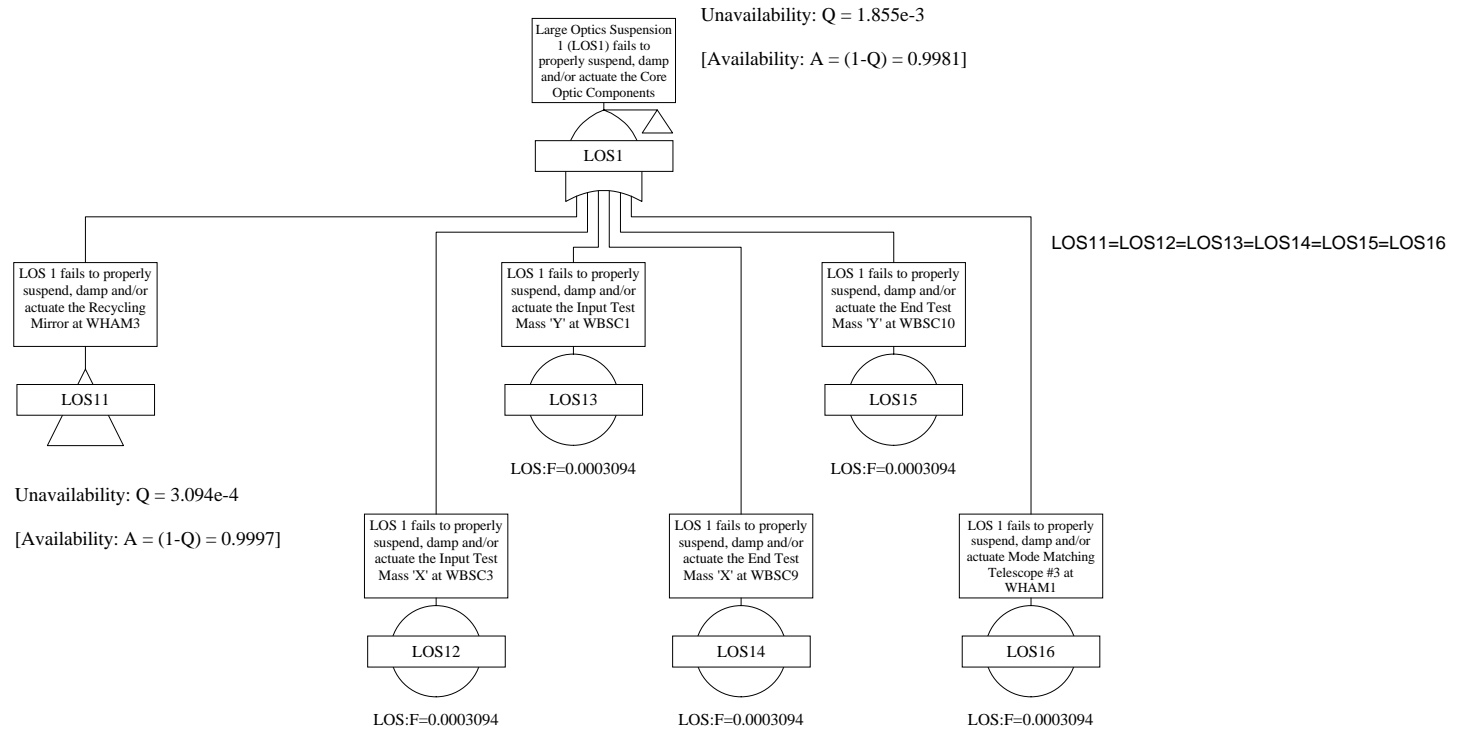



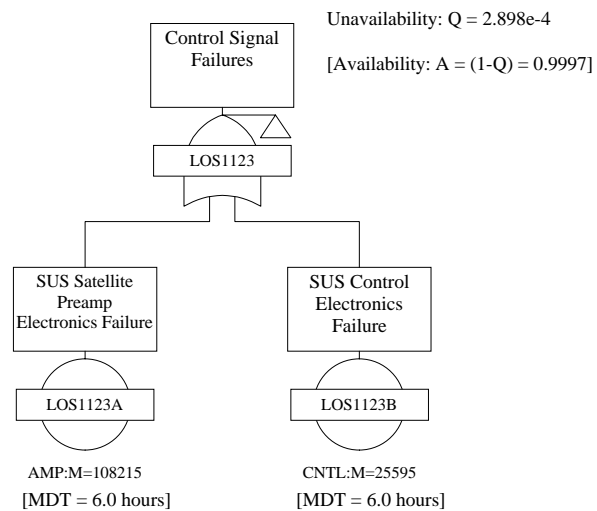

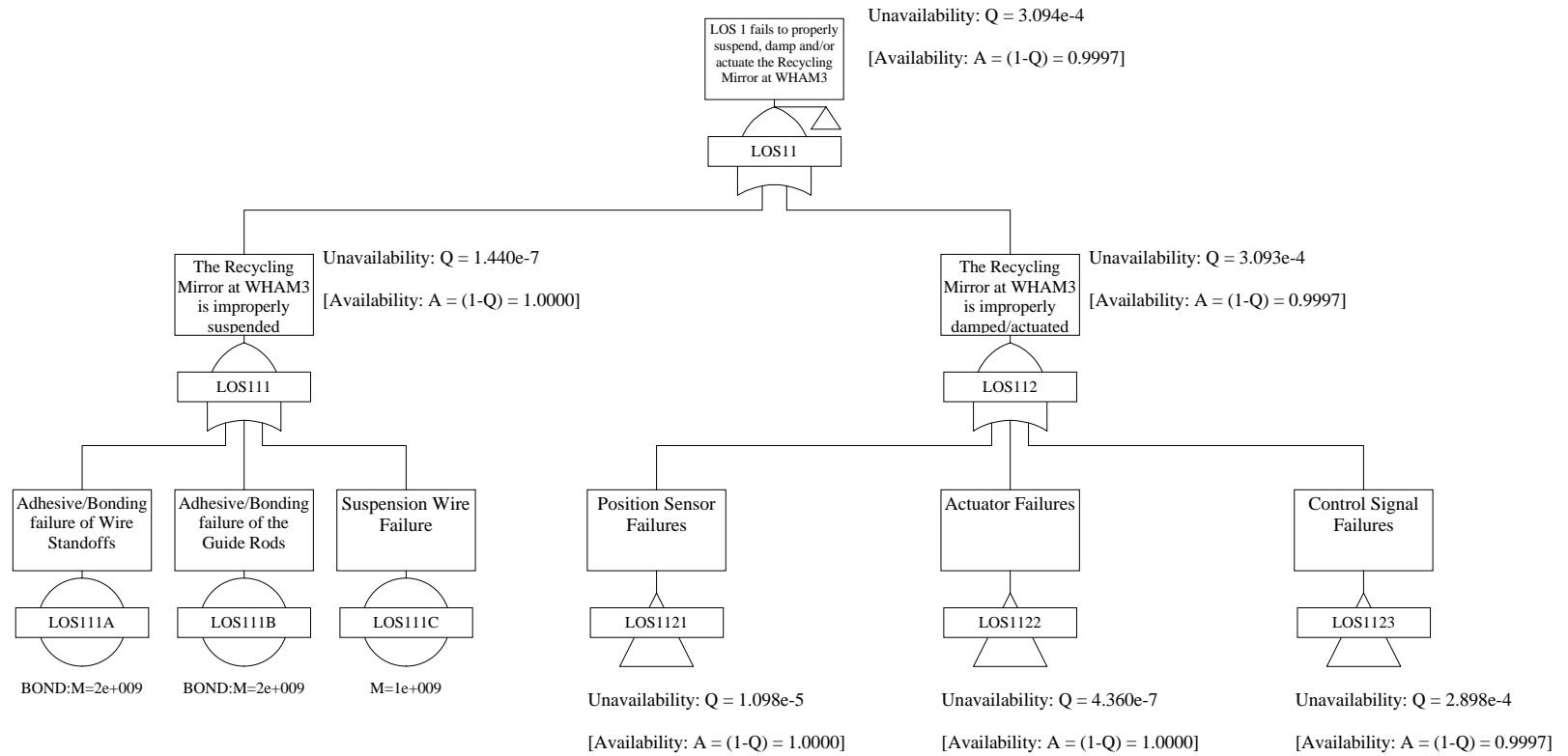

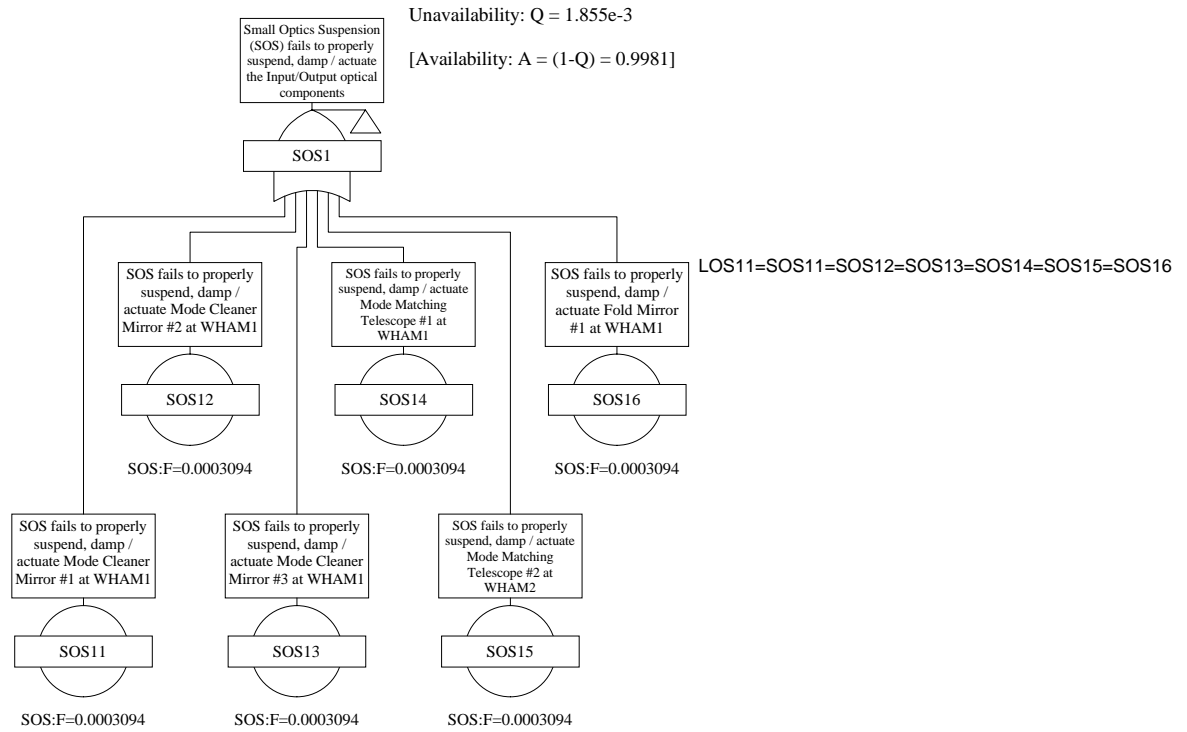

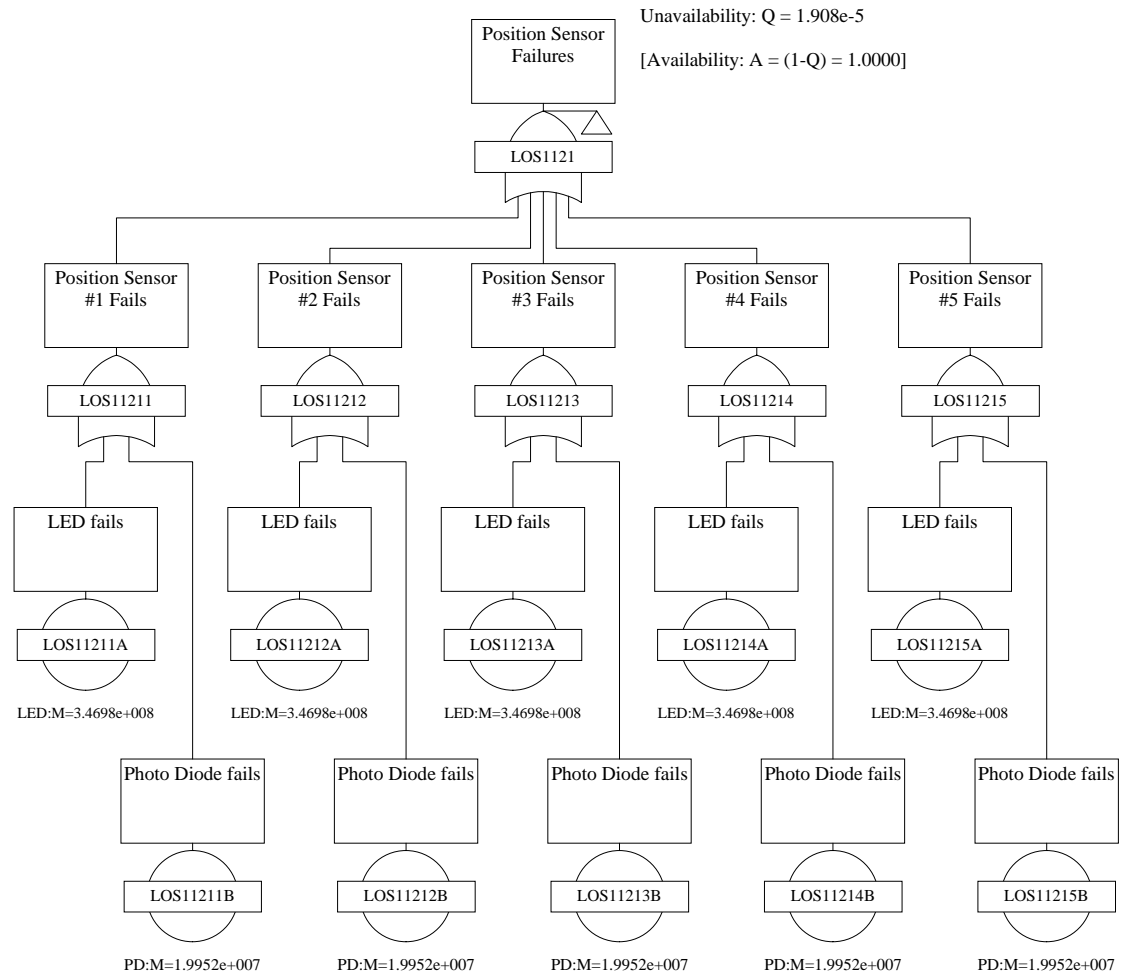



**APPENDIX E**

**HIF2 SUS**

**AVAILABILITY PREDICTION**

**DRAFT**

NOTES:

1. M = Mean-Time-Between-Failure (MTBF) in hours.
2. F = Fixed Unavailability determined by previous calculation.
3. MDT = Mean-Down-Time = 72.0 hours unless stated otherwise.

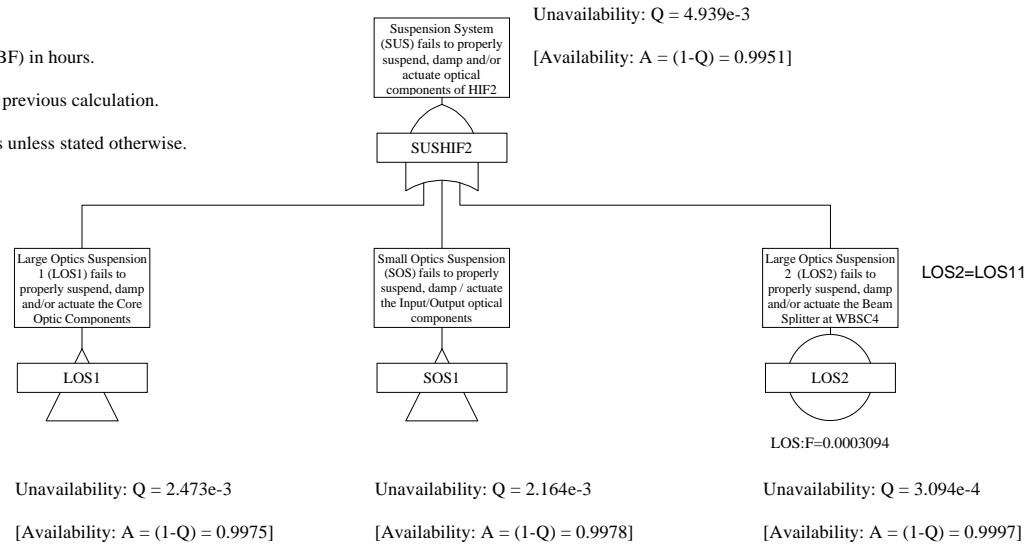

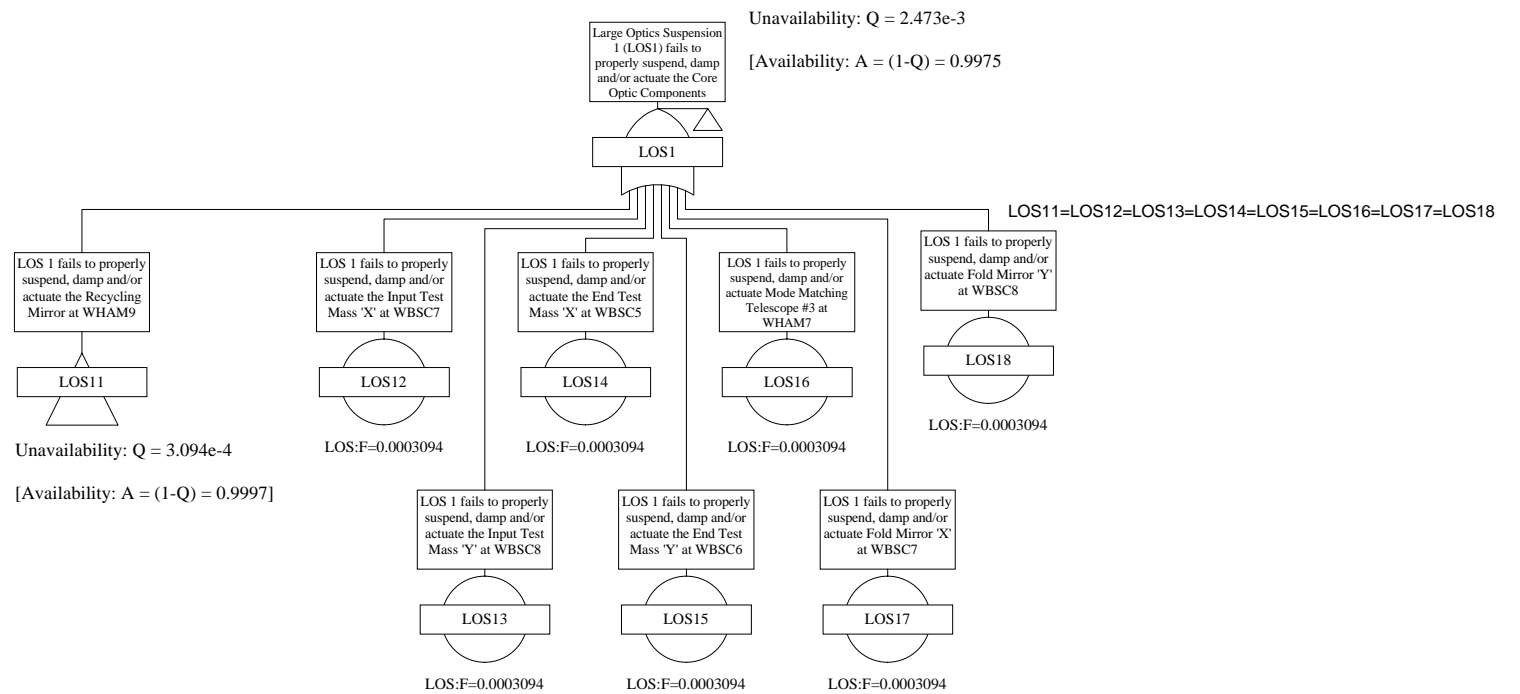



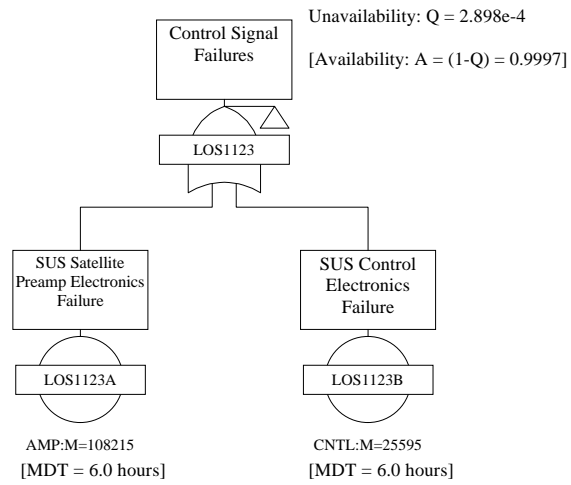

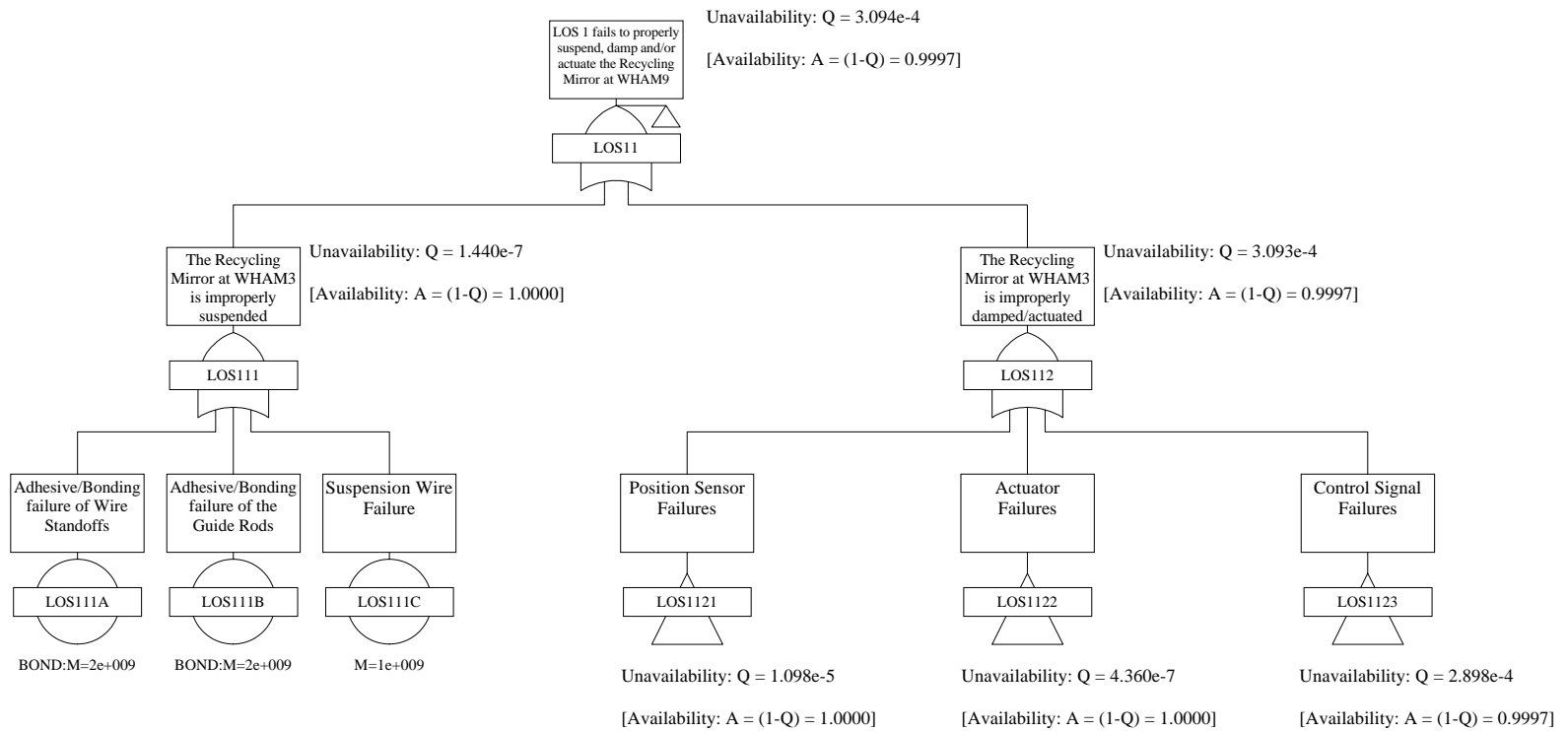

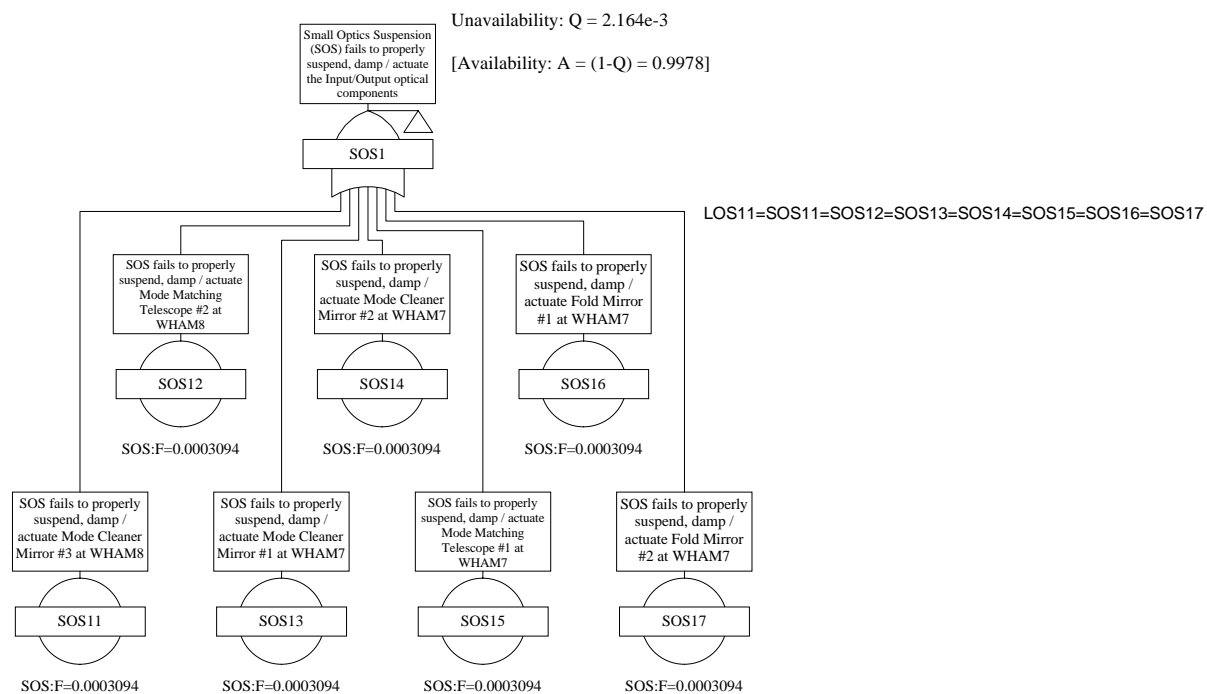

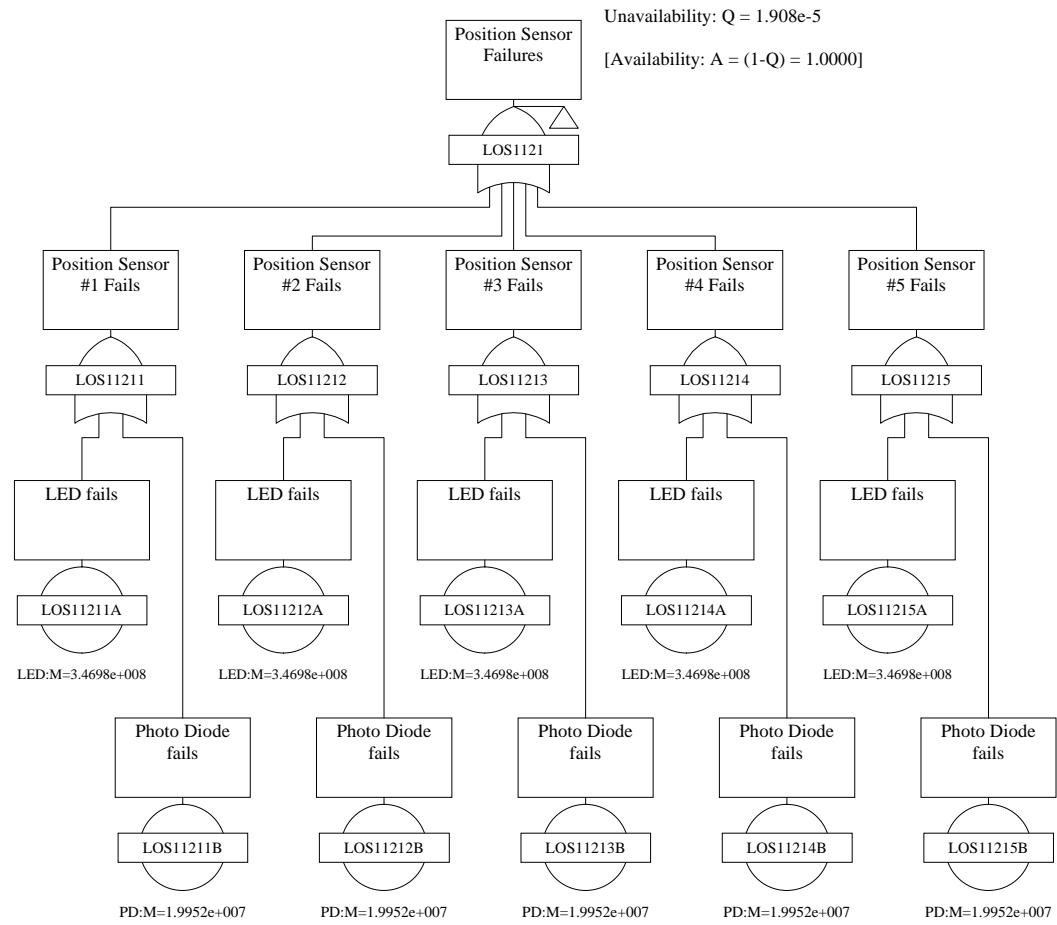



**APPENDIX F**

**LIGO 3X:**

**SUS AVAILABILITY PREDICTION**

**DRAFT**

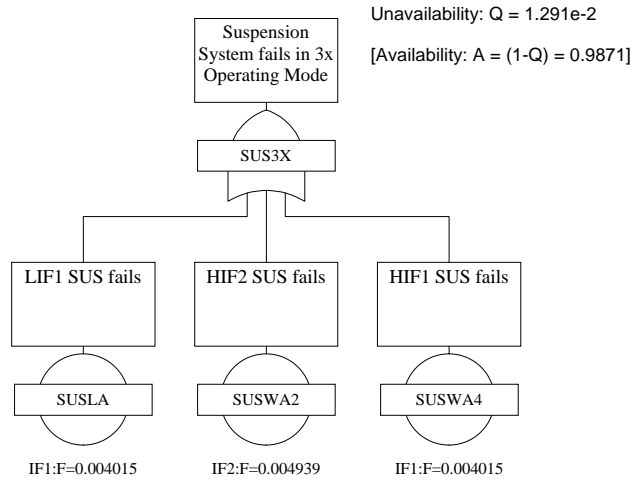

## APPENDIX G

# LIGO 2X: SUS AVAILABILITY PREDICTION

DRAFT



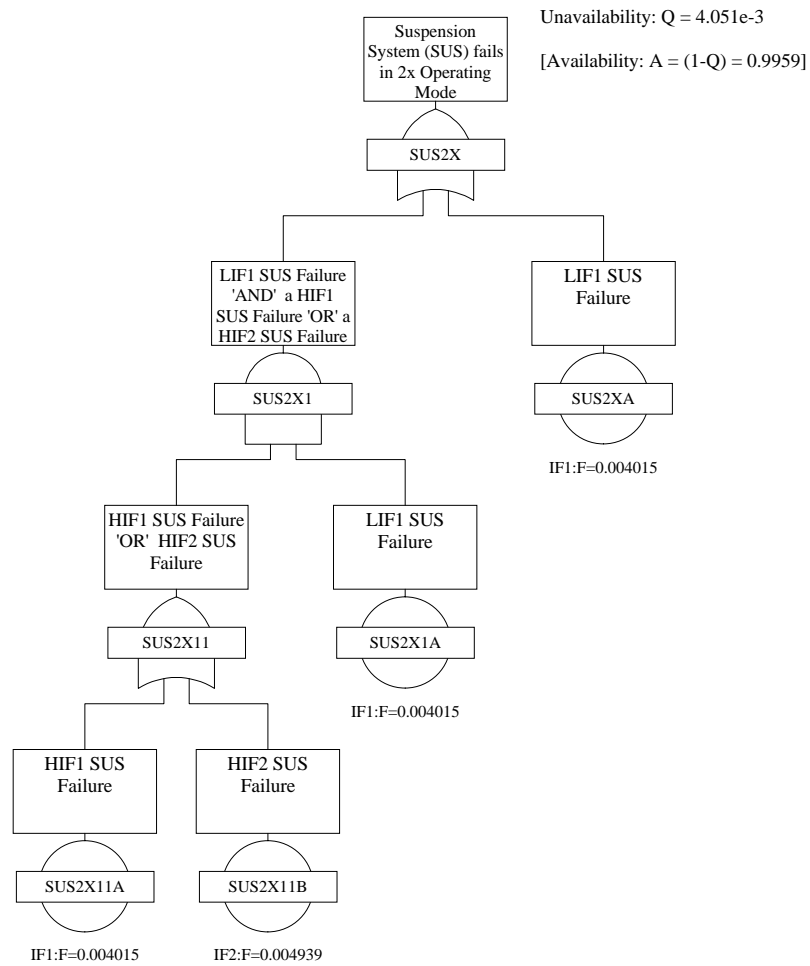

**APPENDIX H**

**LIGO 1X:**

**SUS AVAILABILITY PREDICTION**

**DRAFT**

