

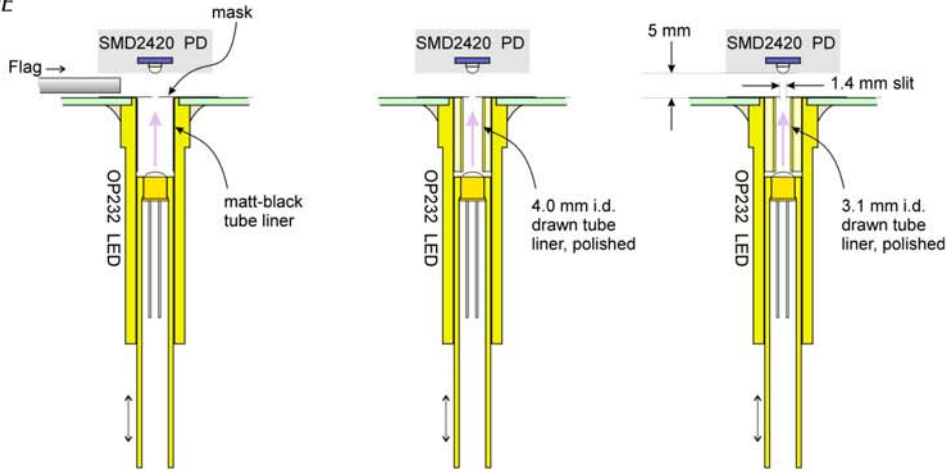

OP232 IR LED + SMD2420 Photodiode: output vs flag displacement

UNIVERSITY OF STRATHCLYDE



Apparatus: A

B

C

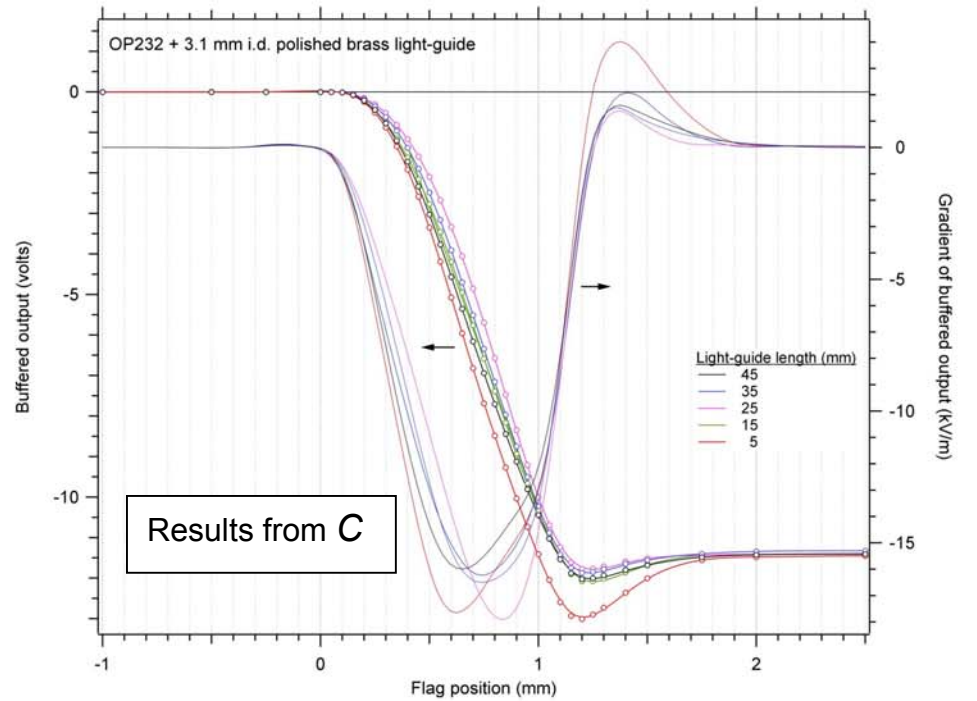
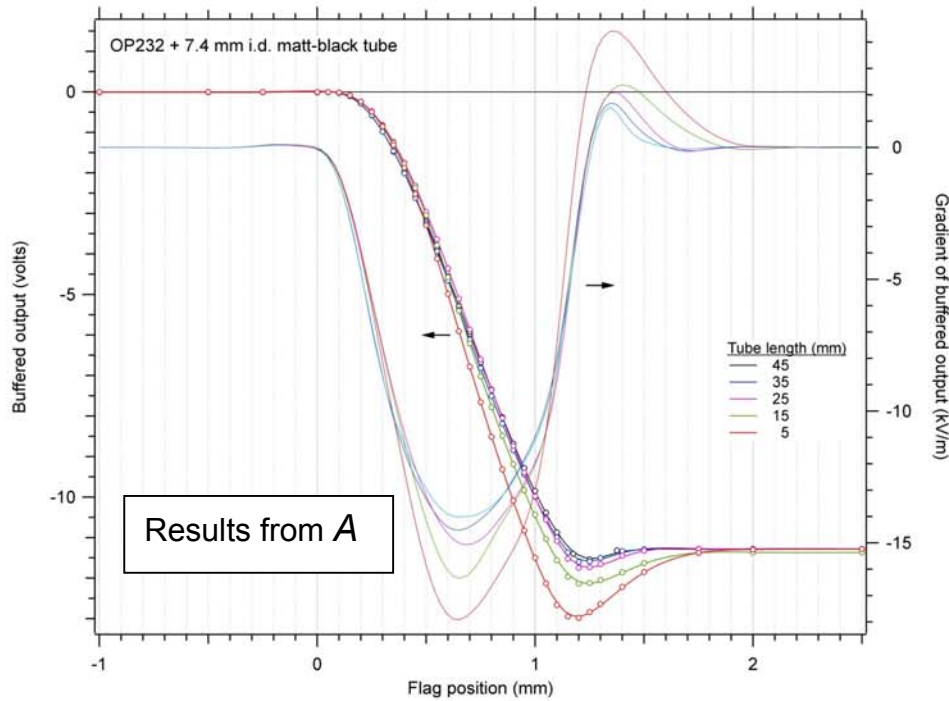
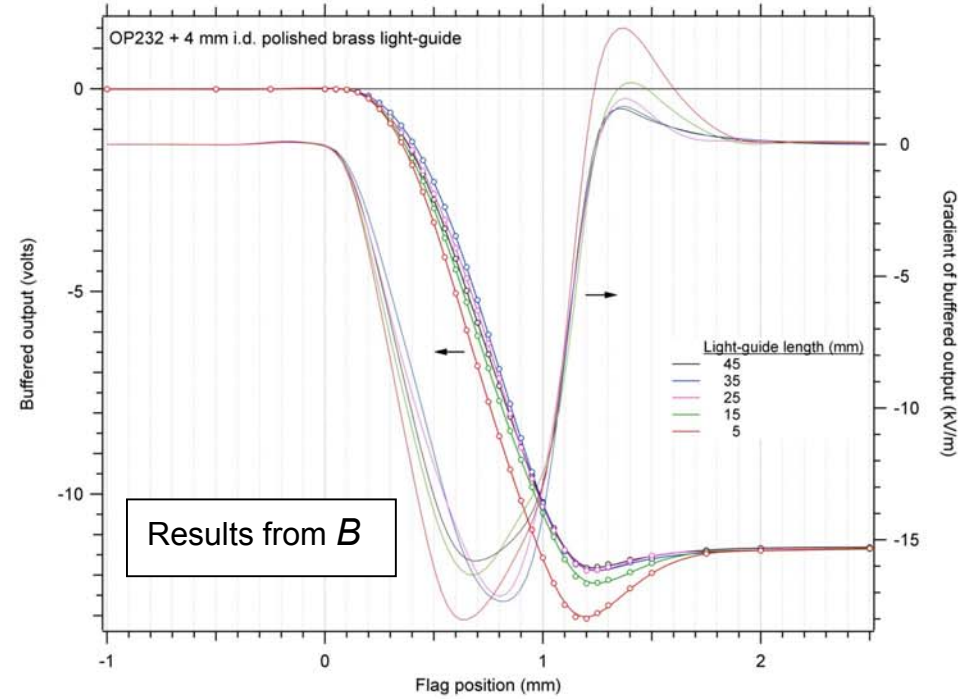

OP232 IR LED + SMD2420 Photodiode + 3.1 mm i.d. light-guide: noise performance as a function of light-guide length

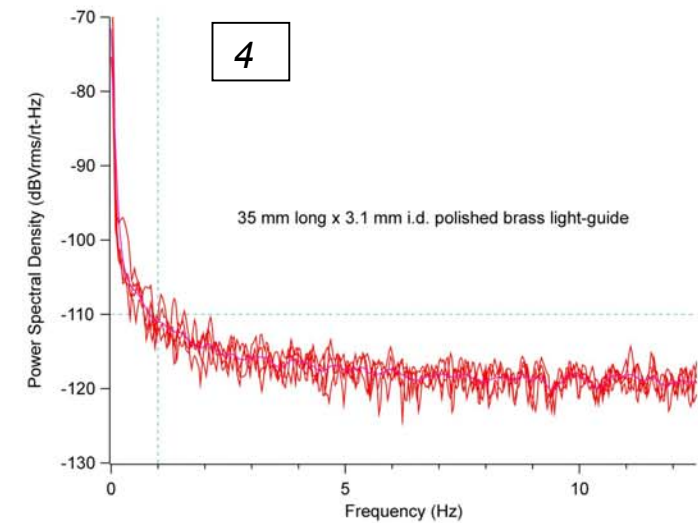
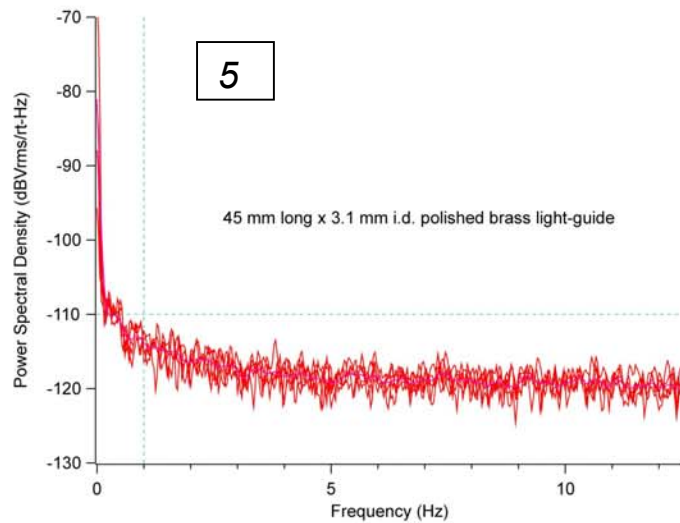
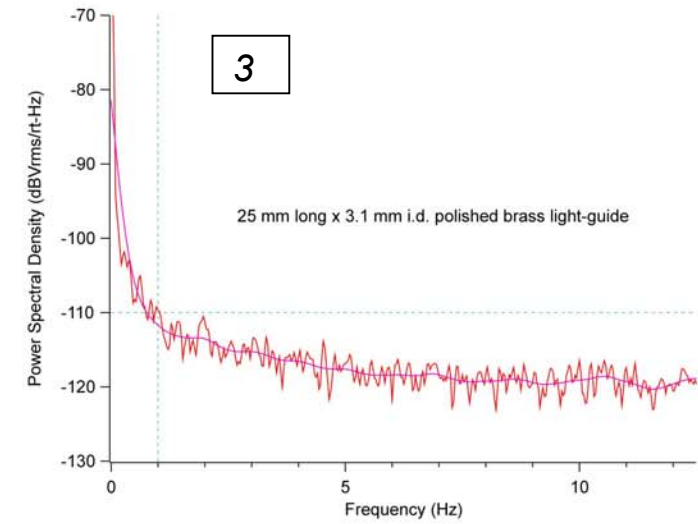
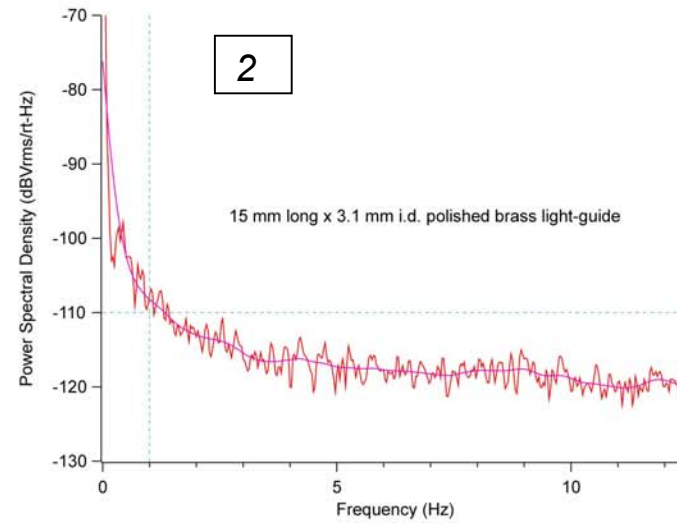
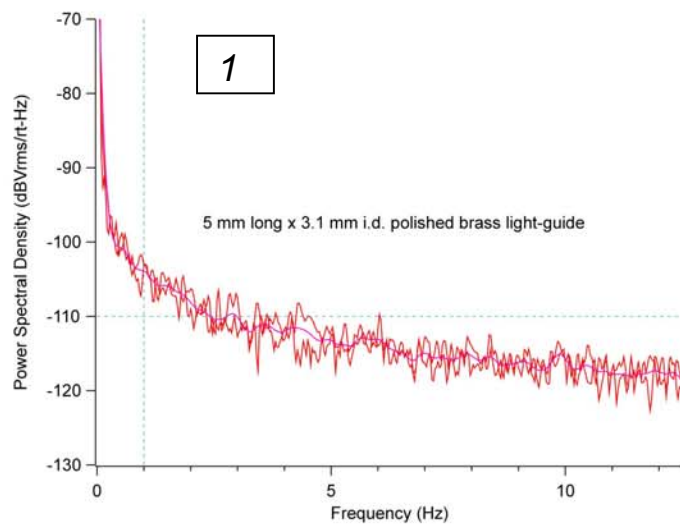

Clockwise from top left: increasing the 3.1 mm i.d. light-guide's length from 5 mm, in steps of 10 mm (the apparatus that was used is shown schematically in diagram C, above). Note that between figures 1 and 5 the noise level in the frequency range of approximately 1 Hz, and below, progressively reduced as the light-guide was made longer. Indeed, at 1 Hz the reduction in noise level over this range approached 10 dB; and this occurred despite the fact that the mean photocurrent in the SMD2420 detector decreased between figures 1 and 5, thereby *increasing* the level of shot noise in the detector from -121.9 dB in figure 1, to -120.1 dB in figure 5.

OP232 infrared LED + lens + SMD2420 Photodiode: comparative displacement sensitivity

Apparatus: 2 x 16 mm focal length plano-convex lenses, as a doublet (focal length approx. 8 mm). The overall length of the assembly could be just 20 mm.

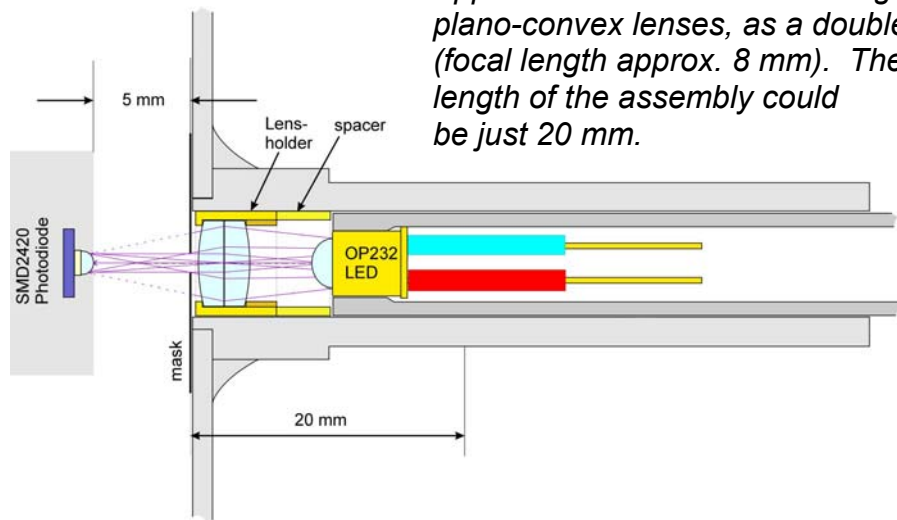

slit in mask: 1.4 mm x 4.5 mm

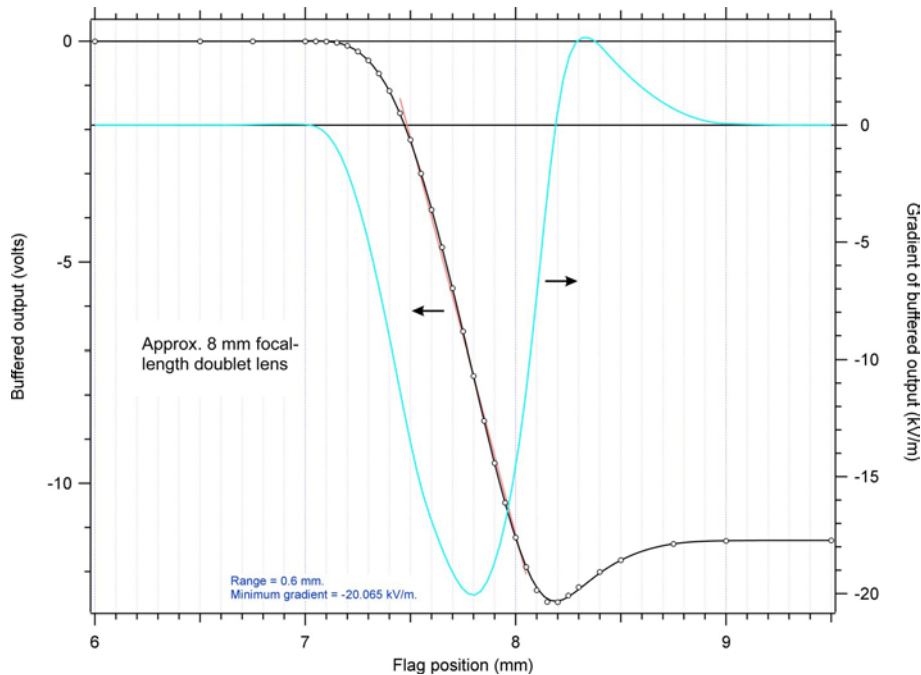

Buffered output from the SMD2420 photodiode as a function of flag position.

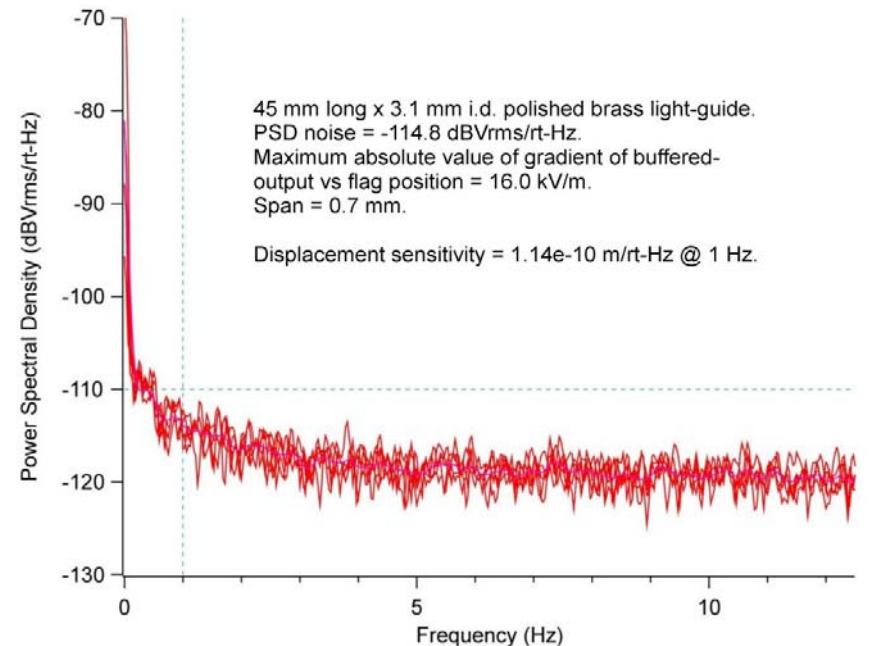
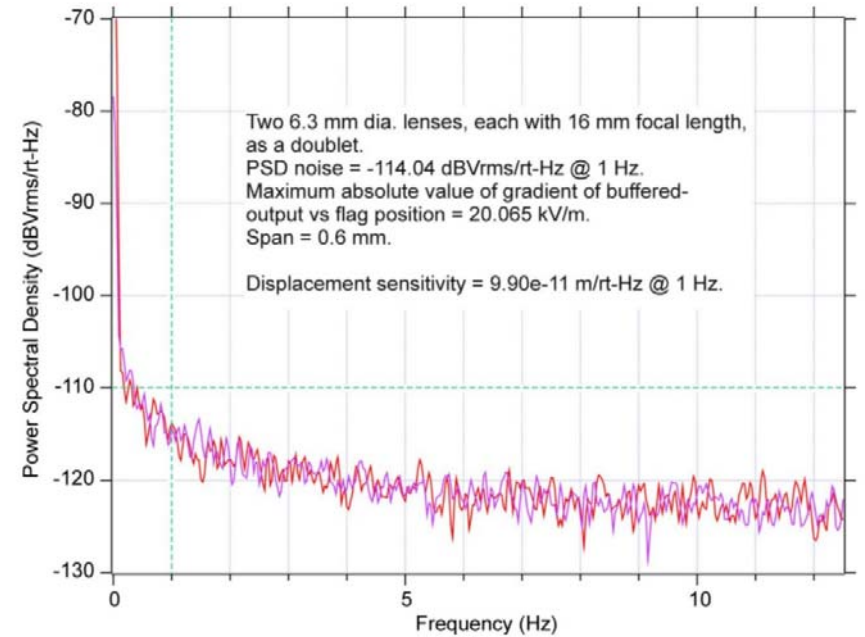

Noise comparison: Lensed (upper) and 45 mm lightguide (lower).

Reliability of the OP232 infrared LED: MTBF apparatus for the simultaneous testing of 24 x OP232 LEDs

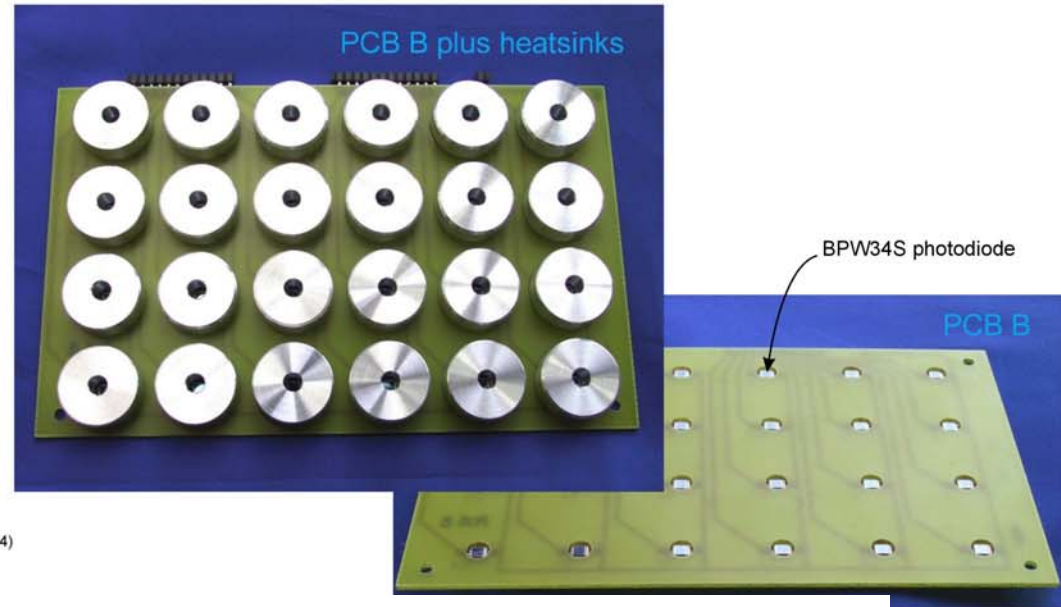
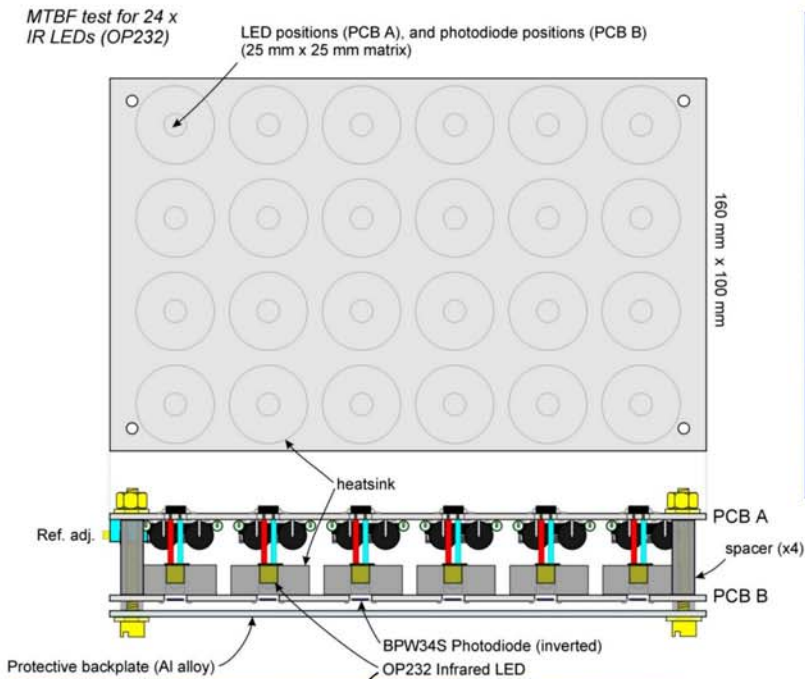

Array of photodetectors.

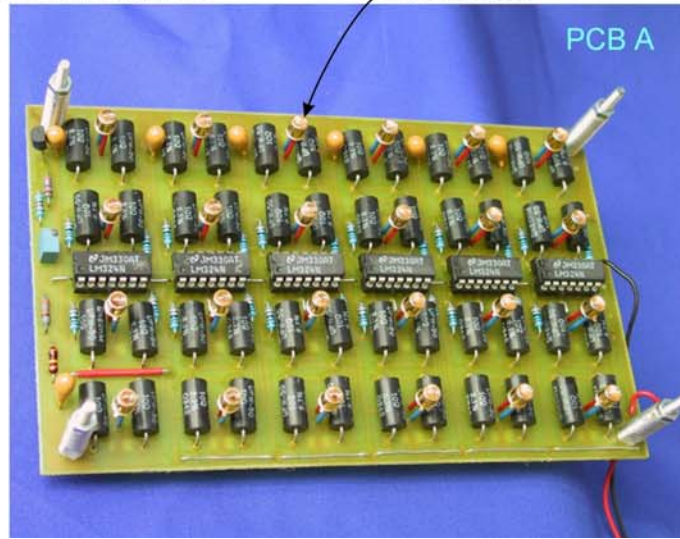

24 x 100 mA current sources, each supplying a single OP232 LED.

The short-circuit photocurrent from each of the $24 \times$ BPW34S photodiodes is being monitored on a daily basis, in order to check the function of its corresponding OP232 LED.

The mean photocurrent = 2.2 mA, the spread in value of the 24 photocurrents having a standard deviation of 0.35 mA.

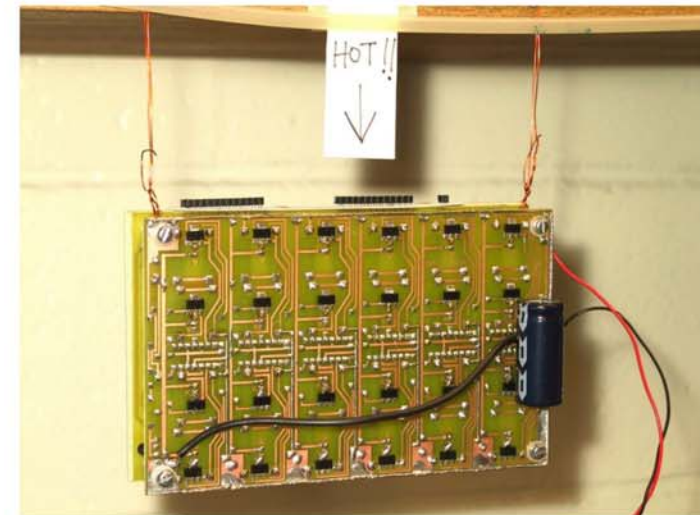

Apparatus in use: 24/08/2004—