



LIGO Laboratory / LIGO Scientific Collaboration

LIGO-T060250-00-R

LIGO

October 2006

User's guide for the 40mInLockState package
in e2e framework

Monhica Varvella

Distribution of this document:
LIGO Science Collaboration

This is an internal working note
of the LIGO Project.

California Institute of Technology
LIGO Project – MS 18-34
1200 E. California Blvd.
Pasadena, CA 91125
Phone (626) 395-2129
Fax (626) 304-9834
E-mail: info@ligo.caltech.edu

Massachusetts Institute of Technology
LIGO Project – NW17-161
175 Albany St
Cambridge, MA 02139
Phone (617) 253-4824
Fax (617) 253-7014
E-mail: info@ligo.mit.edu

LIGO Hanford Observatory
P.O. Box 1970
Mail Stop S9-02
Richland WA 99352
Phone 509-372-8106
Fax 509-372-8137

LIGO Livingston Observatory
P.O. Box 940
Livingston, LA 70754
Phone 225-686-3100
Fax 225-686-7189

<http://www.ligo.caltech.edu/>

1. Introduction

This package consist in a dual recycled interferometer implemented in e2e framework : the configuration implemented is the one of the 40m and the parameters corresponds to 40m parameters. Four directories are included in this package named «Boxes», «Data», «Figures» and «e2eBoxes». A *README* file is included also.

1.1. Boxes

This directory contains the files .box used by e2e to run the program. The main box is called *DualIFO.box* and it is shown in Figure (1).

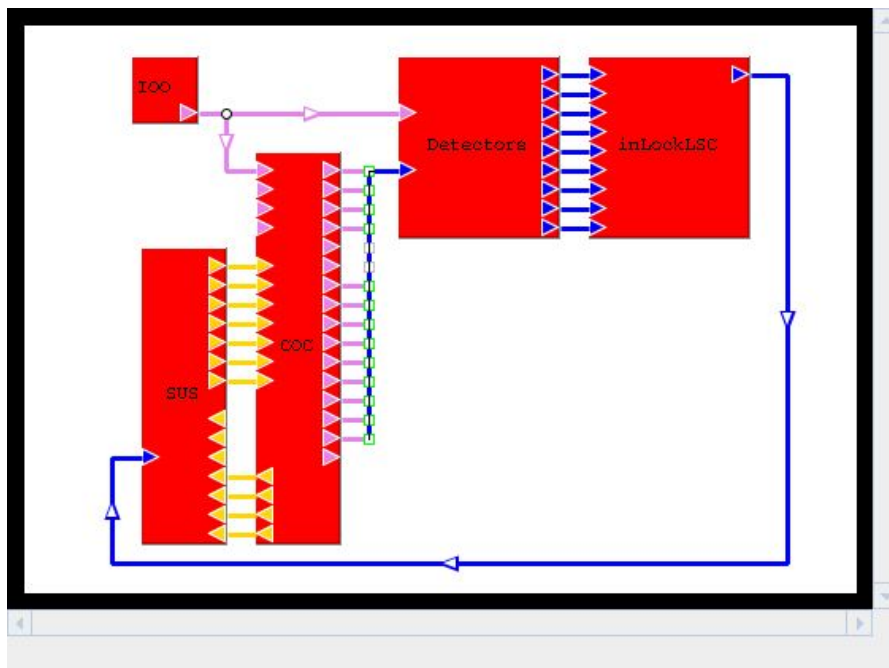

Figure 1 Main box: DualIFO.box

The *DualIFO.box* includes the most important subsystems of the configuration:

- the PSL, the Mach-Zehnder interferometer to avoid sidebands of sidebands and the EOMs in series are included in *IOO.box*; it is possible to choose the number of sidebands wanted in the simulation using the « sideband_filter » module ;
- the core optics for this kind of configuration is included in *COC.box* : the dual summation cavity is implemented for the central part of the interferometer ; the radiation pressure is implemented on the arms mirrors and power meters have been added to monitor the cavities power ;

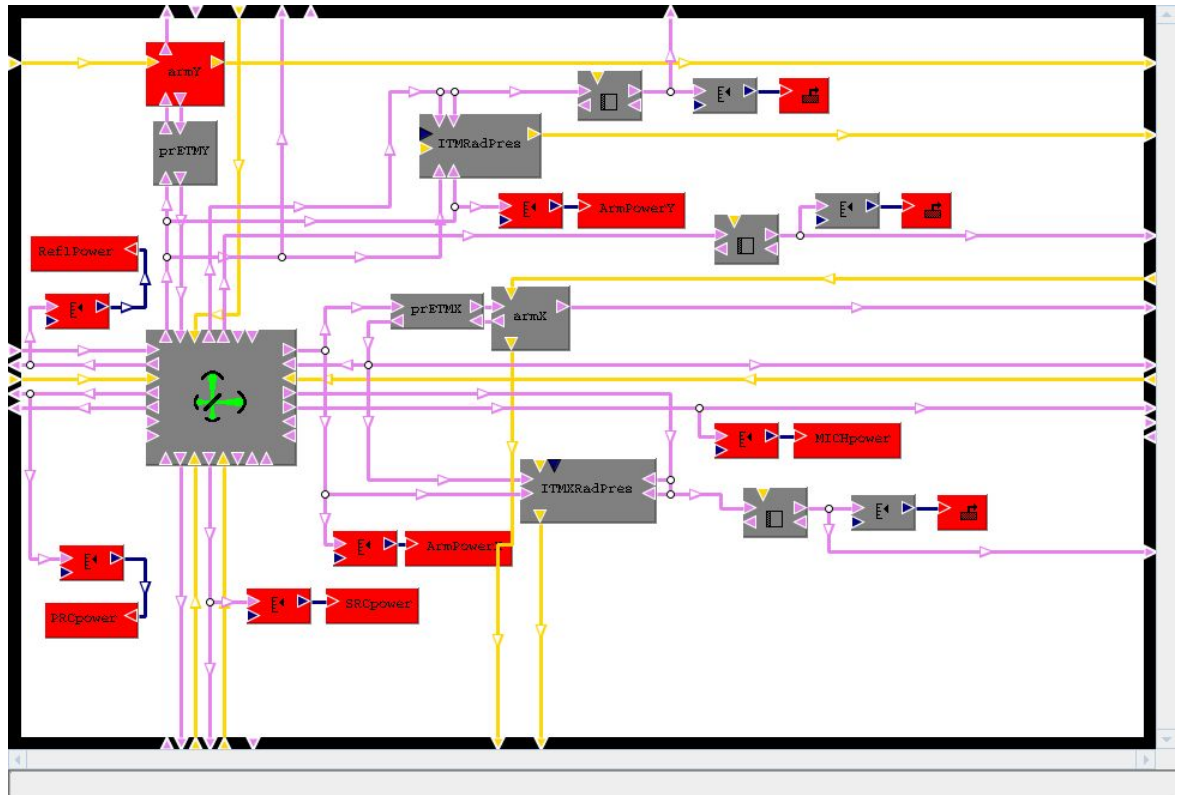

Figure 2 Core optics for a dual recycled interferometer

- the photo-detectors are implemented in the *Detectors.box* file : there are detectors for the monitoring of the input fields and also the fields at all the other ports at carrier and sidebands, that is Dark Port (AP), Symmetric Port (SP), arms pick-off (POX and POY), beam-splitter pick-off (POB), arms cavities pick-off ;
- the control system is implemented in *inLockLSC.box* : the inputmatrix is implemented in the *Matrix.box* file that contains the channels used to build the error signals and the control signals ; the output matrix is implemented in the ControlSystem. A shaker is inserted in order to simulate the open loop transfer functions of the outputs and of degrees of freedom.
- the suspensions for the seven mirrors are included in *SUS.box* : each mirrors has a dedicated box, but the setting is pretty similar. In this configuration the suspension is made just by a simple pendulum. Each suspension can be affected by seismic noise and radiation pressure force ; the seismic noise implemented is very quiet and consists in a quadrupole pole at 1Hz. A more realistic seismic model will be implemented in another package. The total

force is sent to the mirrors to move them with a differential motion. In *SUS.box* a shaker is implemented in order to perform the simulation with *modeler_freq*.

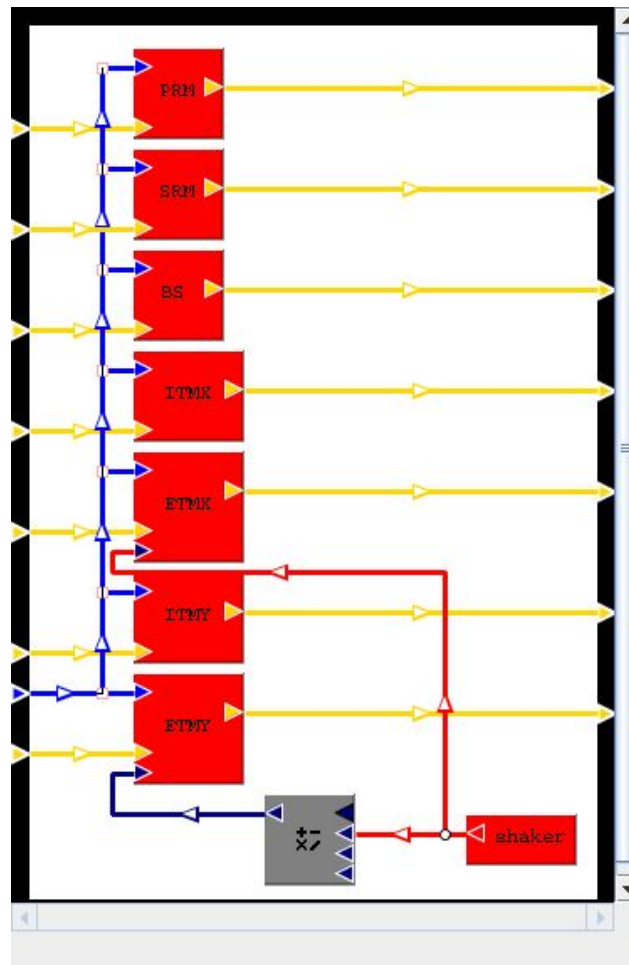

Figure 3 Suspensions : SUS.box

The «Boxes» directory contains also the macro files *e2eDB.mcr*, *40m.mcr* and *MZ.mcr* where the general parameters of the interferometer configuration and of the Mach-Zehnder are defined. It is possible to change most of the parameters using these macros.

There are also some parameters files (.par) including values which need to change during a simulation: it is possible that some values are not fixed and need to change all along the simulation. For instance, *40mLockSeismic.par* (seismic noise included) and *40mLockNoSeismic.par* (no seismic noise included) set parameters for the simulation of the lock acquisition of the dual recycled interferometer in the time domain. *40mLockNoSeismic.par* (no seismic noise included) is also used for the simulation of the optical response of the cavity in the frequency domain.

In addition there are some input files (.in) to let run a simulation with defined options : in this way the user is not obliged to type a series of options before starting a simulation ; it is worth to note that the input file for *modeler* and *modeler_freq* has different options. *40mLock.in* is used to run *modeler* and uses the *40mLockSeismic.par* file. *OptResp.in* is used to run *modeler_freq* and uses the *40mLockNoSeismic.par* file. Finally, the directory «e2eBoxes» is automatically created when the simulation runs.

1.2. Data

This directory contains some results obtained with this package :

- The *40mLock.dat/dhr* and the *Long40mLock.dat* data files are simulations in the time domain obtained with « modeler » showing how the in-lock state is reached : the first file shows a simulation of 6ms and the second one another one of ~1s. The laser power is 1W and the radiation pressure acts on the arms mirrors. The file *40mLock.in* has to be used to repeat the simulation. The *40mLock.dhr* contains the names of all the output channels.
- The *OptResp.dat* data file is the simulation of the optical response of the dual recycled interferometer. The file *OptResp.in* has to be used to repeat the simulation. The *OptResp.dhr* contains the names of all the output channels.
- The *OL40m_DARM_RadPr_50_g25.dat* data file is the simulation of the open loop transfer functions of the dual recycled interferometer with radiation pressure and the *OL40m_DARM_NoRadPr_50_g25.dat* data file without radiation pressure. The file *OLtf_DARM.in* has to be used to repeat the simulation. The file *OL40m_DARM_RadPr_50_g25.dhr* and the file *OL40m_DARM_NoRadPr_50_g25.dhr* contain the names of all the output channels with and without radiation pressure respectively.

1.3. Figures

This directory contains some figures corresponding to the described data files :

- The file *40mInLockState.jpg* corresponds to Figure (4) and shows the power for all the cavities: the two arms (XARM and YARM), the Michelson (MICH), the power recycling cavity (PRC) and the signal recycling cavity (SRC).

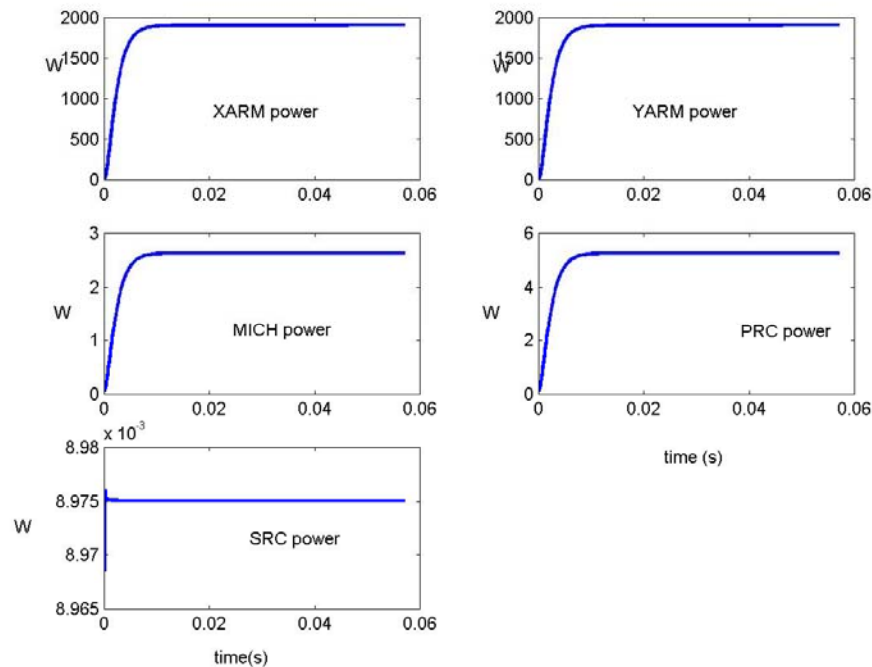

Figure 4 : 40m In-lock State for the arms cavities (XARM and YARM), Michelson cavity (MICH), power recycling cavity (PRC) and signal recycling cavity (SRC)

- The file *40mLock.eps* corresponds to Figure (5) and shows the error signals for the 5 degrees of freedom (DARM, CARM, MICH, PRCL and SRCL) going to zero when the interferometer is locked. The other channels can be plotted referring to the *40mLock.dhr* file where all the outputs are listed.

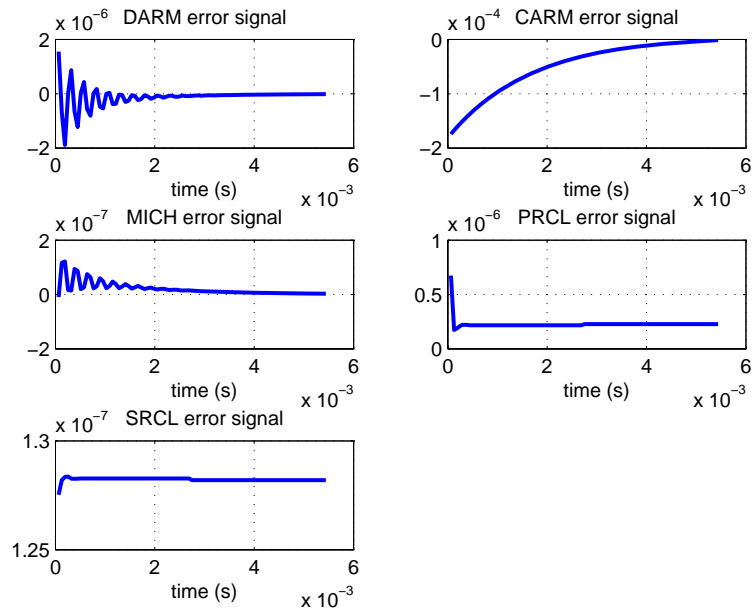

Figure 5 Error signals of the 40m IFO at in-lock state

- The *OptResp.eps* figure (Fig. 6) shows the optical response of the 40m IFO obtained using the data file *OptResp.dat/.dhr*. The file *OSfreq.in* has to be used to repeat the simulation.

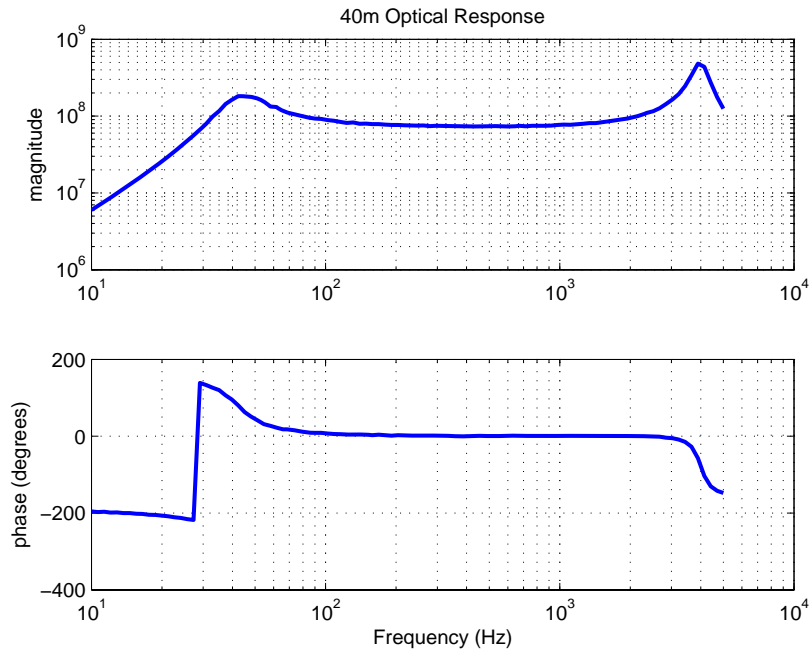

Figure 6 : 40m Optical Response: optical spring peak at 4Hz and RSE peak at 4kHz

- The *OL_DARM.eps* figure (Fig. 7) shows the open loop transfer function of the DARM degree of freedom with and without radiation pressure; it is obtained with the data file *OL40m_DARM_NoRadPr_50_g25.dat/.dhr* where no radiation pressure is included and the data file *OL40m_DARM_RadPr_50_g25.dat/.dhr* including the radiation pressure on both ITMs and ETMs mirrors. The file *OLtf_DARM.in* has to be used to repeat the simulation.

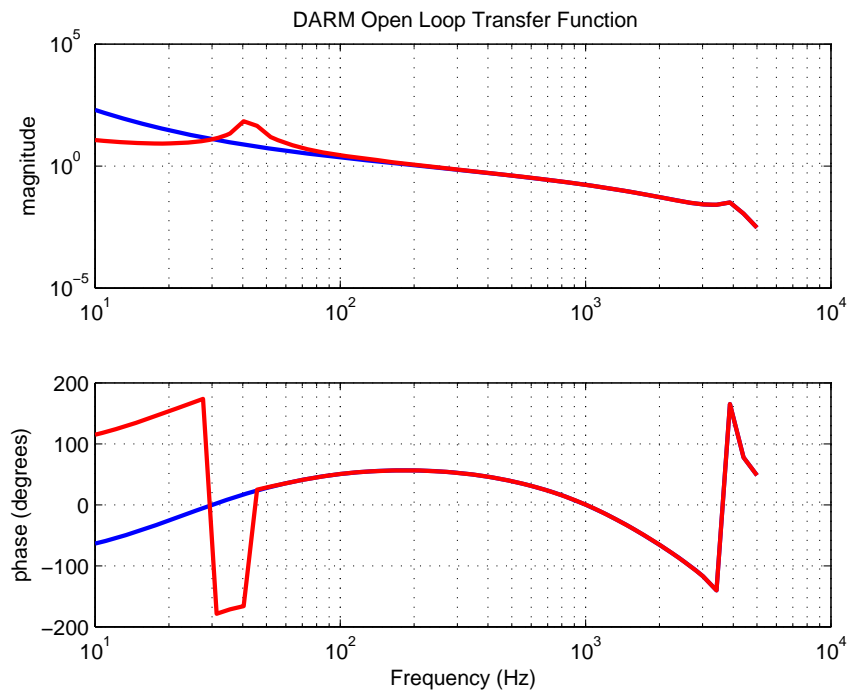

Figure 7 : DARM open loop transfer function

2. How to use the existing data

To plot the time series data obtained with *modeler* one has to refer to the *40mLock.dat* file and the *40mLock.dhr* file where all the output channels are listed.

In order to plot the *40mLock.dat* file in MATLAB type the following

```
e2edataTime = load('40mLock.dat');
plot(e2edataTime(:,1),e2edataTime(:,2))
```

changing the output according to the channel you want to see.

To plot the data file obtained with *modeler_freq* one has to refer to the *OptResp.dat* and the *OptResp.dhr* files where all the output channels are listed. The transfer function from the displacement to the error signal is obtained with the ratio of the two output calculated by *modeler_freq*.

To plot the data file *OptResp.dat* for instance in MATLAB type the command line

```
e2edataFreq = load('OptResp.dat');
subplot(2,1,1),loglog(e2edataFreq(:,1),e2edataFreq(:,4)./e2edataFreq(:,2))
subplot(2,1,2),semilogx(e2edataFreq(:,1),(e2edataFreq(:,5)-e2edataFreq(:,3))*180/pi)
```

where the channels are defined in the *OptResp.dhr* file. The *OpticalResponse.jpg* figure shows the optical response.

3. How to run the package

This paragraph describes how to run a simulation with *modeler* in the time domain and with *modeler_freq* in the frequency domain.

- To run the simulation of the lock acquisition with *modeler* the *40mLock.in* and *40mLockSeismic.par* files are needed, then one can type this command line

```
cat 40mLock.in -| modeler -viewerOFF -thread -bin
```

- To run the simulation of the optical response of the cavity with *modeler_freq* the *OptResp.in* and the *40mLockNoSeismic.par* files are needed, then type this command line

```
cat OptResp.in -| modeler_freq -viewerOFF -thread -bin
```

References

- e2e website : <http://www.ligo.caltech.edu/~e2e/>
- the package location is on the e2e website <http://www.ligo.caltech.edu/~e2e/> in the section Examples.