

LASER INTERFEROMETER GRAVITATIONAL WAVE OBSERVATORY
- LIGO -

CALIFORNIA INSTITUTE OF TECHNOLOGY
MASSACHUSETTS INSTITUTE OF TECHNOLOGY

Document Type LIGO-T960142-00 - CPD 8/20/96
CDS Control and Monitoring Preliminary Design
R. Bork

Distribution of this draft:

This is an internal working note
of the LIGO Project.

California Institute of Technology
LIGO Project - MS 51-33
Pasadena CA 91125
Phone (818) 395-2129
Fax (818) 304-9834
E-mail: info@ligo.caltech.edu

Massachusetts Institute of Technology
LIGO Project - MS 20B-145
Cambridge, MA 01239
Phone (617) 253-4824
Fax (617) 253-7014
E-mail: info@ligo.mit.edu

WWW: <http://www.ligo.caltech.edu/>

1 Introduction	4
1.1. Purpose	4
1.2. Scope	4
1.3. Document Overview	4
1.4. Definitions	6
1.4.1. Front End Systems.	6
1.4.2. VME.	6
1.4.3. Real-Time Software.	6
1.4.4. Non-Real-Time Software.	6
1.5. Acronyms	6
1.6. Applicable Documents	7
2 System Overview	8
3 Front End Systems	9
3.1. Front End I/O Bus	9
3.2. Real-time Control Processor	9
3.2.1. Hardware	9
3.2.1.1 General Purpose Real-time Processor	9
3.2.1.2 Digital Signal Processor	10
3.2.2. Software	10
3.2.2.1 General Purpose Processor Software	10
3.2.2.1.1 Overview	10
3.2.2.1.2 Operating System	11
3.2.2.1.3 Control Kernel	11
3.2.2.1.3.1 Design	11
3.2.2.1.3.2 Planned Use of EPICS	12
3.2.2.1.4 Development Tools	12
3.2.2.2 DSP Software	14
3.2.2.2.1 Development Tools	14
3.2.2.2.2 Operating System	14
3.3. Analog Servo and Signal Conditioning Hardware	14
3.4. Equipment Housing	16
3.4.1. Design Specifications	16
3.4.2. Typical Layout	16
3.5. Inter-connection wiring	17
3.6. Interfaces	19
3.6.1. Rack Placement	19
3.6.2. Rack Assignments and Layouts	19
3.6.3. Cable Raceways	19
3.6.4. Cable in Vacuum	20
3.6.5. Rack infrastructure cabling	20

3.6.6. Facility Power	20
4 Timing System	21
4.1. Design	21
4.2. Interfaces	21
5 Communications	23
5.1. Networking	23
5.1.1. CDS Control and Monitoring Network (CMN)	23
5.1.2. DAQS Network	25
5.1.3. CDS Real-Time Network (RTN)	25
5.2. Phone Service	25
5.3. Communications Cable Plant	25
6 Operations Support	27
6.1. Facility Control Room	27
6.2. Operator Stations	27
6.2.1. FCR Consoles	27
6.2.2. Fixed/Portable Workstations	28
6.2.3. Portable Laptop Stations	28
6.2.4. Remote Access	28
6.3. Computer/Mass Storage Area	28
6.3.1. Control and Monitoring Server	28
6.3.2. Uninterruptable Power Supplies (UPS)	29
6.4. Software	29
6.4.1. Operating Systems	30
6.4.2. Compilers	30
6.4.3. Communications	30
6.4.4. Human-Machine Interface	30
6.4.4.1 General Controls	30
6.4.4.2 Additional HMI	30
6.4.5. Data Archival and Retrieval	31
6.4.5.1 Data Archival	32
6.4.5.2 Archive Data Retrieval	32
6.4.6. Alarm Management	33
6.4.7. Save and Restore	33
6.4.8. System Diagnostics	33
6.4.9. Application Programmer's Interface	34
Appendix A Control and Monitoring DRR Action Items	35
Appendix B CDS Rack Location Drawings.....	37
Appendix C CDS Rack Layout Drawings.....	38

Appendix D CDS Networking 39

Appendix E CDS Software 40

1 INTRODUCTION

1.1. Purpose

The purpose of this document is to describe the design and standards to be incorporated in the infrastructure for CDS control and monitoring systems.

1.2. Scope

CDS for LIGO has been divided, for design purposes, into three major components: Control and Monitoring, Data Acquisition and Interferometer Diagnostics. The Data Acquisition system is described in other documentation, namely the requirements in LIGO T960009-C and conceptual design in LIGO T960010-C. The IFO Diagnostics are defined in LIGO T960107-C and LIGO T960108-C.

This document describes a preliminary design for the infrastructure to be employed in the LIGO control and monitoring system, which includes:

- LIGO control room systems, including operator consoles.
- Computer networking systems
- Timing systems to accurately timestamp LIGO data, both for control and monitoring and for LIGO data acquisition.
- Standard Input/Output (I/O) systems to be used to interface to equipment to be controlled/monitored (referred to, within this document, as front end systems).
- High level control and monitoring application and development software.

This is the highest level of CDS control and monitoring design documents, a direct outcome of the CDS Control and Monitoring Requirements Document (LIGO T950054-C), as shown in Figure 1: LIGO Requirement Specification Tree. Other CDS design documents cover specific hardware and software implementations applied to the various LIGO interferometer, vacuum and physics environment control subsystems.

1.3. Document Overview

This document represents the preliminary design for the LIGO control and monitoring system infrastructure and basic standards which will be incorporated in all LIGO control subsystem designs. This document is essentially an update to the Control and Monitoring Conceptual Design, LIGO T950120-C, incorporating additional design details and updates and responses to action items outlined in the CDS Control and Monitoring DRR Review Report LIGO E960026-D (Excerpt attached as Appendix A to this document). This document is to be reviewed as part of the CDS Preliminary Design Review, and, once reviewed and revised, will become the basis for the final design and installation documentation and drawings.

This document details a design which depicts what would be installed in the system if the system were to be deployed in the near term with today's technology. Since CDS involves a large amount of computer and related equipment, it is anticipated that these technologies will advance over the next two years before major purchases are made. Therefore, specific equipment selections shown in this document will change over the design phase, but the general concepts should still be valid.

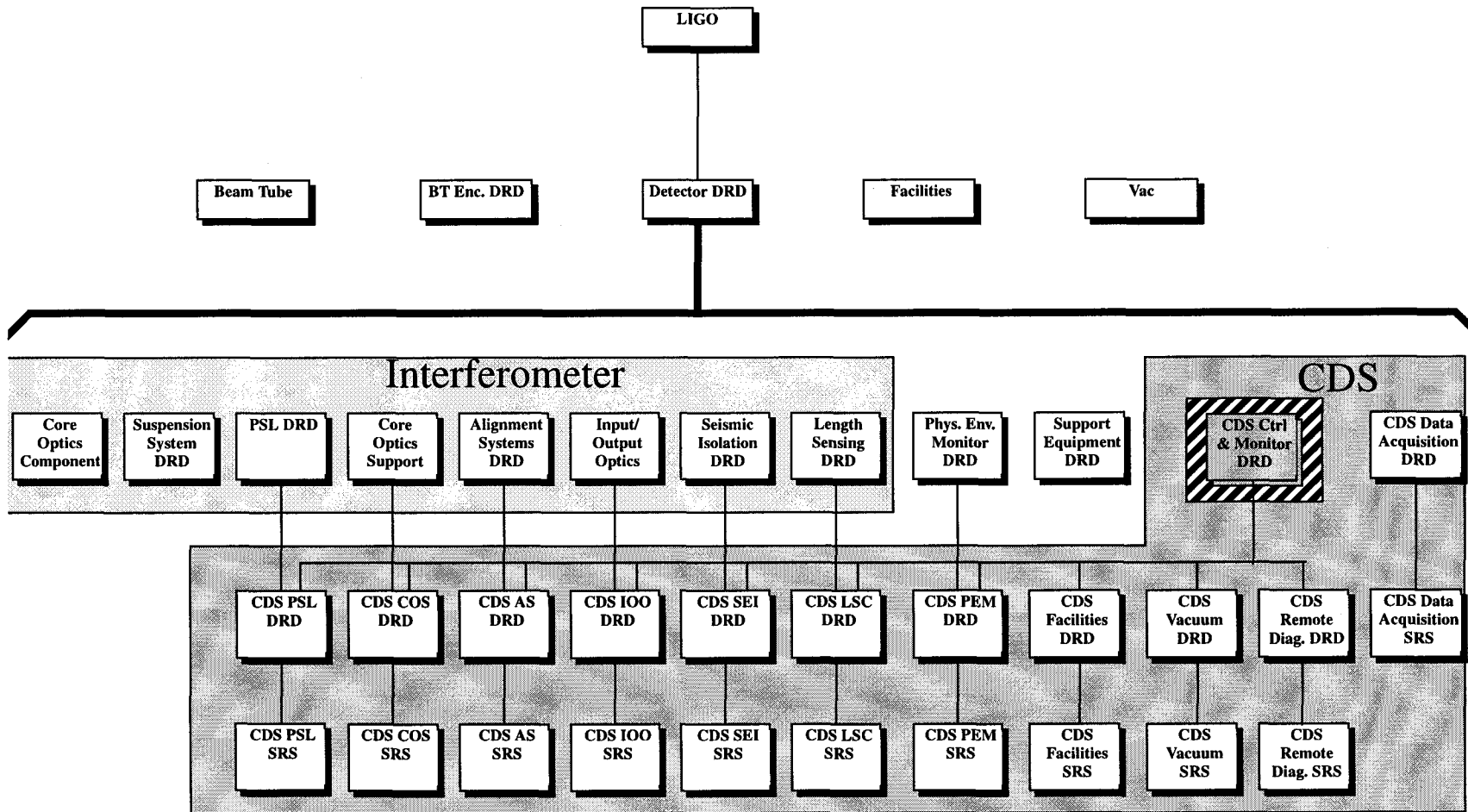

Figure 1: LIGO Requirement Specification Tree

1.4. Definitions

1.4.1. Front End Systems.

A Front End System is that part of a distributed system which interfaces with the signals to be measured. It is typically a real-time, crate based system, with direct electrical connections to the detector hardware.

1.4.2. VME.

Versa Module Eurocard, a bus based crate system allowing card based modules to communicate with each other via an arbitrated bus. Most LIGO front end systems are based on VME systems.

1.4.3. Real-Time Software.

Real-time software is that software which is deterministic in its task scheduling and duration. Throughout this document, this term refers to software which runs on a VME micro-processor under control of a real-time operating system (VxWorks).

1.4.4. Non-Real-Time Software.

Non-real-time software refers, in this document, typically to that software which runs under the UNIX operating system. This is due to the non-deterministic scheduling and task duration under this operating system.

1.5. Acronyms

- ALH - EPICS Alarm Manager
- API - Application Programmer's Interface
- APS - Advanced Photon Source (Argonne National Lab)
- AR - EPICS data archiver
- ARR - EPICS archive retrieval tool
- ATM - Asynchronous Transfer Mode
- BURT - BackUp and Restore Tool
- CA - Channel Access
- CDS - Control and Data System
- CPU - Central Processing Unit
- DCS - Distributed Control System
- DRD - Design Requirements Document
- DSP - Digital Signal Processor
- EPICS - Experimental Physics and Industrial Control System
- EZCA - Easy Channel Access
- FCMS - Facility Control and Monitoring System
- FCR - Facility Control Room
- GPS - Global Positioning System
- GUI - Graphical User Interface
- HMI - Human Machine Interface
- HPPI - High Performance Parallel Interface

- Hz - Hertz
- IEEE - Institute of Electronic and Electrical Engineering
- IFO - Interferometer
- I/O - Input/Output
- IP - Internet Protocol
- ISO - International Standards Organization
- IXS - Information eXchange Services
- LAN - Local Area Network
- LANL - Los Alamos National Laboratory
- LIGO - Laser Interferometer Gravity wave Observatory
- LVEA - Laser and Vacuum Equipment Area
- MHz - Mega Hertz
- OSB - Operations Support Building
- PDD - Preliminary Design Document
- PSL - PreStabilized Laser
- TBD - To Be Determined
- TCP - Transport Control Protocol
- UPS - Uninterruptable Power Supplies
- VAC - Volts Alternating Current
- VDC - Volts Direct Current
- VME - Versa Modular Eurocard
- VXI - VME eXtensions for Instrumentation

1.6. Applicable Documents

CDS Control and Monitoring DRD LIGO T950054-C

CDS Control and Monitoring Conceptual Design LIGO T950120-C

CDS Control and Monitoring DRR Report LIGO E960026-D

CDS Data Acquisition System DRD LIGO T960009-C

CDS Data Acquisition System Conceptual Design LIGO T960010-C

CDS Interferometer Diagnostics DRD LIGO T960107-C

CDS Interferometer Diagnostics Conceptual Design LIGO T960108-C

CDS Vacuum Cabling and Feed Through DRD LIGO T950095-C

2 SYSTEM OVERVIEW

The control and monitoring systems of CDS are designed as a Distributed Control System (DCS). A basic block diagram of the hardware arrangement is shown in Figure 2: CDS Overview. The major components are:

- Operational Support: Operator stations and supporting compute and disk servers which provide:
 - Human-Machine Interfaces (HMI)
 - Control application software storage and computer boot services
 - Data archival
- Data Communications: The data networking facilities necessary for inter-processor communications.
- Timing System: Time of day and data strobing facilities
- Front End Systems: Interfaces to and real-time control of LIGO equipment

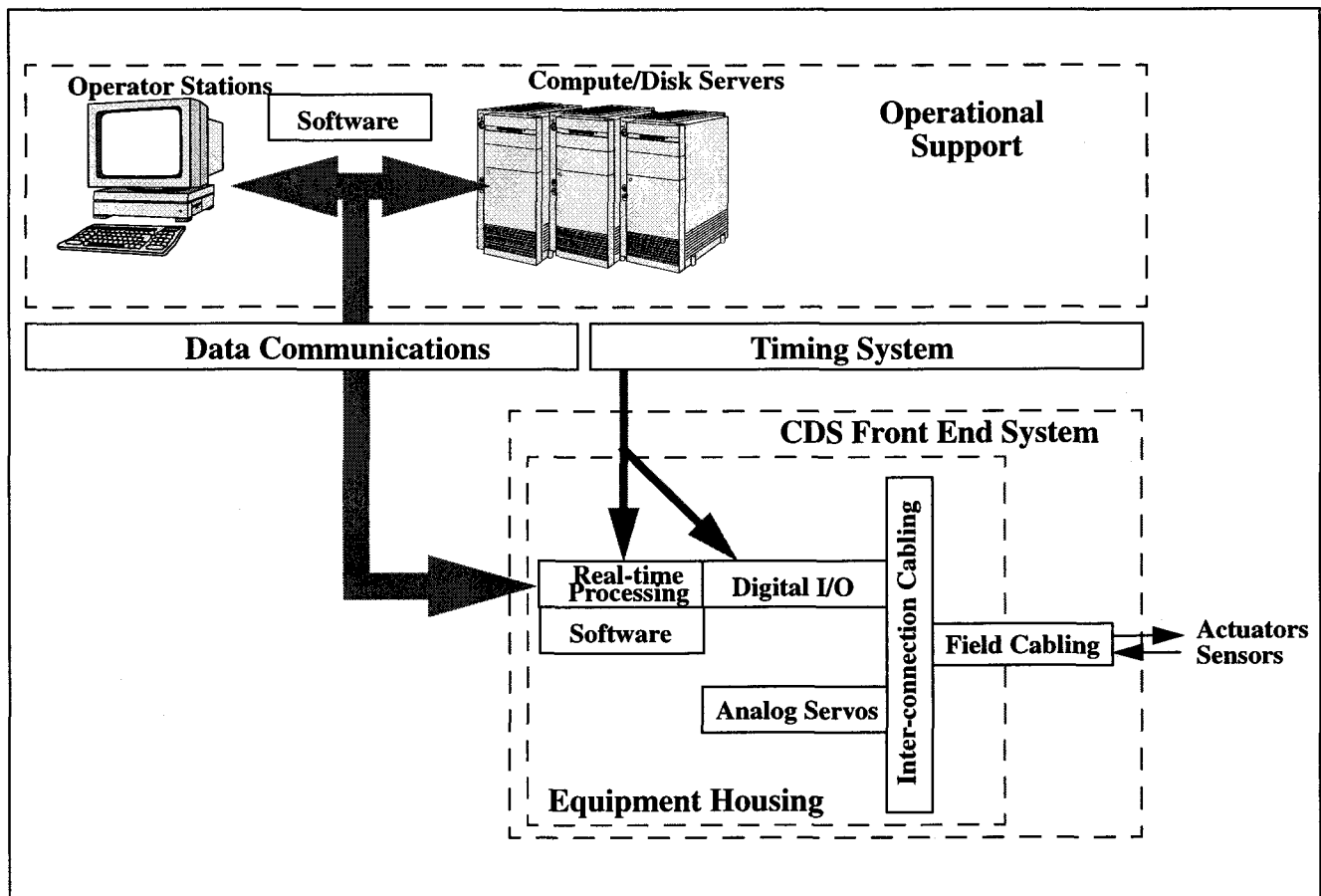

Figure 2: CDS Overview

3 FRONT END SYSTEMS

Front end systems are the field units which connect the CDS to the equipment to be controlled and/or monitored and provide for the real-time control of that equipment. The following sections describe the standard equipment to be employed in these systems.

3.1. Front End I/O Bus

The CDS will employ Versa Modular Eurocard (VME) standard crates and modules for front end I/O and processing. The VME crates meet LIGO CDS standard TBD. VME eXtensions for Instrumentation (VXI) systems may also be used in limited applications.

Any number of I/O and/or processor busses are available today which would meet LIGO needs. Some of the reasons VME is chosen over other buses are:

1. Commercial standard, with support from numerous vendors.
2. Relatively high performance / low cost.
3. Open standard architecture allowing for custom module designs.
4. High versatility. Many VME based products available, from standard I/O, to processors, to DSP modules, which allows a great flexibility for CDS design and future upgrades.

3.2. Real-time Control Processor

3.2.1. Hardware

Real-time processors fall into two categories:

- General Purpose: Provides for the bulk of real-time processing and handling of network communications.
- Digital Signal Processor (DSP): Specialized processor used to perform advanced signal processing for specific applications.

3.2.1.1 General Purpose Real-time Processor

While processor technology will have advanced prior to LIGO CDS installation, the present choice of a VME processor is a unit based on the MIPS4700. By the end of 1996, a MIPS5000 board should be available. All prototype developments are presently using this processor series. Selected specifications on these processor boards are:

- Single width VME module
- IDT R4700 processor, true 64 bit, operating at 133MHz
- Performance: 87MFLOPS/sec, 120SPECint92, 90SPECfp92
- 16MBytes RAM
- VME64 with board to board transfer rates to 60MByte/sec
- Two PCI Mezzanine Card (PMC) interfaces
- Two serial and one ethernet (or fast ethernet) interface

3.2.1.2 Digital Signal Processor

During the design phase of individual IFO subsystems, some emphasis will be put on moving from present analog servo designs, used in previous R&D and prototype activities, to full digital implementations. For this purpose, Digital Signal Processors (DSP) may be used, if the general purpose processor cannot meet requirements and a DSP solution can meet those requirements. In those cases, a VME based DSP module would be employed, typically as a stand-alone servo controller which looks, to the general purpose processor, as a co-processor and/or standard VME module. The choice of DSP modules is TBD pending analysis of subsystem requirements.

3.2.2. Software

A block diagram of CDS control and monitoring software is shown in Figure 1 of Appendix E. For real-time control, the key components are:

- **Real-time Processor Development Tools:** Set of software tools for developing real-time databases and application software.
- **Real-time Executables:** The actual operating system and application software which is executed in runtime on the general purpose processors for control and monitoring.
- **DSP Development Tools:** Toolkit for modelling and implementing DSP applications.
- **DSP Executables:** Operating system and application software which runs on the DSP.

3.2.2.1 General Purpose Processor Software

3.2.2.1.1 Overview

Figure 3: Real-time Software Overview depicts the primary components for the CDS real-time software development and execution. This environment will be used for all processor systems performing real-time control, which includes all processors in front end systems.

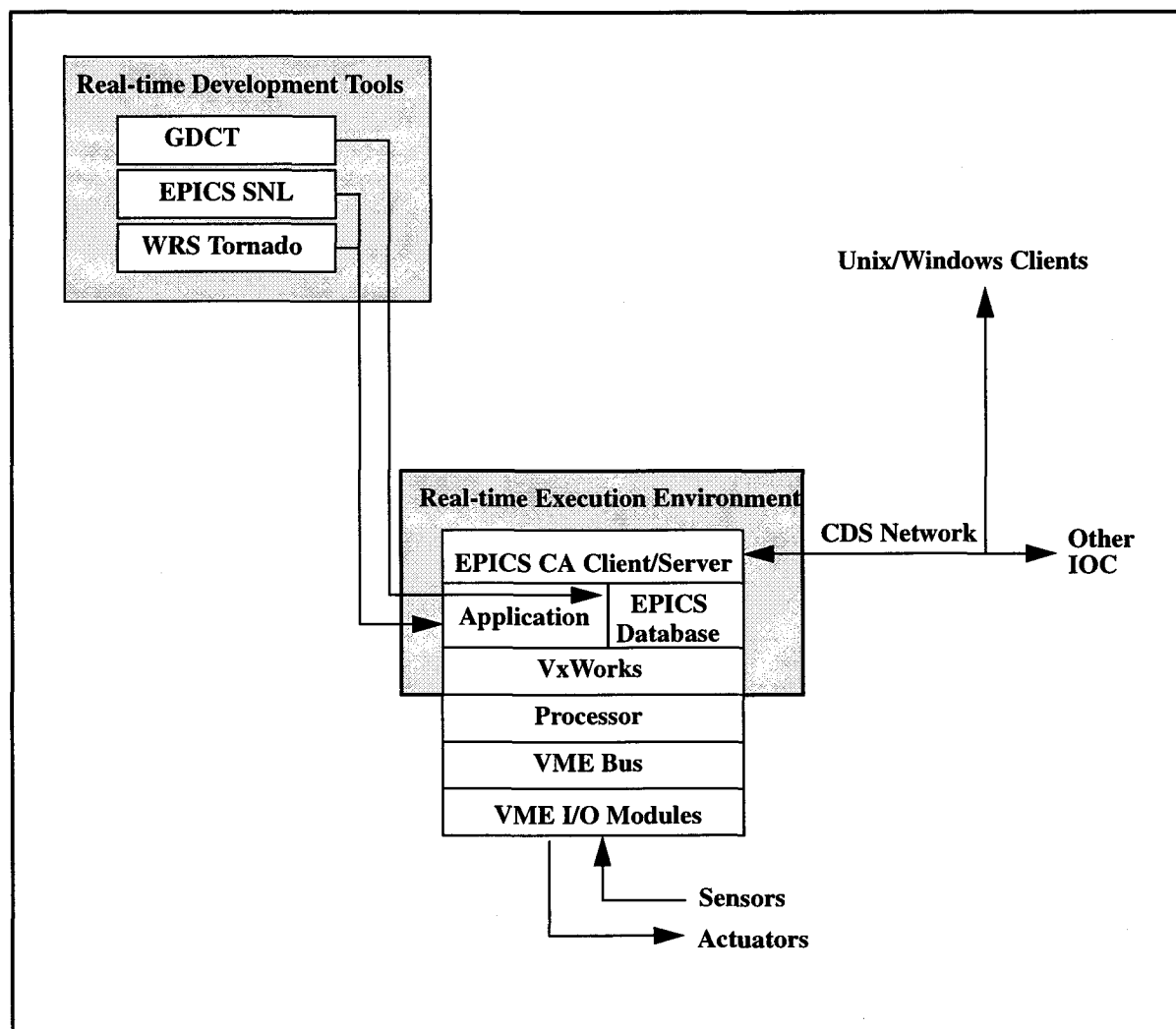

Figure 3: Real-time Software Overview

3.2.2.1.2 Operating System

The real-time operating system to be used is VxWorks from Wind River Systems. Cross-compilers and development tools from the latest version (presently the Tornado product (VxWorks 5.3)) will be used to develop and compile CDS real-time applications.

3.2.2.1.3 Control Kernel

3.2.2.1.3.1 Design

The control kernel on which real-time applications operate and/or communicate through is EPICS. EPICS provides:

1. A real-time database mechanism and associated development tools.

2. Drivers to interface a number of VME, VXI and PLC I/O modules.
3. Networking interfaces through its Channel Access modules, which allows interconnection between various real-time processors and Unix workstations via ethernet or any media providing TCP/IP.
4. A State Notation Language (SNL) to build sequencing software and/or connect custom C code to the real-time database.
5. Timestamping of data to 1usec accuracy. EPICS has been modified for LIGO to use the GPS VME modules as the time source. (Base EPICS uses time services from one processor (master) across ethernet to all other real-time processors.)

EPICS consists of two primary parts, the core and extensions. Here the core is defined as the real-time components which provide the functions listed in the previous section. Extensions are typically Unix components, such as the HMI, described later.

The EPICS core is chosen as the control kernel for the following reasons:

1. Supported by a collaboration of labs and universities, primarily LANL, APS and CEBAF. The core has not changed notably over past year or so and has been fairly robust, as indicated by the success and popularity of the system.
2. Channel Access. This is a discovery protocol, which allows automatic lookup and connection to data residing anywhere on the network in any processor through the use of a unique name tag given each signal.
3. API. Channel access and real-time database calls are available for inclusion into custom software, allowing easy addition of new code and allowing code to make use of the EPICS core infrastructure.
4. Open system. This allows code to be added, as necessary, to meet particular LIGO needs.

3.2.2.1.3.2 *Planned Use of EPICS*

The key role foreseen for EPICS is to provide what is called, in industrial control environments, the Supervisory Control And Data Acquisition (SCADA) functions for the LIGO CDS. This is predominantly the network communications and HMI. Only slow operations, such as remote push-button functions, will solely use the EPICS database for control. The bulk of CDS software for control will be developed as C code, using EPICS SNL to communicate to the EPICS database within a processor and EPICS channel access to communicate between processors. This is the method that was employed successfully on the LIGO PSL prototype. A block diagram of that software is shown in Figure 4: PSL Prototype Control Software.

3.2.2.1.4 *Development Tools*

The software development tools to be used are shown in the upper left corner of Figure 3: Real-time Software Overview. The Tornado product (VxWorks 5.3) from Wind River Systems will be used for C/C++ code development. (Note: No support will be provided for Fortran on real-time processors).

For connection of CDS C/C++ software to the real-time EPICS database, the EPICS SNL code and pre-compiler will be used. This provides for standard calls to send/retrieve data to/from EPICS, as well as obtain monitors and events from EPICS.

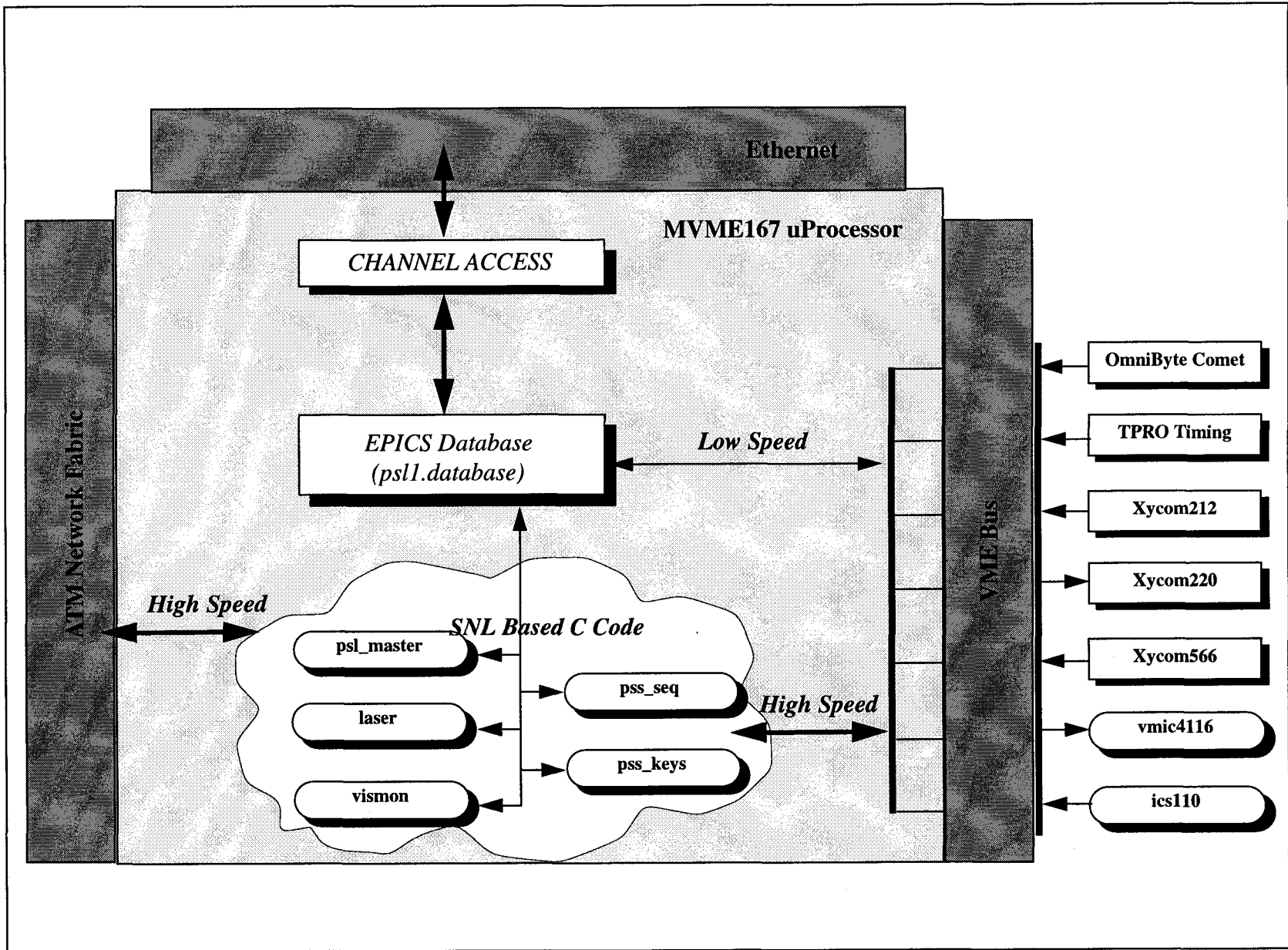

Figure 4: PSL Prototype Control Software

To develop EPICS databases, the EPICS Graphical Database Configuration Tool (GDCT) is to be the primary tool. Example windows from GDCT are shown in Figure 2 of Appendix E. This tool allows development of a database and control flow by a method similar to electronic CAD software. In this case, the "parts" are functional software blocks, which have associated both pre-defined algorithms and user-defined data.

One of the weaknesses of GDCT is that it does not contain database report generation tools. Therefore, an interface has been made to Microsoft Access, which allows information to be extracted from GDCT into Access database tables. This allows the many sorting and reporting capabilities of a relational database to be employed.

3.2.2.2 DSP Software

3.2.2.2.1 Development Tools

For the development of DSP applications, the SPW product line from AltaGroup will be used. This is a high end DSP modelling and implementation environment which is an extension of the Cadence software used by the CDS group to develop electronic hardware designs.

3.2.2.2.2 Operating System

To provide communication with VxWorks, running on the general purpose processors, both in runtime and to download code to the DSP across the network, the SPOX operating system will be used. This is a commercial standard operating system which supports virtually all DSPs on the market.

3.3. Analog Servo and Signal Conditioning Hardware

Analog servo and signal conditioning units will be designed and manufactured as 6U Eurocards. These will be installed into LIGO standard Eurocard cages similar to the LIGO VME crates. However, the backplanes for these crates will only provide power connections, not digital lines. Such a crate is shown in Figure 5: CDS Eurocard Cage.

This housing has the same appearance as the CDS VME crates. However, as seen from the top view, two backplanes are installed, allowing modules to be inserted in both the front and back of the unit. Sensitive analog circuit boards would be installed in the front, with modules containing high voltage and power circuitry installed into the rear slots. Space is provided in the center between the backplanes to allow access for interface cabling.

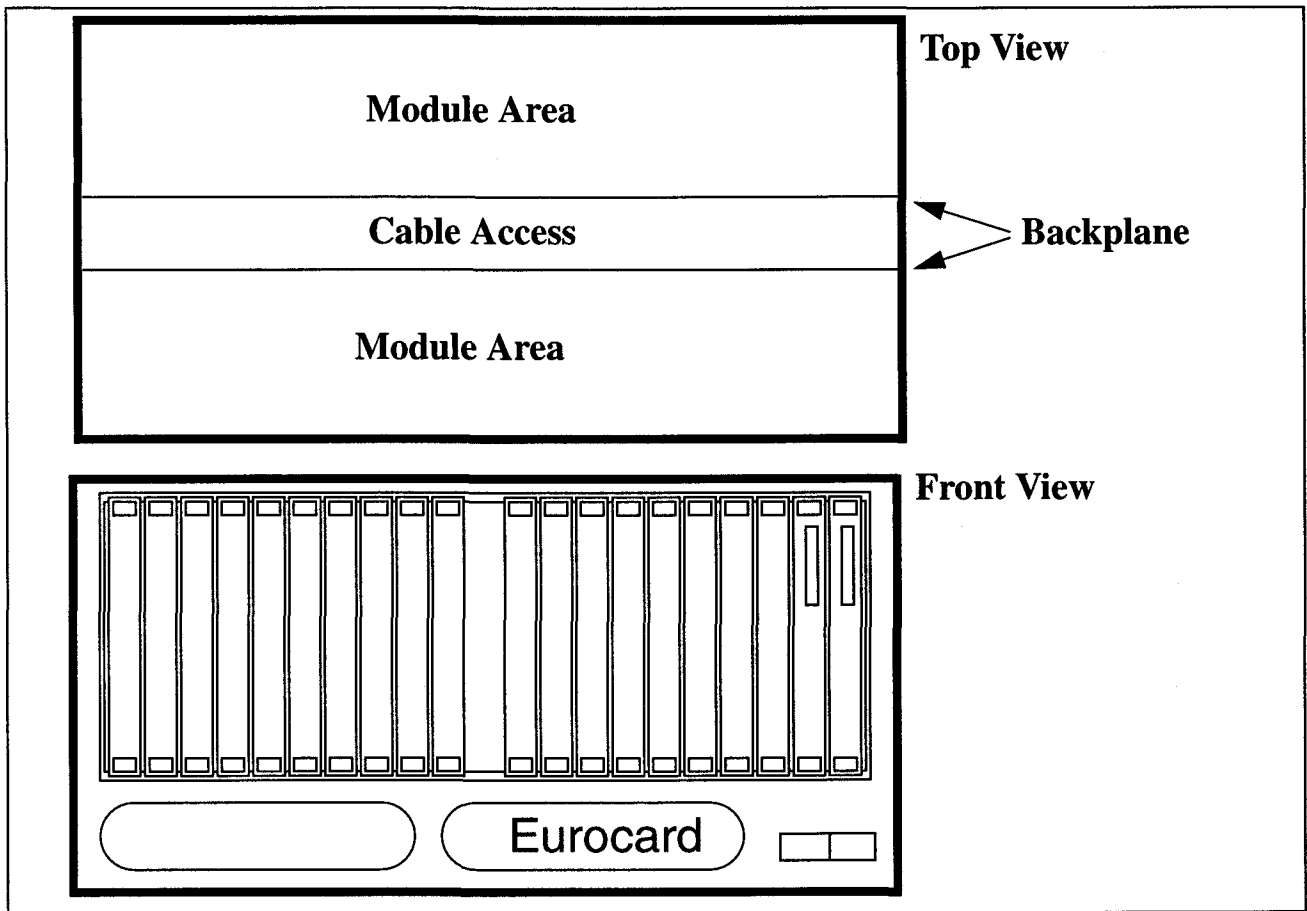

Figure 5: CDS Eurocard Cage

3.4. Equipment Housing

3.4.1. Design Specifications

CDS front end systems will be contained in standard 19" rack mounting systems. The standard rack and specifications are shown in Figure 6: CDS Rack Standard.

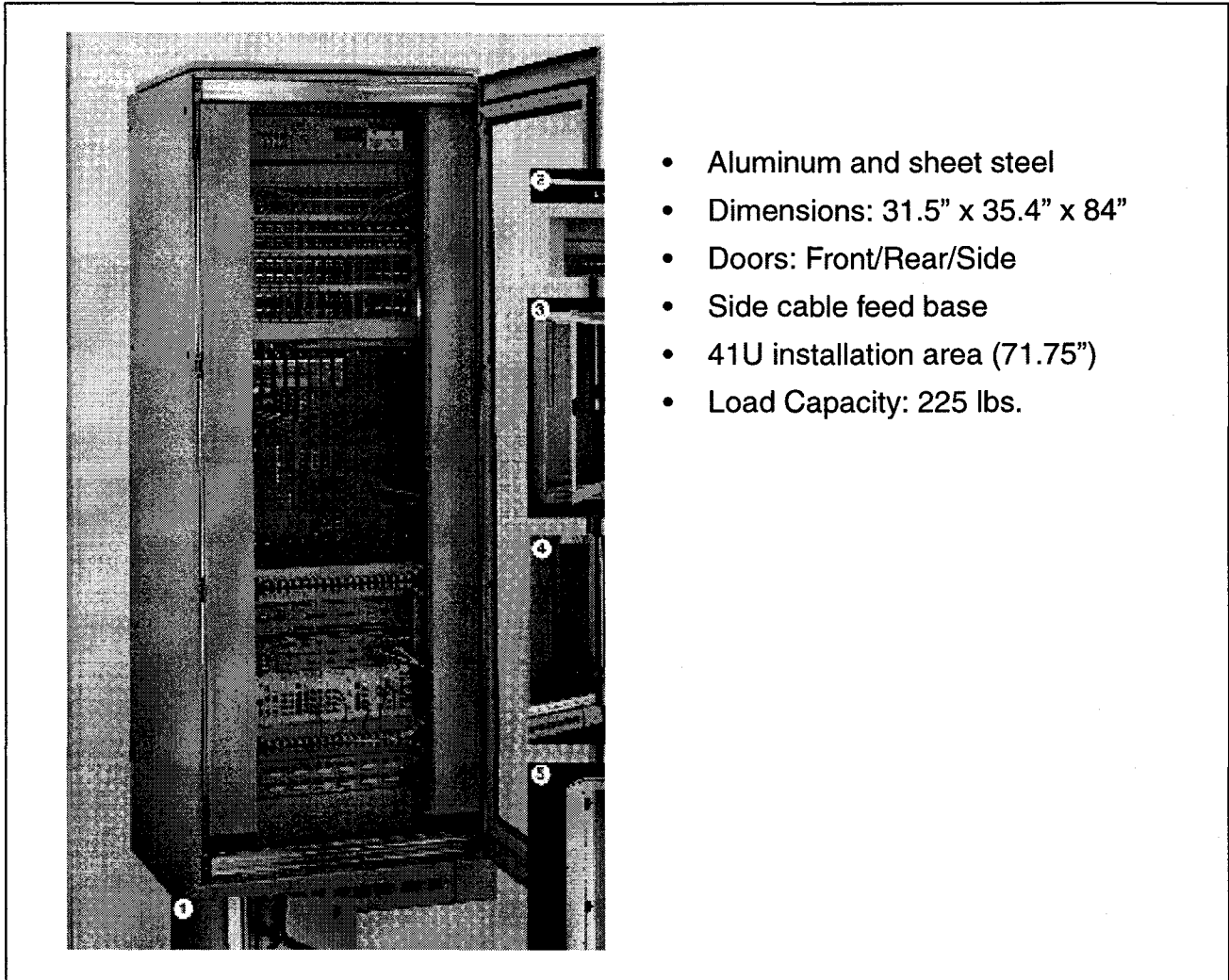

Figure 6: CDS Rack Standard

3.4.2. Typical Layout

A typical front end rack layout for interferometer control subsystems is shown in Figure 7: CDS Standard Front End Rack Assembly (LVEA). This rack contains:

1. A 1U top panel (Service Panel), which includes:
 - Panel breaker(s) for rack power
 - 10baseT connector which provides an ethernet connection to the CDS networks. This allows for connection of a laptop PC for local operation/maintenance.

- Phone jack
- 2. Two 1U 24VDC power supplies. +/-24VDC will be the CDS standard for binary I/O operation, such as relays, switches, contacts, etc. These are also the standard supplies for CDS analog servo circuit boards.
- 3. VME and Eurocard crates
- 4. Wiring cross connect systems
- 5. Phone

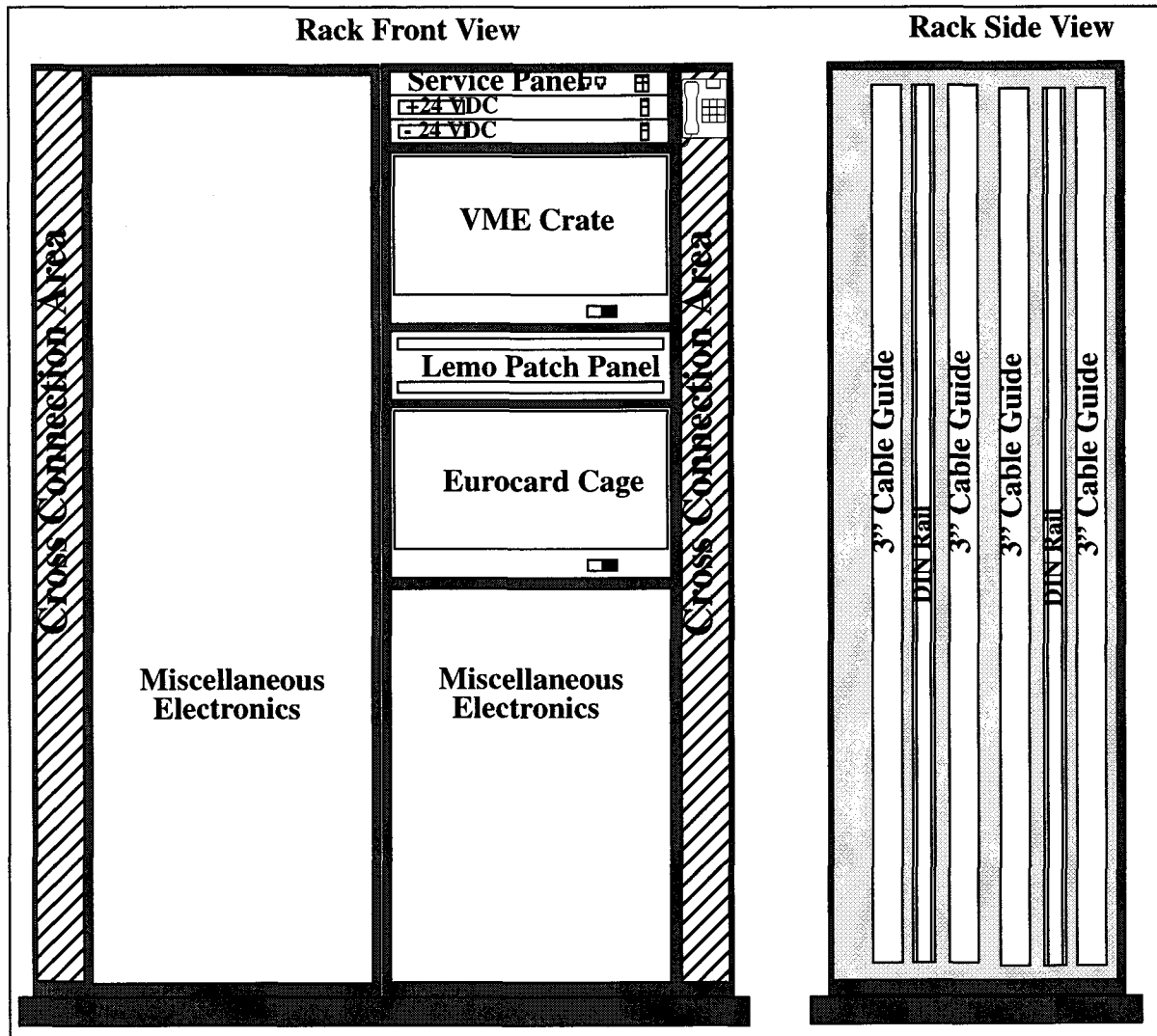

Figure 7: CDS Standard Front End Rack Assembly (LVEA)

3.5. Inter-connection wiring

Three general schemes will be used to interconnect CDS modules and CDS to external equipment:

1. Coax wiring through a Lemo patch panel.
2. Interconnect wiring through DIN rail mounted discreet or mass termination blocks.

3. Signal cables designated as “critical” due to signal levels, noise levels, allowed lengths, etc., will be run directly from the CDS interface module(s) to the equipment involved.

As shown in the previous rack layout sketch, a Lemo patch panel will exist between the control and monitoring and DAQ crates. This will be the primary interface point to control signals which must be acquired and archived by the DAQ system. This panel will also provide the connection point for signals interfaced via coaxial cable to field equipment and provide some standard test point signals for o’scope connection.

As can be seen in Figures 4 and 5, the CDS racks are oversized in width and generally installed in pairs. This allows field cabling to enter from the bottom sides of racks and terminate into side mounted DIN equipment. This method is shown in Figure 8: CDS Cable Interconnect System. This cross connect area contains alternating 3” cable guide and DIN rails. The DIN rails will be used to mount Phoenix (or equivalent) mass termination blocks for connection of multi-conductor ribbon cable from VME I/O modules to field devices and single point termination blocks for distribution of power and similar types of signals. The standard mass termination cable is a twisted, shielded, round ribbon type, with flat ribbon breakouts at 2 meter intervals for the standard ribbon connectors. The routing of cable from the VME and other front panel electronics to the cross connect area will be via punchouts in the 3” cable guide areas through the rack side wall into the main rack area.

Cable routing into/out of the racks will be via the bottom of the rack. In LIGO equipment buildings, cabling will be through a toe base into a floor-mounted cable tray. Those racks located within the control areas of the OSB will be via openings in the raised floors.

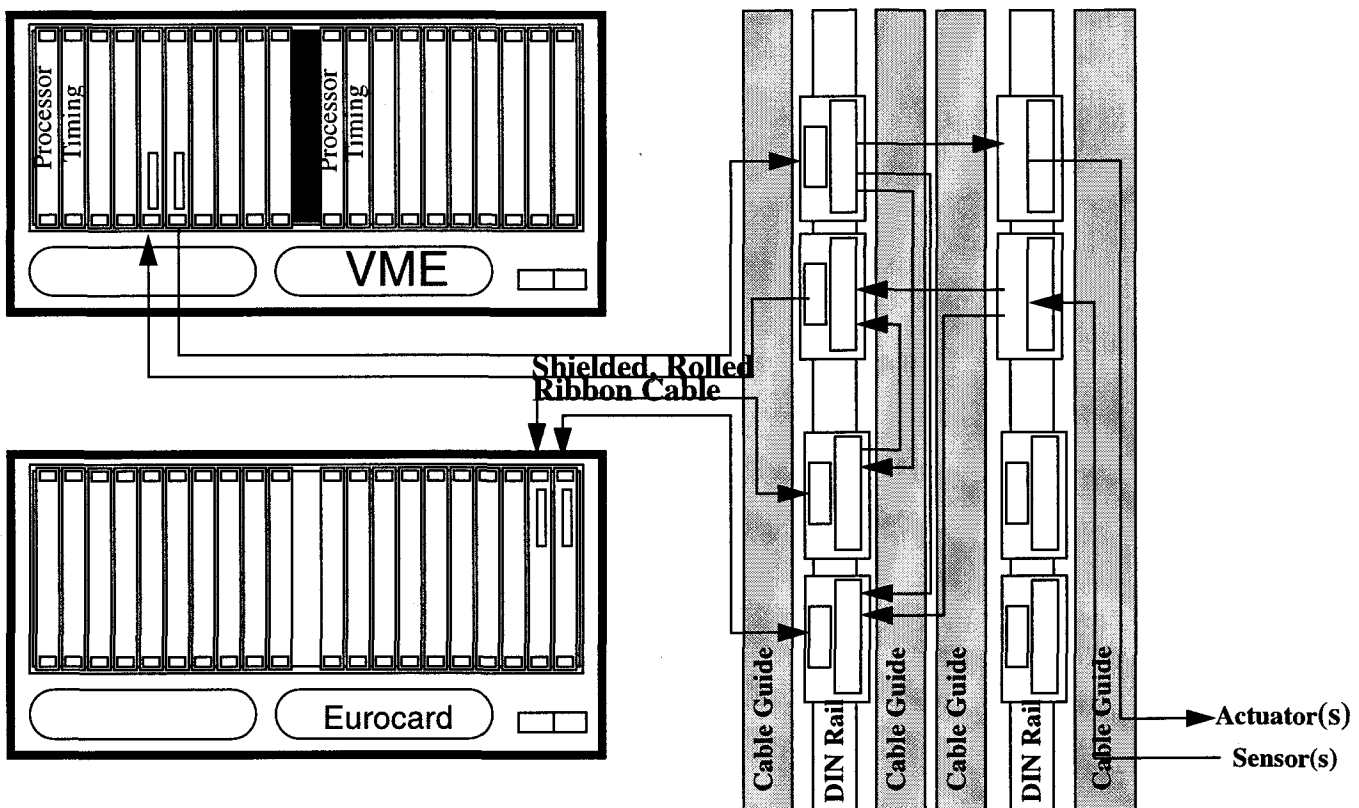

Figure 8: CDS Cable Interconnect System

3.6. Interfaces

The following figure shows the interfaces to CDS front end system racks. These are further described in the following subparagraphs.

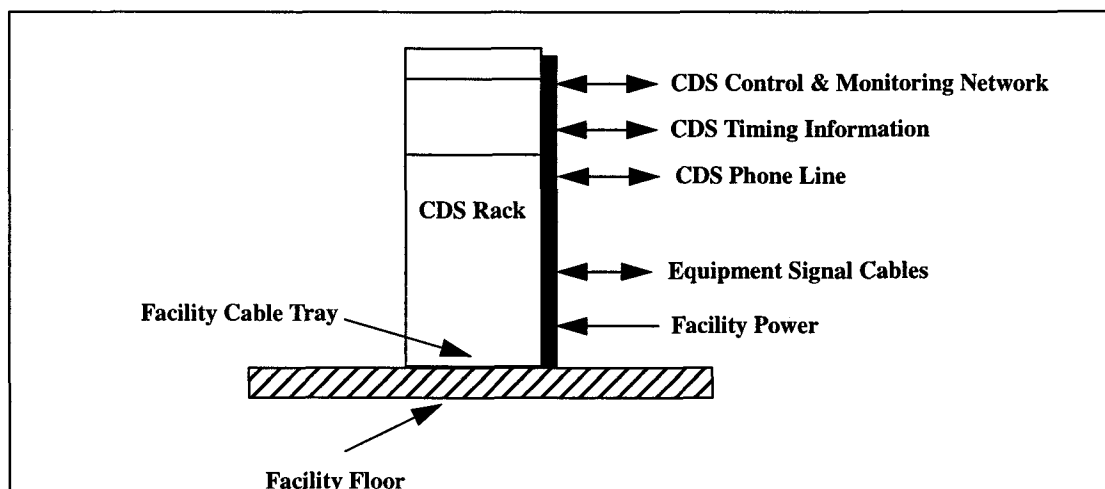

Figure 9: CDS Front End Rack Interfaces

3.6.1. Rack Placement

CDS rack placements for the LVEA and mid and end stations are depicted in LIGO D960073-E, Chamber and Rack Designations (Included in Appendix B). Rack placements for the corner station mechanical room and OSB computer/mass storage room are shown in Appendix C, figures 1 and 5 respectively.

3.6.2. Rack Assignments and Layouts

Preliminary rack assignments and layouts are shown in Appendix C, figures 1 through 5. These are intended only to estimate rack space requirements and connection points for networking and other control and monitoring infrastructure services. Detailed layouts will follow in CDS subsystem final designs.

The only rack assignments which are fixed at this time are those required for vacuum system controls. Those have been established as an interface with the vacuum equipment vendor. Other rack assignments are driven by trying to keep all IFO controls (less the output optics and dark port) in the area of the PSL (Racks 1X1 through 1X9 and 2X1 through 2X9). The intent is to try and limit the amount of territory early testing and commissioning personnel will need to cover when trying to install/check out systems.

3.6.3. Cable Raceways

Cable trays will be provided (by others) under the beam tubes for the routing of CDS cables. These trays will be subdivided into three parts to provide separation of cables by function:

- Analog signal cables
- Digital cables
- Power cables

Short tray stubs will be provided at each rack location to get from the main cable trays to entry at the rack bases.

3.6.4. Cable in Vacuum

CDS must provide certain cables into the LIGO vacuum chambers. All cabling within vacuum will meet the Vacuum Cabling and Feedthrough (VCF) requirements as outlined in LIGO T950095-C.

3.6.5. Rack infrastructure cabling

Infrastructure cabling includes those cables and functions which are to be provided to all CDS front end racks. The following table shows the infrastructure cabling to be provided to each CDS front end rack pair (the normal CDS rack configuration).

Table 1: Common Rack Cabling

<i>Function</i>	<i>Cable Type</i>	<i>Qty</i>
Networking	Category 5 copper	3
Telephone	Category 5 copper	1
Timing	RG-58	1
110VAC Service	3 conductor, 20A	4

3.6.6. Facility Power

Two 110VAC/16A service lines will be provided to each CDS rack. This service will be brought through conduits encased in the concrete flooring from 20A breaker panels on the building walls at various locations. CDS rack power feed locations are shown in LIGO D960073-E (See Appendix B).

4 TIMING SYSTEM

4.1. Design

The CDS timing system is based on the Global Positioning System (GPS). A GPS antenna and receiver will be located at each mid and end station, along with one at the corner station area to serve the LVEA and OSB.

The system layout is shown in Figure 10: Timing System Overview. At each LIGO building area, a GPS antenna will be mounted on the roof and connected via a coax and serial communication line to a VME based Odetics TSAT-VME GPS receiver module in one of the CDS VME crates in the area. All other VME crates within the building/corner station area will house Odetics TPRO-VME GPS slave modules. The actual receiver circuitry is housed in the antenna unit. The difference between the VME receiver module and the slaves is only in that the receiver module has the added connections to accept the antenna inputs.

Once the receiver is powered up, it takes up to 30 minutes (<5 min. typical) to acquire enough satellite information to get accurate time information (time dependent on how long the system has been off). Once time information is acquired, it is available:

1. To the VME processor over the backplane via direct memory locations.
2. To VME slave units via IRIG-B connections.

In addition to time-of-day information, the receiver and slave VME units produce selectable phase-locked TTL clock outputs with frequencies of 2^n Hz, from 1Hz to 128KHZ. These clocks will be used as synchronization inputs to DAQ modules and control and monitoring signal digitizers.

The GPS module design also allows VME interrupts to be generated at these clock frequencies. These will be used to synchronize time critical software events.

4.2. Interfaces

Interfaces to the timing system are:

1. At the VME backplane connection to the receiver/slave modules.
2. At the timing clock output jack on the module front panel.

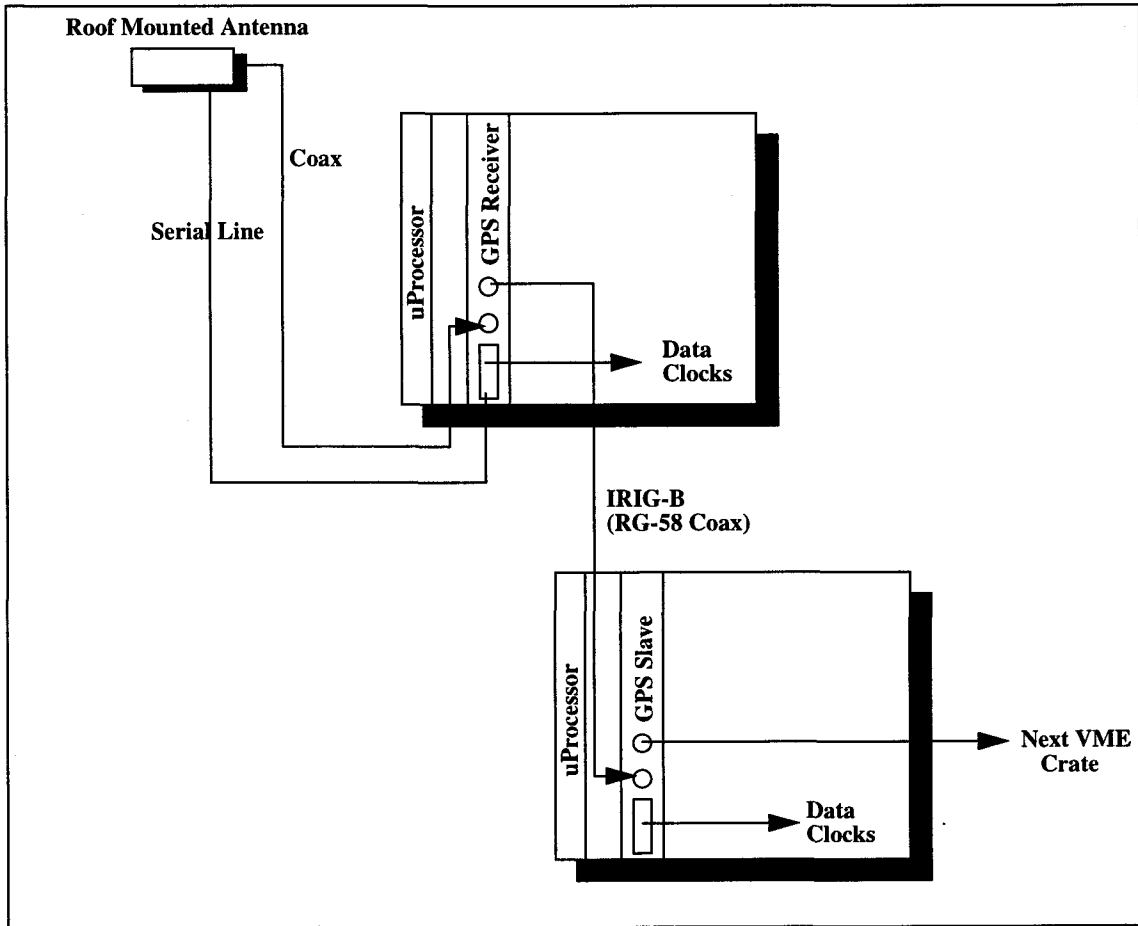

Figure 10: Timing System Overview

5 COMMUNICATIONS

5.1. Networking

To meet the computer networking demands of CDS, several networks will be provided. These are as follows:

1. CDS Control and Monitoring Network (CMN): This is the general data network of CDS and will provide standard control and monitoring, video and burst data networking facilities.
2. Data Acquisition System (DAQS) Network: This is to be a private, high performance network to provide the high bandwidth needs of moving data from DAQS data collection units to the DAQS frame-builders.
3. Real-time Network (RTN): This network (or networks) will provide for real-time network demands which may be placed on CDS for closed loop control which requires communication between multiple processors, such as for the ASC/LSC.

These three networks are described in the following subsections.

5.1.1. CDS Control and Monitoring Network (CMN)

CMN is the primary backbone structure which will be provided to meet the General Controls, Burst Data and Video network data communication requirements. An overview is shown in Figure 11: CDS Control and Monitoring Network. Key components of the system are:

1. ATM Backbone: The backbone of the CMN is a 155Mbit/sec OC-3 ATM network. The solid lines in the figure are each 155Mbit/sec connections, with an ATM switch as a hub, which is capable of switching speeds to 4Gbit/sec. This, in essence, gives each device which directly ties to the switch a private 155Mbit/sec network link.
2. Ethernet Switches: Ethernet switches provide connections to control processors throughout the site, as well as to framebuilder processors and control room peripheral equipment. These switches contain 16 ethernet ports and a 155Mbit/sec ATM uplink. This provides a dedicated 10Mbit/sec ethernet link to all connected devices. Again, the switching speeds of these units is up to 4Gbit/sec.
3. ATM Work Group (WG) Switch: All operator consoles within the FCR are to be provided with 25Mbit/sec ATM via CAT5 cable. These connect into ports in the WG Switch, which then has a 155Mbit/sec ATM uplink to the ATM Backbone Switch.
4. Video convertors: Video to ATM transmitters will be used to transfer video images from cameras located throughout the site. These units provide inputs for up to three video cameras, along with outputs to control camera pointing, focus, etc. The video is captured and transmitted via an ATM uplink, which connects to the ATM switch. This video can then be displayed on any workstation connected to the CDS network.

With this architecture, the network bandwidth figures would be:

- Aggregate bandwidth: Up to 4Gbits/sec (ATM Switch performance limit)
- Maximum bandwidth between two processors: 155Mbit/sec (Both processors directly connected to ATM backbone switch)

- Minimum bandwidth between two processors: 10Mbit/sec (Both processors connected to Ethernet switch)

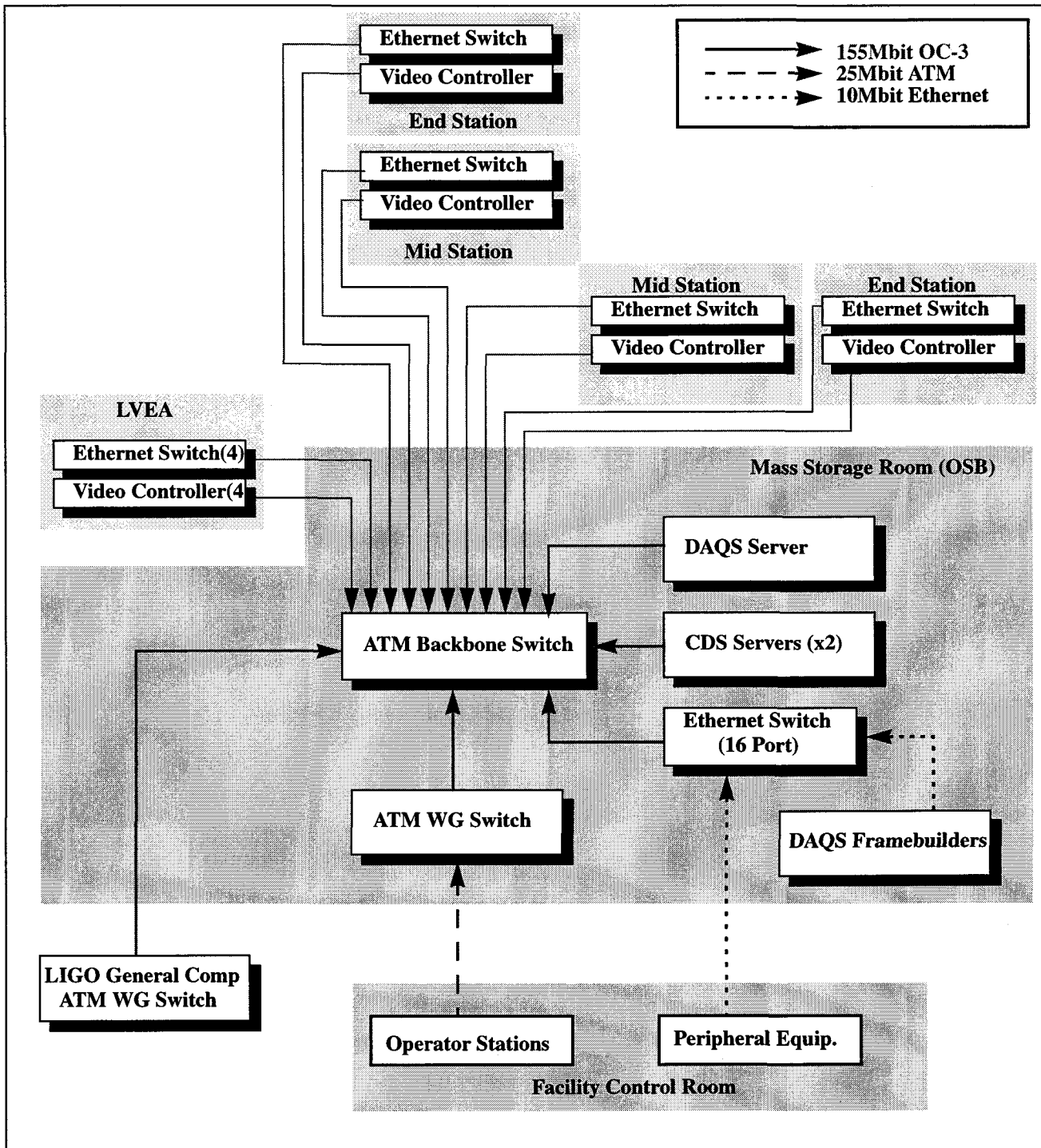

Figure 11: CDS Control and Monitoring Network

5.1.2. DAQS Network

The DAQS network is to be a private network for the communication of acquired data from the DAQS DCU to the DAQS framebuilders. This network is to be based on high performance reflected memory. Reflected memory and the architecture of this network is described in the DAQS Conceptual Design, LIGO T960010-C. DAQS connections to the CMN will provide for general configuration, control and monitoring of the DAQS.

5.1.3. CDS Real-Time Network (RTN)

The design of the RTN is TBD, pending further design and analysis of IFO systems, such as the ASC/LSC, which may require it. The general approach for providing real-time networking are to be:

1. Direct ATM interfaces to all processors which require real-time communication with connection through the CMN ATM network fabric. Private Virtual Channels (PVC) would be established between cooperating processors to provide dedicated bandwidth.
2. If bandwidth requirements of the closed loop preclude connection through CMN and PVC, direct links (independent of the CMN network fabric) would be provided.

5.2. Phone Service

CDS is to provide telephone service at various racks in the LVEA and mid and end stations. For the LVEA, a phone line trunk will be run from the OSB general computing room panel to rack 1X6 in the LVEA. Phone lines will then be routed out front a patch panel in the side of the rack to various other LVEA rack locations.

For the mid and end stations, phone communications will be provided via telephone software on computer workstations and the control and monitoring network back to the FCR operator consoles.

5.3. Communications Cable Plant

The following table describes the network and telephone cable plant to be provided by CDS for the LIGO Hanford site. In addition, Appendix D contains drawings of the network cable routing for the Hanford corner, mid and end stations. The Livingston site cabling will be similar, less the network connections for the second interferometer and no network connections to the mid station.

Table 2: CDS Network Cable Plant

<i>From</i>	<i>To</i>	<i>Function</i>	<i>Type</i>	<i>Qty</i>
FCR	Mass Storage Rm	ATM 25/Ethernet	Cat5 Copper	20
Mass Storage Rm	LVEA 1X6	ATM/Reflected Mem.	Fiber Optic (12 fibres)	1
Mass Storage Rm	LVEA 1Y9	ATM/Reflected Mem.	Fiber Optic (12 fibres)	1
Mass Storage Rm	LVEA 1Y12	ATM/Reflected Mem.	Fiber Optic (12 fibres)	1

Table 2: CDS Network Cable Plant

<i>From</i>	<i>To</i>	<i>Function</i>	<i>Type</i>	<i>Qty</i>
Mass Storage Rm	LVEA 2X4	ATM/Reflected Mem.	Fiber Optic (12 fibres)	1
Mass Storage Rm	Mech. Rm	Ethernet	Category 5 Copper	4
Mass Storage Rm	Chiller Plant	Ethernet	Category 5 Copper	2
General Comp. Rm	Mech. Rm	Phone Lines	Multi-conductor Cable	1
General Comp. Rm	LVEA 1X5	Phone Lines	Multi-conductor Cable	1
Mass Storage Rm	Mid Station 1	ATM/Reflected Mem.	Fiber Optic (12 fibres)	1
Mass Storage Rm	End Station 1	ATM/Reflected Mem.	Fiber Optic (12 fibres)	1
Mass Storage Rm	Mid Station 2	ATM/Reflected Mem.	Fiber Optic (12 fibres)	1
Mass Storage Rm	End Station 2	ATM/Reflected Mem.	Fiber Optic (12 fibres)	1

6 OPERATIONS SUPPORT

An overview sketch of the CDS areas of the OSB are shown in Figure 6 of Appendix D. The CDS areas are:

- A Facility Control Room (FCR), from which normal LIGO operations are carried out.
- Computer/Mass Storage Area, which contains compute servers and disk drive and tape units.
- An Electronics Shop, where CDS systems are developed and maintained.

6.1. Facility Control Room

A concept for the FCR is shown in Figure 6 of Appendix D. The layout includes five operator consoles/stations. During the LIGO commissioning phase, the five consoles provide space for the larger engineering and scientific staff typically involved in commissioning activities. As LIGO moves into more steady-state operations, two stations are intended as the main consoles for the two LIGO operators on shift, with the other three remaining consoles available for additional staff performing machine studies and tuning activities.

6.2. Operator Stations

The CDS will provide three types of operator stations:

- Operator Consoles at the FCR
- Single, fixed/portable workstation locations at various points throughout the ligo laser/vacuum equipment buildings.
- Portable laptop stations

6.2.1. FCR Consoles

The operator console enclosures are low bay 19" rack units (24"W x 46"H x 48D"). These units have lighting in overhang space to provide lighting to the counter top area. Interspersed with the rack units will be desktop units of the same design, some with glass tops with recessed areas for printers. Each console will have up to four bays for mounting of high resolution monitors, telephones, test equipment, and book storage.

The core of each console is a Sun UltraSparc2 workstation, with three 20" high resolution color monitors, single keyboard, mouse and knob box. These units have four S-bus slots, with three devoted to graphics monitors and the fourth an ATM network interface card.

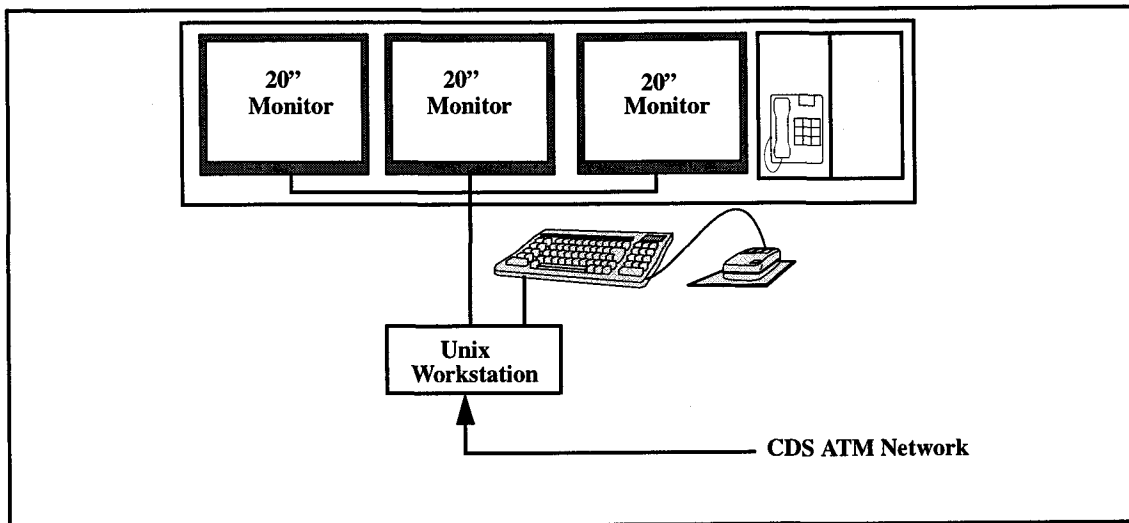

Figure 12: Operator Console Computer Equipment

6.2.2. Fixed/Portable Workstations

To meet the requirements of stand-alone operation of the Vacuum Control and Monitoring System (VCMS) during vacuum equipment acceptance testing, VCMS racks will be equipped with single Sparc5 workstations. After the acceptance tests, these workstations will be mounted to portable carts for use as local operator stations for interferometer system commissioning and maintenance.

6.2.3. Portable Laptop Stations

For operation local to the equipment being controlled/monitored, the CDS racks provide an ethernet connection for use by lap top personal computers. These computers will be provided with networking and X window software to allow viewing of any CDS displays available on the network.

6.2.4. Remote Access

Via the CDS main network router, LIGO staff within OSB offices and from other LIGO sites will be provided access to CDS displays and information. This "outside" access will be provided at a lower priority to ensure the CDS system does not become overburdened by external systems.

6.3. Computer/Mass Storage Area

The Computer/Mass Storage (CMS) area will house the control and monitoring and data acquisition compute servers, mass storage units, networking equipment, and other CDS support equipment. Appendix D, Figure 5 shows a preliminary layout and rack assignment.

6.3.1. Control and Monitoring Server

The control and monitoring server will consist of:

- Two UltraSparc2 server computers

- Two 30 GByte Disk Arrays
- A tape backup unit (TD-1), which is a 20 tape (8mm) robot unit with dual drives (3MByte/sec/drive)

6.3.2. Uninterruptable Power Supplies (UPS)

UPS will be provided as necessary to keep the following operational during a power outage for up to 30 minutes:

- Control and Monitoring and Data Acquisition System servers
- Network hubs
- One operator console and its associated equipment

For real-time front end processors, their criticality will be analyzed as part of the subsystem design, and UPS provided if deemed necessary and appropriate.

6.4. Software

Operational support software, in the context of this document, is that software which provides SCADA functions on non-real-time platforms. This software is run primarily under Unix and includes (as shown in upper half of Figure 1 of Appendix E):

- HMI
 - Sammi
 - DaDisp
 - AVS
- Data Archival and Retrieval
 - AR
 - ARR
- Alarm Management
 - ALH
- System parameter save and restore
 - BURT
- Application Programmer's Interface
 - Channel Access (CA)
 - Easy Channel Access (EZCA)

The general philosophy which will be employed in defining and developing this software will be:

1. First, and foremost, meet the LIGO requirements.
2. Use third party development tools, to the extent possible, such that code development can be more productive, particularly given the small CDS group size budgeted. These tools should provide:
 - Maximum productivity
 - Outside support i.e. a commercial product or "free-ware" which is supported by third parties. With many products available commercially and again the limited CDS group size, it is not desirable to build new tools.
3. Standardize as much code as possible and structure it for reuse.
4. Provide for cross-platform support. Being an extended project, new computers and technologies will

come about over the life of the project. The concept is to develop/use software which will be as portable as possible.

6.4.1. Operating Systems

The primary operating system for non-real-time applications will be Unix. Windows 95 platforms will also be supported for the HMI applications.

6.4.2. Compilers

Compilers for C, C++ and Fortran will be provided. However, for direct connection of software to CDS real-time data, only C code will be supported. This is due to the fact that all data interface routines presently available to provide data connections to EPICS channel access are written in C. There are no plans to provide C++ or Fortran versions of this API software (see section 6.4.9. Application Programmer's Interface).

6.4.3. Communications

EPICS channel access will provide the primary communication mechanism between operational support software and the real-time processes actually providing control functions in the VME crates.

6.4.4. Human-Machine Interface

6.4.4.1 General Controls

For purposes of both developing HMI and providing the primary interactive runtime HMI, the Sammi product from Kinesix will be used. An example and flow diagram is shown in Figure 3 of Appendix E. To make the connection with Sammi to the real-time data provided by EPICS, the Sammi API and a custom API to EPICS was developed. Some of the features provided by Sammi are:

- Graphical Motif screen development tools.
- Standard control dynamic and static widgets.
- General drawing capabilities.
- Various 2D plotting functions, including bar graphs, pie charts, X-Y plots, histograms.

6.4.4.2 Additional HMI

While Sammi is to provide for the bulk of operator displays for interactive control, various other software packages will continue to be tested during the final design phase (and probably beyond as new packages and updates surface) for purposes of displaying various data plots and providing data analysis. These will be looked at under the auspices of interferometer diagnostic system design. The short list includes:

- Advanced Visualization System (AVS): This is the present LIGO standard software for modeling and analysis efforts. As software is developed by other groups using AVS, it will be incorporated into the CDS if the packages developed are pertinent.
- DaDisp: A commercial package which provides analysis software routines as well as data presentation. Sammi does not contain data analysis software, so a complementary package, such as DaDisp, will be looked at to provide additional features.

6.4.5. Data Archival and Retrieval

Examples of the data archival and retrieval software are shown in Appendix E, Figures ~~3~~⁴ and ~~4~~⁵.

6.4.5.1 Data Archival

Data archival for the Control and Monitoring portion of CDS consists of archive to disk/tape of:

1. Slow data (10 Hz or slower), recorded for purposes of analyzing trends in LIGO operations.
2. High speed (up to 20M samples/sec) snapshot data used to analyze servo loop systems.

The archival of continuous high speed data (up to 6MBytes/sec) will be handled by a separate CDS data acquisition system, described in LIGO T960010-C.

To perform these functions, the EPICS ARchiver (AR) extension will be used as the base, with LIGO extensions to be added. The archiver software arrangement is shown in Figure 3 of Appendix E.

To archive data, the user first develops an ASCII file, which denotes the data channels to be archived, how often, and to what file system. This file is then loaded to the AR runtime, which connects, via CA, to real-time data channels and performs the actual archive process.

AR has two limitations which will need to be addressed to meet LIGO requirements:

1. All data described by an ASCII file is archived to a single file. While this is satisfactory for short periods of data storage (several hours), data which is archived continuously over days takes an unsatisfactory amount of time (5 minutes or more when only a dozen channels are being archived over a 24 hr period once every 10 seconds) to retrieve from the AR format. The intent to correct this is to post process data files in a manner TBD. This has been a standing recommendation within the EPICS collaboration, but no one has stepped forward to undertake the task.
2. AR will not archive array data, such as would be the format of the high speed snapshot data. To accomplish this, either an extension will be made to AR or a separate CA client process built.

6.4.5.2 Archive Data Retrieval

EPICS provides two tools for the retrieval and display of archived data, AR and ARR. AR was the first developed package, with ARR a later development using tc/tkl. A plot window from the tc/tck version is shown in Figure 3 of Appendix E. Both packages provide:

- Point and click GUI
- Graphic and Tabular data representations.
- Multi-parameter, multi-scale, 2D plotting with zoom, pan, autoscaling, legends.
- Postscript printouts

However, these packages are limited in, among other items,:

- Data retrieval time. Data retrieval for long files (12+ hours) takes an uncomfortable amount of time to retrieve. This is due to a combination of the file formats and the ARR code itself.
- Scaling. Plots can only be on single scale or auto scale all. There is no feature for individually scaling multiple plots.
- Tool can only retrieve and plot data from one archive file at a time (no ability to call up and overlay data from multiple archive files).
- AR/ARR does not provide any data analysis functions.

Due to these shortcomings, while these packages will be available and used in the short term for prototype systems, they will be replaced over time by a commercial package. Since data will be archived and

need to be extracted both from EPICS in the control systems and separate software for the data acquisition system, a common data retrieval and display software package will be designed and implemented. This will be done through an interface to AVS or DaDisp (or similar package). An example window from DaDisp is shown in Figure 4 of Appendix E.

6.4.6. Alarm Management

Alarm enunciation, display and logging will be provided using the EPICS alarm manager (ALM). An overview of ALM is shown in Figure 5 of Appendix E. ALM allows for:

- The definition and structuring of alarm trees via an ascii editor using ALM keywords and guidelines.
- Alarm enunciation and display of the alarm tree.
- Alarm logging and playback.
- Defining and displaying operator guidance along with the alarm states.
- Defining and allowing operator execution of real-time processes to deal with alarm conditions.

6.4.7. Save and Restore

Save and restore provides the capability to take “snapshots” of CDS control settings/readings to allow resetting control parameters to the same configuration at a later time. The Back-Up and Restore Tool (BURT) of EPICS will be used to provide this functionality. Figure 6 of Appendix E depicts the user interface windows.

BURT provides:

- Collection and storage to user defined files of system setpoints and readings. Data to collect is defined by the user in ascii files using BURT keywords and structures.
- Resetting of setpoint parameters on demand from the operator.
- Viewing and modification capabilities prior to resetting values.
- Concatenation of multiple back-up files.
- Basic math routines to adjust back-up settings prior to resetting the real-time systems.

6.4.8. System Diagnostics

The initial set of diagnostics will be those provided with the VxWorks and Unix operating systems, along with the EPICS tools. The EPICS tools include:

- VxWorks command line interrogation, such as listing of records, records attached by SNL code, and status of I/O drivers.
- Probe: An X window tool which provides display of values from EPICS record fields.

In the longer term, GUI interfaces will be built onto the system to provide:

- Status of all CDS software modules.
- Status of all CDS I/O modules.
- Status of all CDS networks.
- Status of all CDS mass storage systems.

6.4.9. Application Programmer's Interface

To provide connection of CDS data to code developed by other user's the primary API will be the CA call libraries and the EZCA libraries. Both provide embeddable C calls to allow access to EPICS data via CA. CA libraries provide the most versatility in asynchronous callbacks, but require a higher level of programming skills. EZCA provides easier to use function calls, but is more limited in its capabilities. Instructions for use of these libraries are provided in the EPICS manual set.

**APPENDIX A CONTROL AND MONITORING
DRR ACTION ITEMS**

The following action items are reproduced from the Control and Monitoring DRR, along with the actions taken.

RECOMMENDED ACTION ITEMS

CONCEPTUAL DESIGN

1. Concern: Role of EPICS in on-line diagnostics and data processing unclear.
Action: Explicitly limit EPICS to data transfer and control protocol, or describe level of programming anticipated under EPICS (FFTs, Graphics, etc.)
Action Taken: The primary role of EPICS will be in data communication, providing the standard network protocols. Most real-time controls will be done through custom C code modules. EPICS extensions will also be employed to provide some data storage and visualization functions, such as alarm management and slow data storage and retrieval.
2. Concern: Unclear what limitations in computer language exist for the cross compiler development on the Sun targeting the proposed distributed processors.
Action: Provide table of cross compilers available (desired) or explicitly establish a standard language requirement.
Action Taken: Only compilers for real-time applications will be C. Fortran compilers will be available on Suns, but will not provide direct linkages to real-time data i.e. must get CDS data from files.
3. Concern: Need an early plan for test of digital feedback control for the longitudinal control system if proposed.
Action: If the requirements/design indicate a need, logistics and opportunities with 40m group should be resolved ASAP.
Action Taken: Will be reviewed in LSC subsystem designs.
4. Concern: The GPS CDS timing system drawing indicates a potential for lightning strike paths from roof-mounted antenna to CDS racks via conductors.
Action: Ensure that the specification for system when it is procured includes a paragraph addressing lightning-proof design.
Action Taken: Lightning protection will be analyzed and specified for procurement.

APPENDIX B CDS RACK LOCATION DRAWINGS

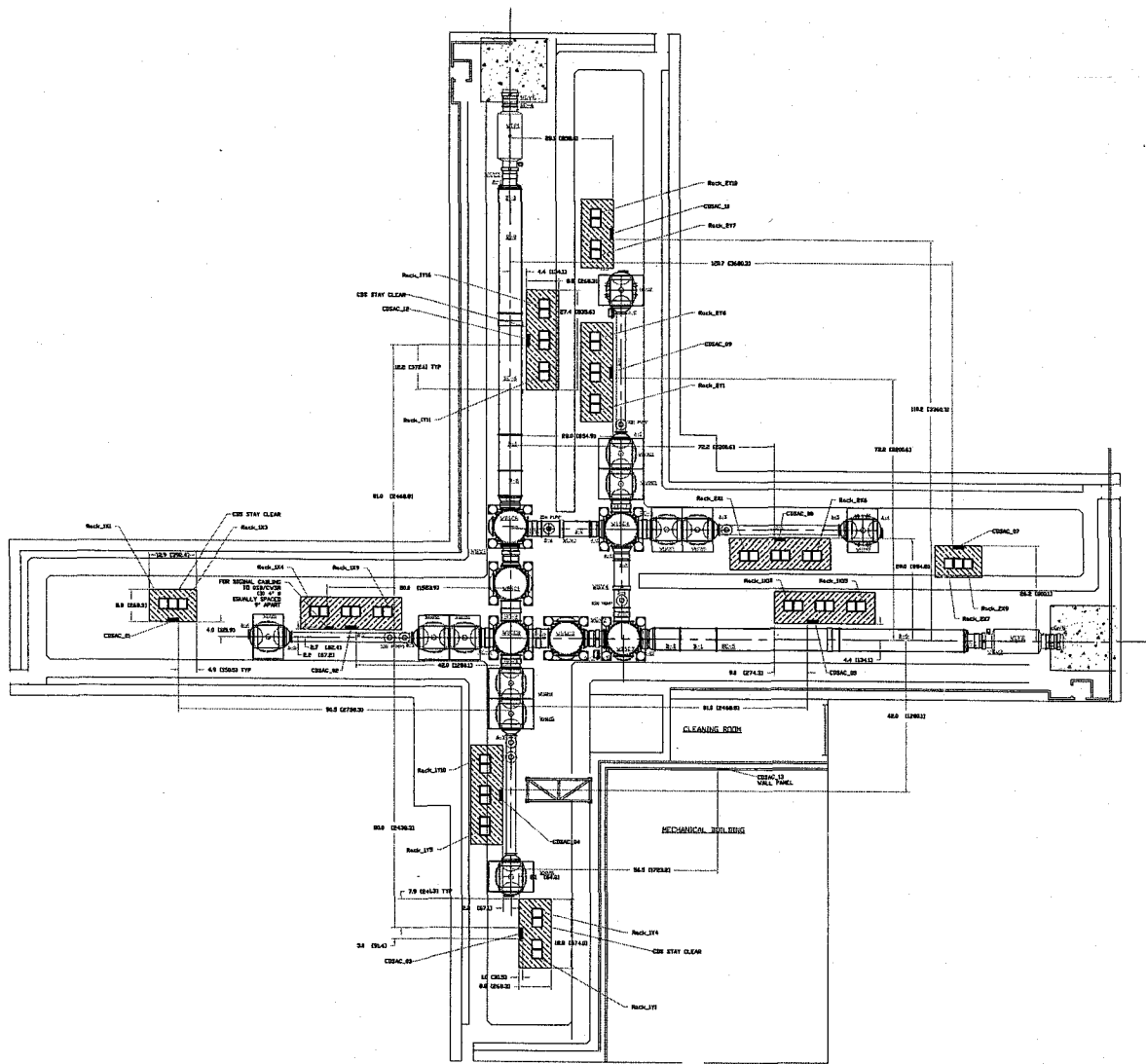

				UNLESS OTHERWISE SPECIFIED DIMENSIONS ARE IN FEET (and TOLERANCES: FRACTIONAL & ANGULAR DIMS ± BEND & TWO PLACE DECIMAL & THREE PLACE DECIMAL & FINISHES SURFACE FINISH BREAK CORNERS TO REMOVE ALL BURRS																				LIGO CALIFORNIA INSTITUTE OF TECHNOLOGY MASSACHUSETTS INSTITUTE OF TECHNOLOGY	
				DO NOT SCALE THIS DRAWING										PRE-RELEASE										CHAMBER & RACK DESIGNATIONS VA (CORNER STATION)	
				USED ON										DESCRIPTION										Dwg. No. D960073-00-E	
Dwg. No.				DESCRIPTION										SYS DET CBS VE CC BT DRWN DATE										SCALE NTS SHEET 1 OF 3	
REFERENCE DRAWINGS				NEXT ASS'Y										ISSUE DESCRIPTION											

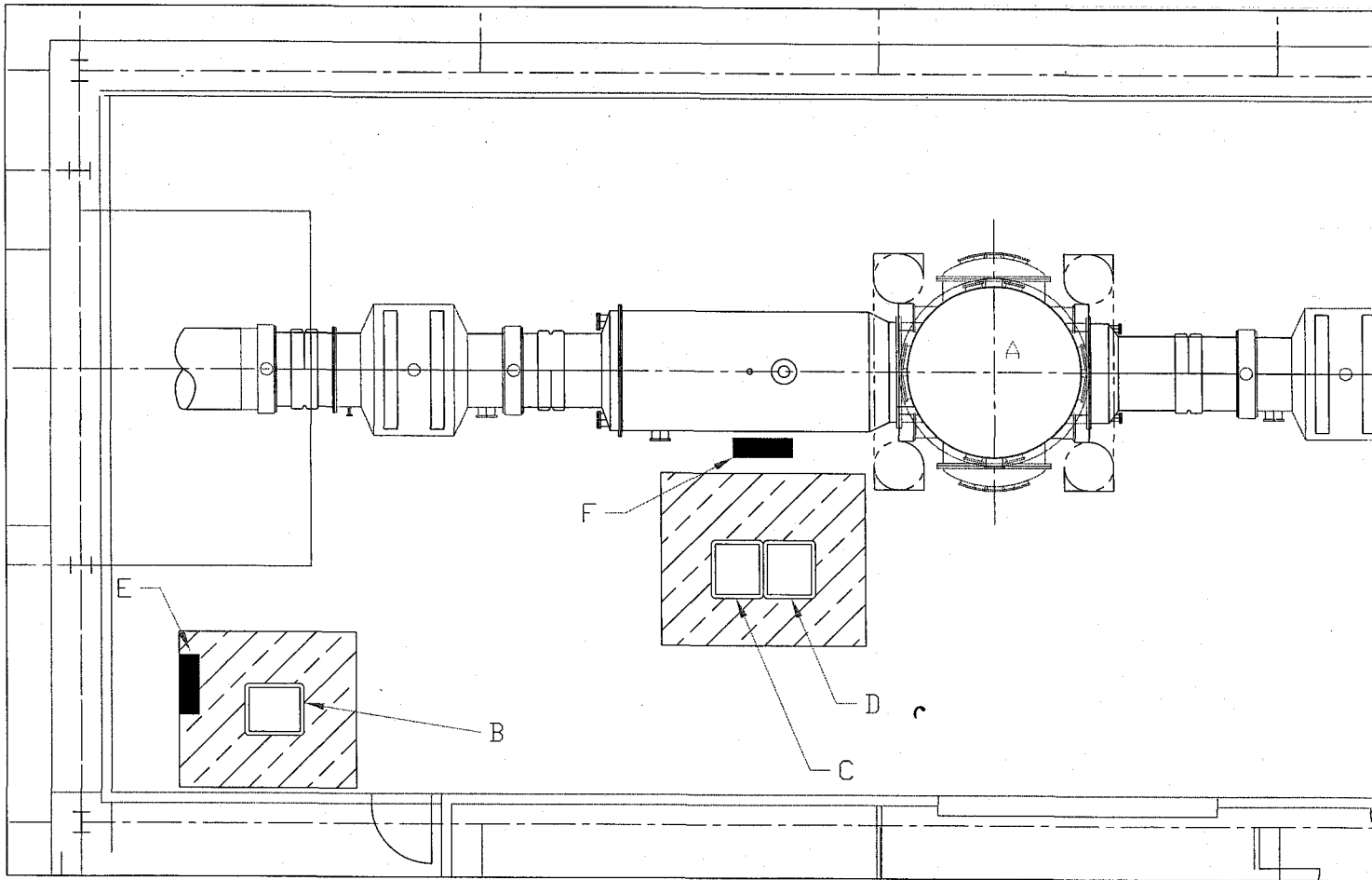

MID STATION

CHAMBER & RACK DESIGNATION TABLE		
	X-ARM	Y-ARM
A	VBSC5	VBSC6
B	RACK_1X16	RACK_1Y17
C	RACK_1X17	RACK_1Y18
D	RACK_1X18	RACK_1Y19
E	CBSAC_6	CBSAC_16
F	CBSAC_11	CBSAC_17

LIGO CALIFORNIA INSTITUTE OF TECHNOLOGY MASSACHUSETTS INSTITUTE OF TECHNOLOGY			
CHAMBER & RACK DESIGNATIONS WA (MID STATION)			
CAD FILE D960073a2-00.dwg	SIZE D	ENCL. NO. D960073-00-E	REV. 00
SCALE NTS	SHEET		2 OF 3

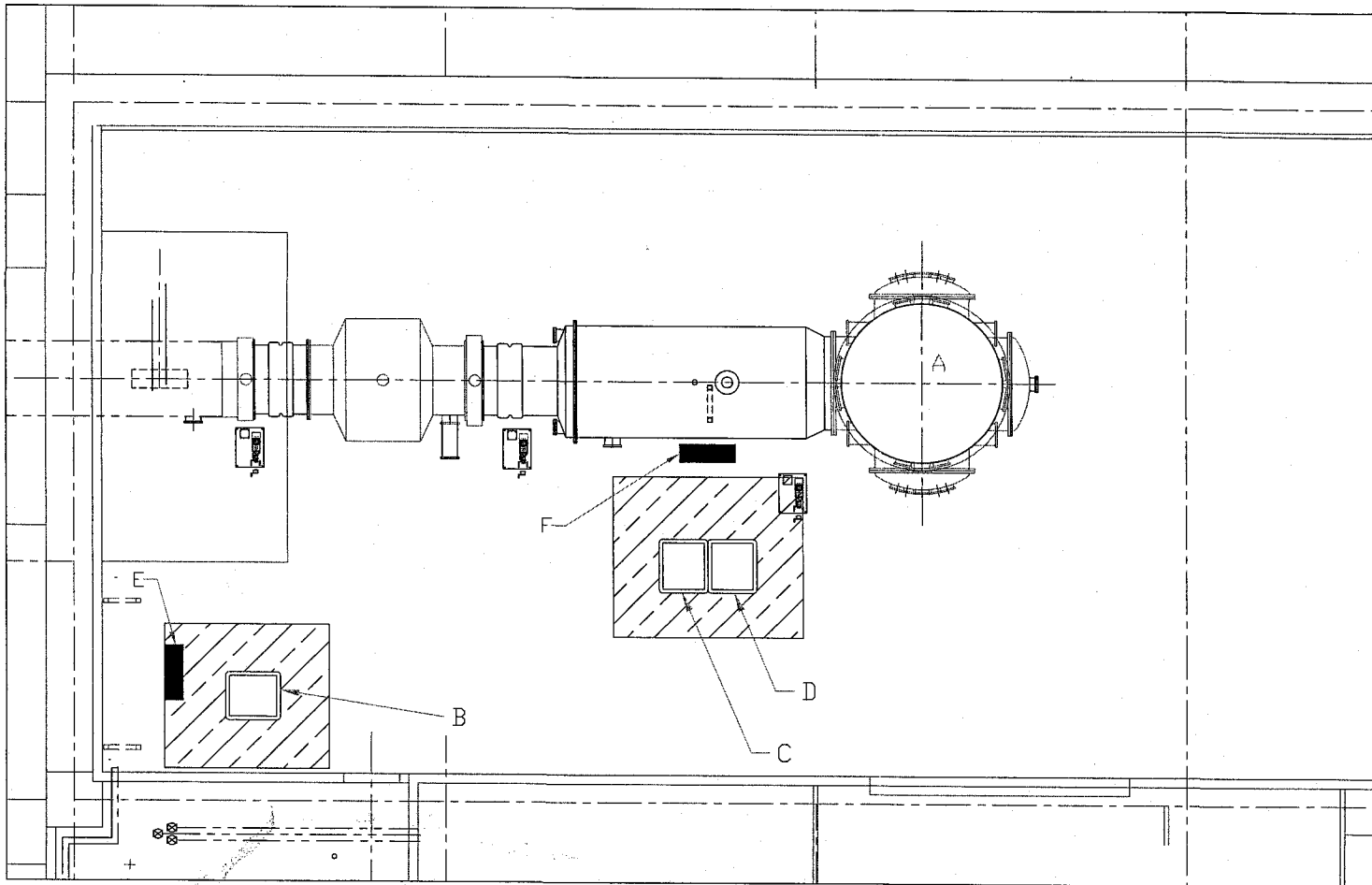

END STATION

CHAMBER & RACK DESIGNATION TABLE	
X-ARM	Y-ARM
A VBSC9	VBSC10
B RACK_1X19	RACK_1Y20
C RACK_1X20	RACK_1Y21
D RACK_1X21	RACK_1Y22
E CDSAC_14	CDSAC_18
F CDSAC_15	CDSAC_19

LIGO CALIFORNIA INSTITUTE OF TECHNOLOGY MASSACHUSETTS INSTITUTE OF TECHNOLOGY			
CHAMBER & RACK DESIGNATIONS WA (END STATION)			
Dwg FILE D960073e3-00.dwg	SIZE D	Dwg NO. D960073-00-E	REV. 00
SCALE NTS	SHEET 3 OF 3		

APPENDIX C CDS RACK LAYOUT DRAWINGS

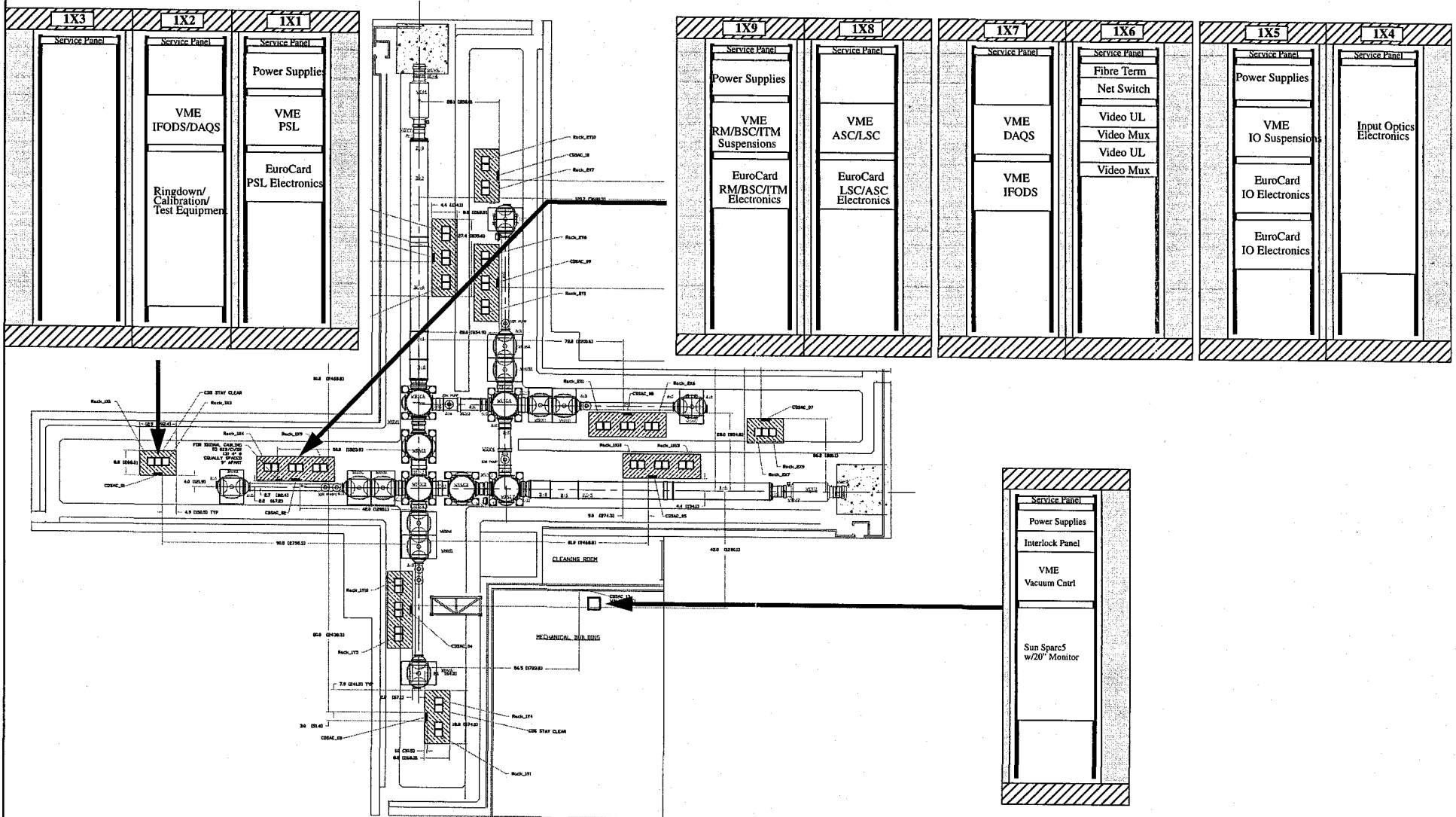

Appendix C - Figure 1
 Hanford LVEA/Mech. Rm.
 Rack Layouts 1X1-9/MR1

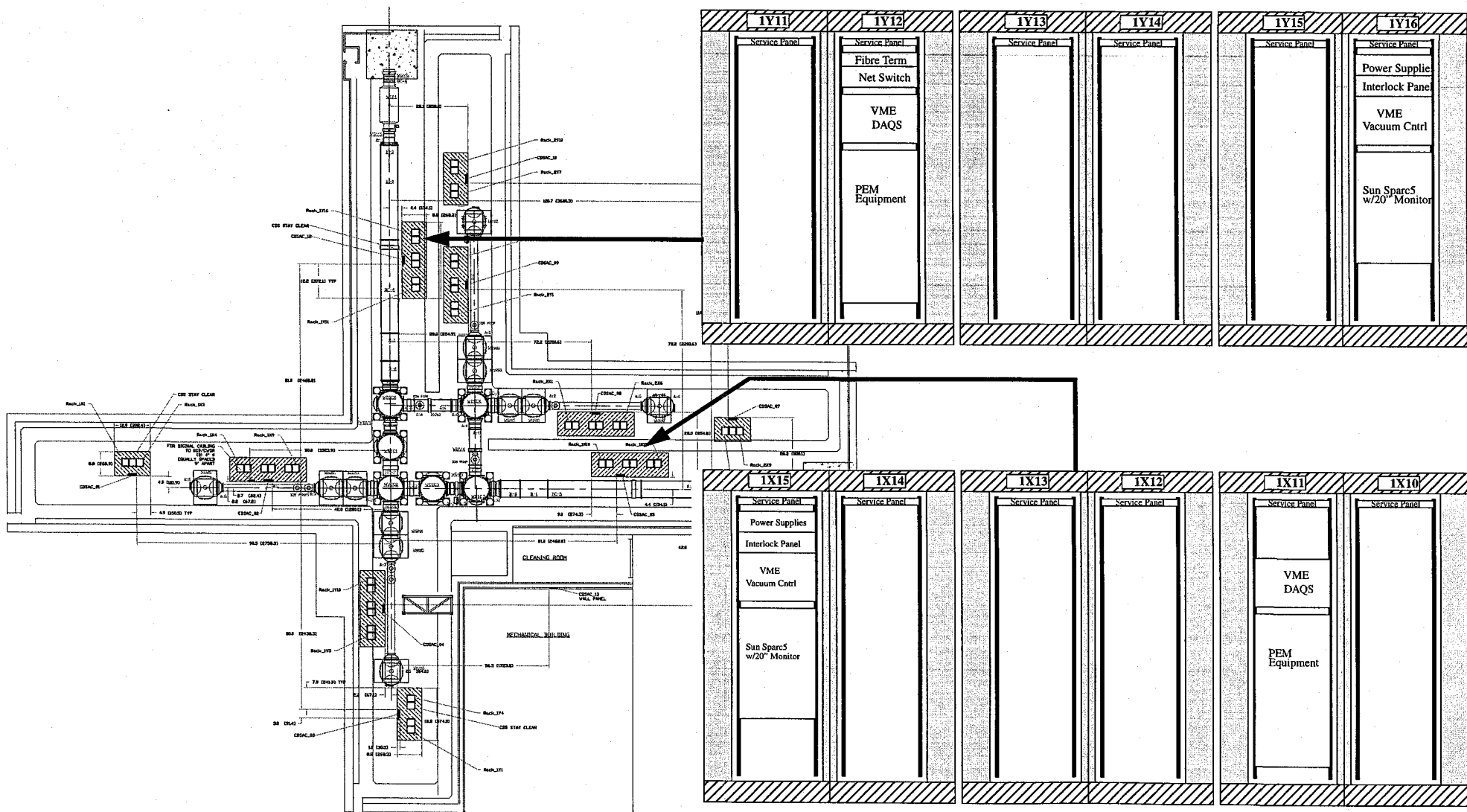

Appendix C - Figure 2
 Hanford LVEA
 Rack Layouts 1X10-15/1Y11-16

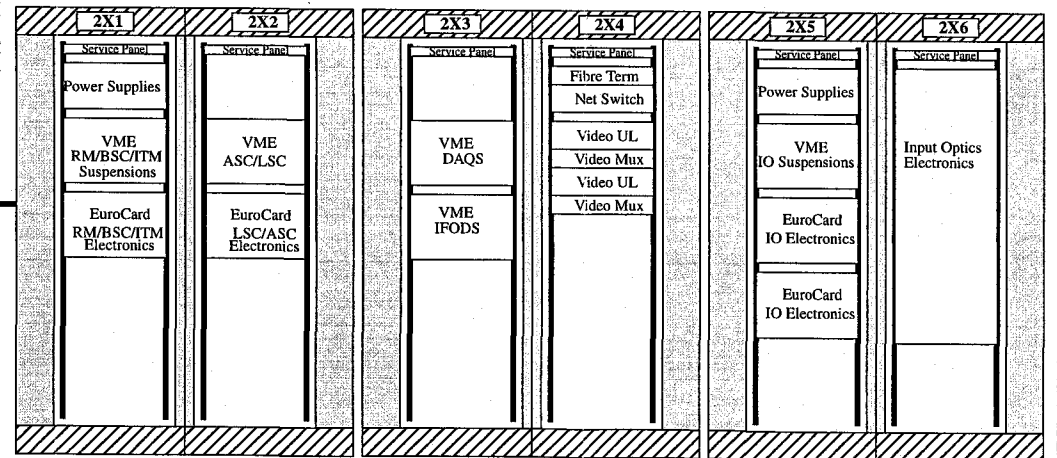
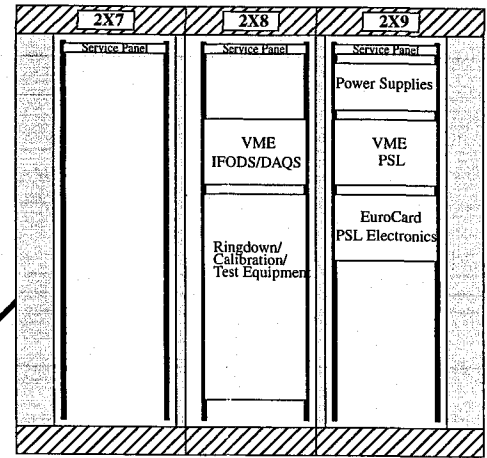
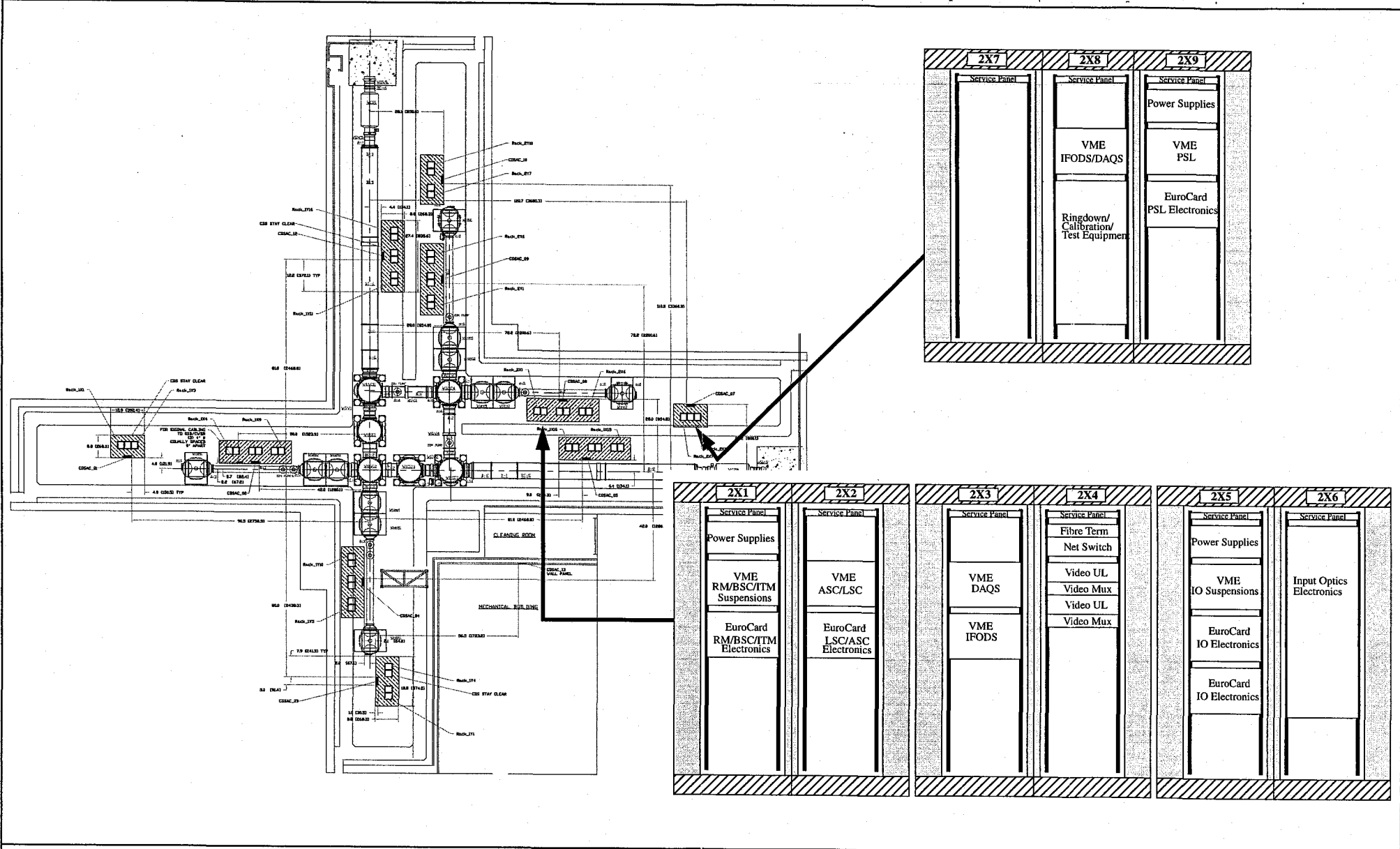

Appendix C - Figure 3
Hanford LVEA
Rack Layouts 2X1-2X9

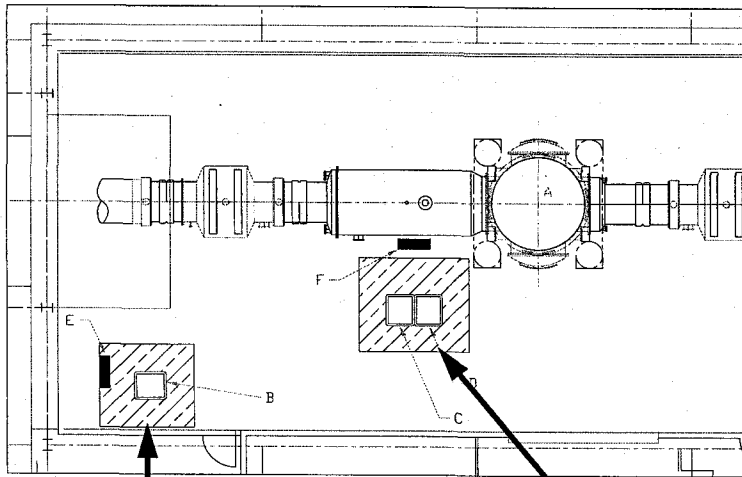

MID STATION

NO.	DESCRIPTION	QTY
1	1X16	1
2	1X17	1
3	1X18	1

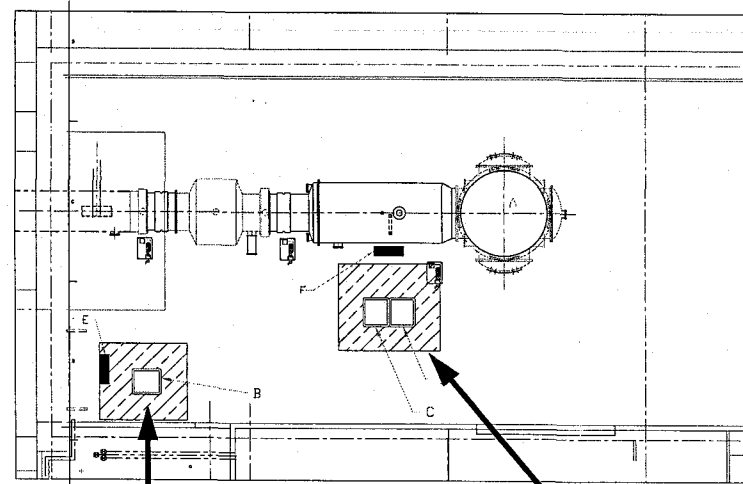
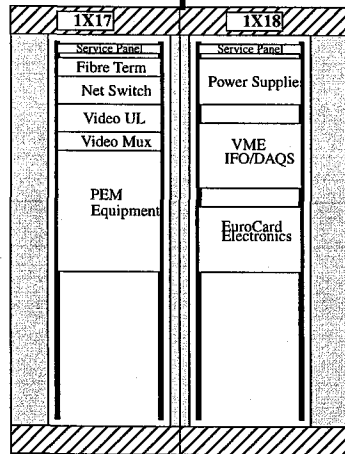
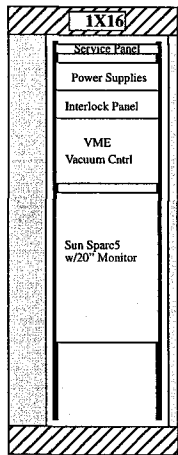

END STATION

NO.	DESCRIPTION	QTY
1	1X19	1
2	1X20	1
3	1X21	1

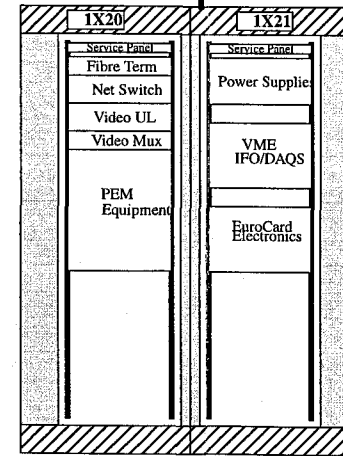
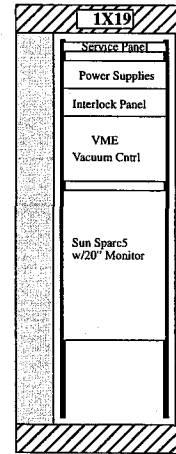

Appendix C - Figure 4
Hanford Mid/End Station
Rack Layouts

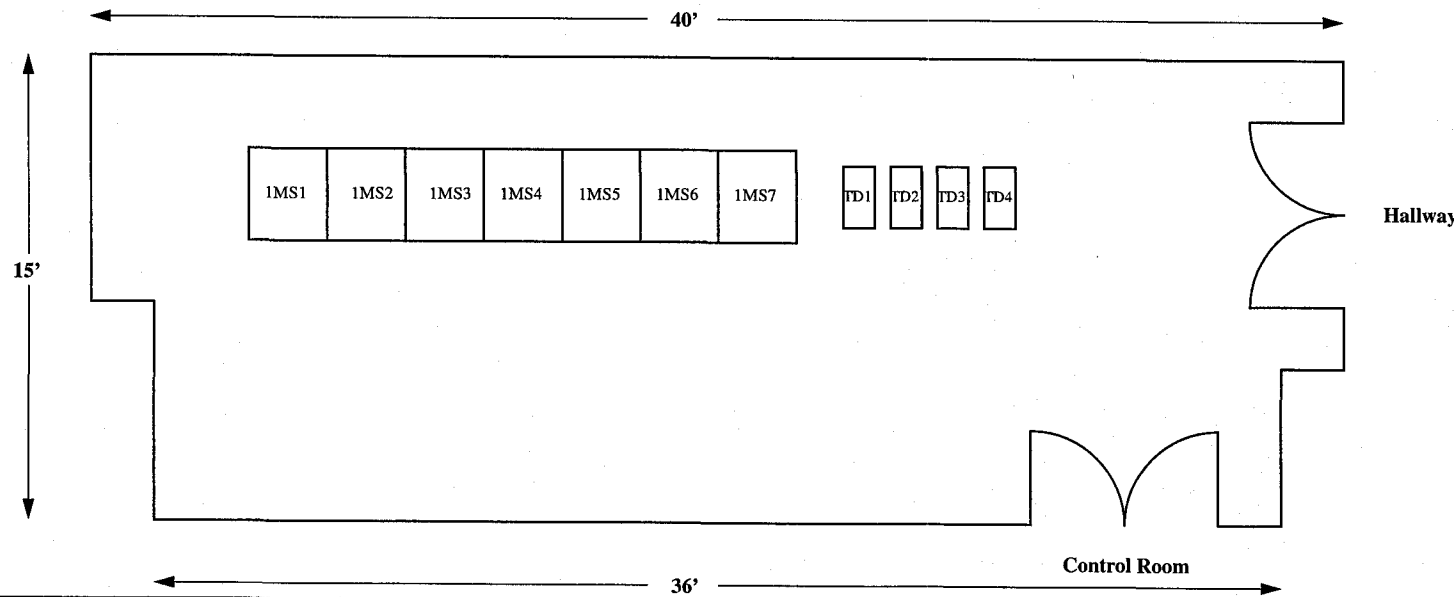
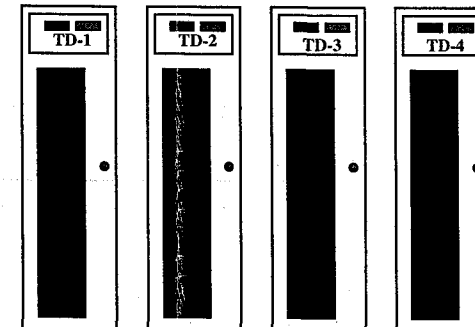
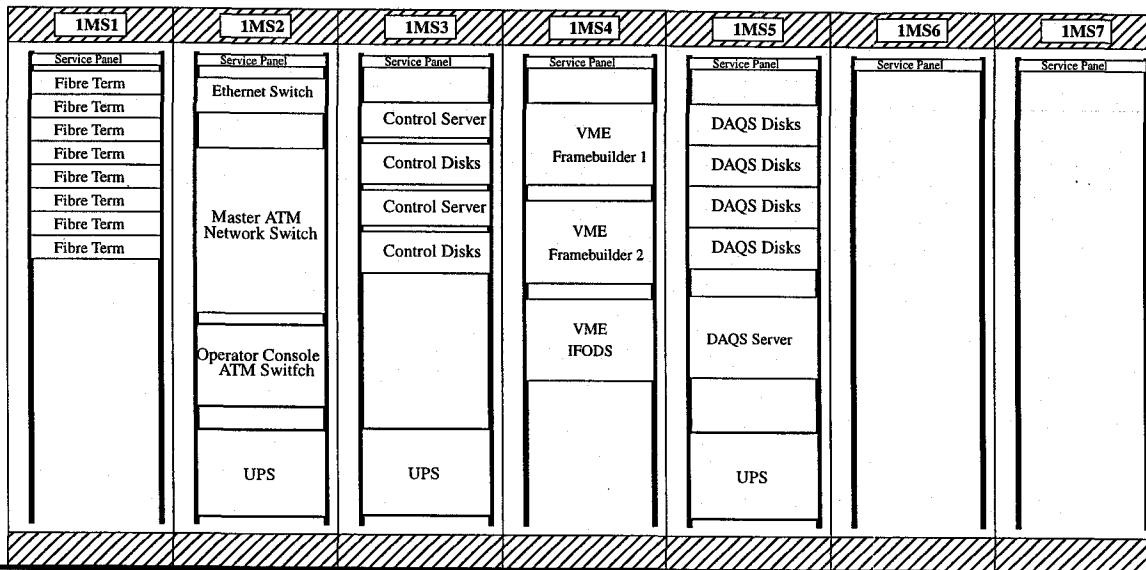

Appendix C - Figure 5
Hanford Mass Storage Rm.
Floor Plan / Rack Layouts

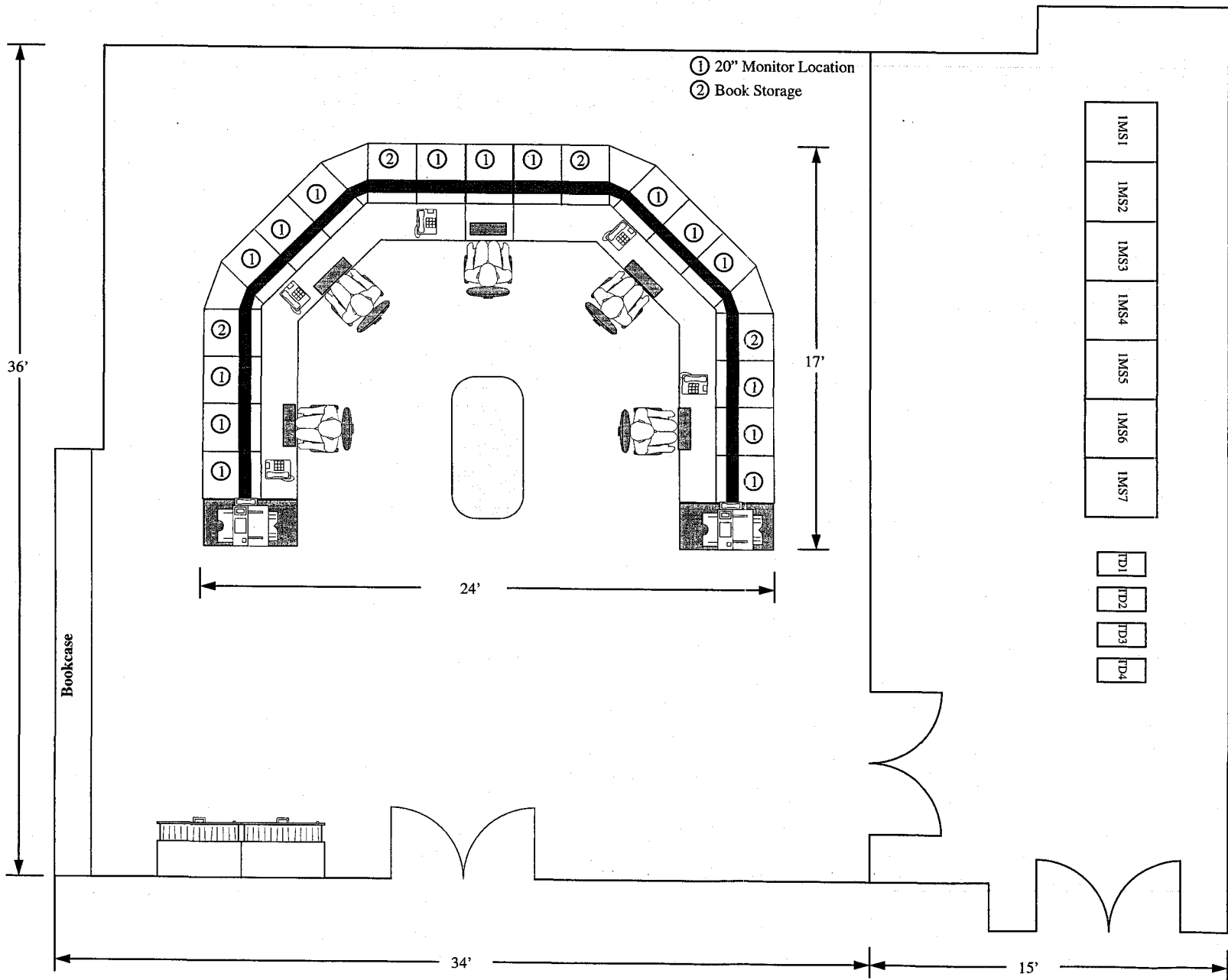

Appendix C - Figure 6
FCR/CMSR
Floor Plan / Rack Layouts

APPENDIX D CDS NETWORKING

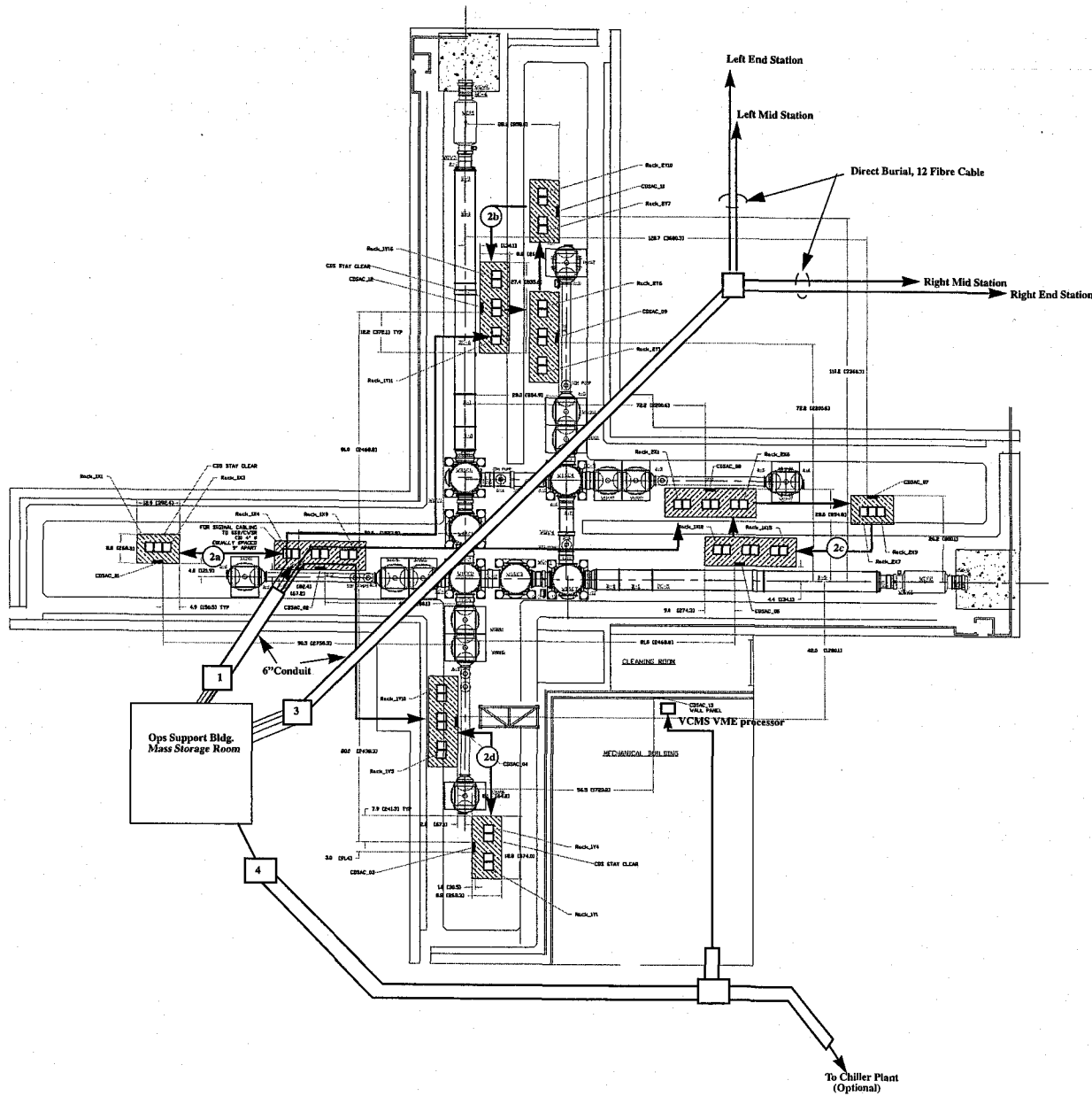

NOTES:

1) Four, 12 fibre cables originate at the OSB Mass Storage room and pass through 6" conduit to area of Rack 1X6. One fibre cable terminates at that rack. The three other cables continue thru cable tray to terminate at 1Y9, 1Y12 and 2X4. These termination racks also contain the ethernet switches.

2a,2b,2c,2d) Fibre pairs are looped through the rack clusters for the reflected memory network (one pair per rack cluster).

3) Four, 12 fibre, direct burial cables run from the mass storage room in the OSB via conduits under the LVEA to a hand access point on the inside of the LIGO arms. These cables are then run underground to the mid and end stations.

4) Cat5 Network cables are run via exterior 2" conduit to the mechanical room (for connection of VCMS processor(s) and to the Chiller Plant (TBD if latter required).

5) Cat5 cables are fanned out from the ethernet switches located in 1X5, 1Y9, 1Y12 and 2X4 to processors located in the nearby rack clusters e.g. switch in 1X5 covers processors in racks 1X1 thru 1X9.

6) All fibre cabling within LVEA is multi-mode. All fibre cabling to mid and end stations is single mode.

**Appendix D - Figure 1
Hanford Corner Station
Networking Cable Plant**

Mass Storage Room (OSB) ← Direct Burial, 12 Fibre Cable ← Hand Access

4" Conduit thru slab

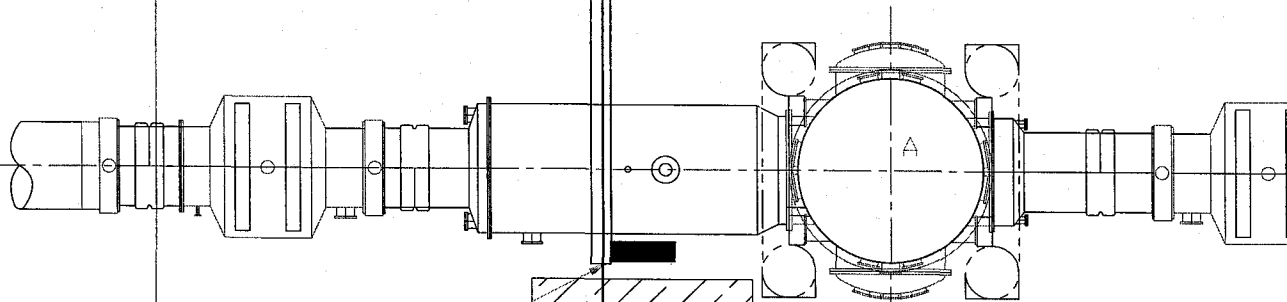

NOTES:

1) Direct burial, 12 fibre cable originates at OSB and connects to rack C in a fibre termination panel. Fibres are assigned as follows:

- 1&2 - ATM Network
- 3&4 - Reflected Memory Network
- 5&6 - ATM Video
- 7 thru 12 - Spare

2) Rack C contains an ethernet switch, from which CAT5 cables are run to processors in Racks B and D. Switch ports are assigned as:

- 1 - Vacuum Control Processor (Rack B)
- 2 - IFO Control Processor (Rack D)
- 3 - DAQS Control Processor (Rack D)
- 4 - Local Sun Workstation (Rack C)
- 5 - Laptop port (Rack B)
- 6 - Laptop port (Rack D)
- 7 - Facilities Monitoring and Control System

Termination Detail

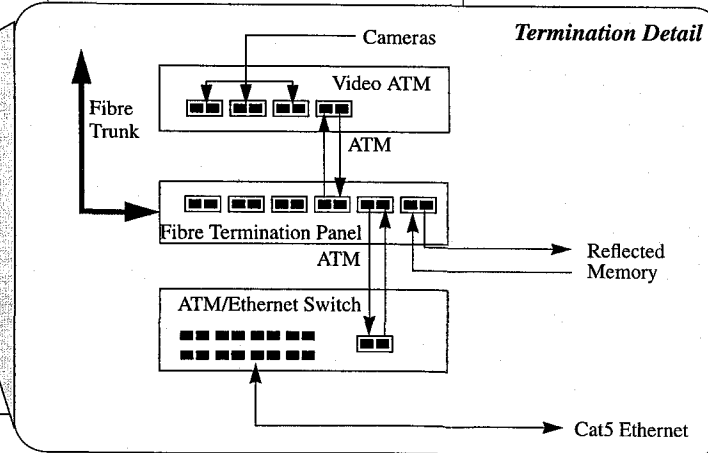

MID STATION

CHAMBER & RACK DESIGNATION TABLE		
	X-ARM	Y-ARM
A	VBSC5	VBSC6
B	RACK_1X16	RACK_1Y17
C	RACK_1X17	RACK_1Y18
D	RACK_1X18	RACK_1Y19
E	CDSAC_6	CDSAC_16
F	CDSAC_11	CDSAC_17

**Appendix D - Figure 2
Hanford Mid Station
Networking Cable Plant**

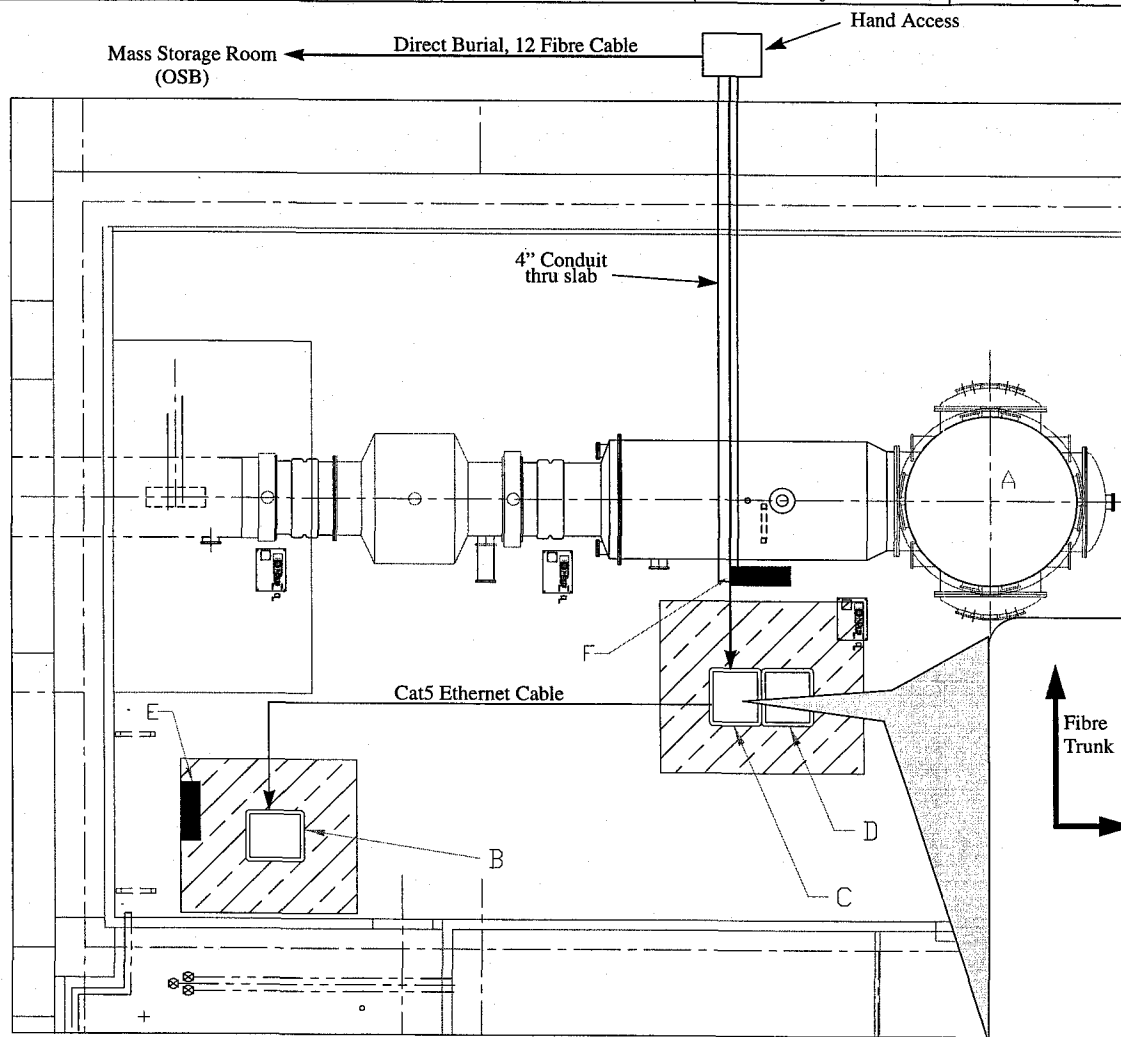

- NOTES:
- 1) Direct burial, 12 fibre cable originates at OSB and connects to rack C in a fibre termination panel. Fibres are assigned as follows:
 - 1&2 - ATM Network
 - 3&4 - Reflected Memory Network
 - 5&6 - ATM Video
 - 7 thru 12 - Spare
 - 2) Rack C contains an ethernet switch, from which CAT5 cables are run to processors in Racks B and D. Switch ports are assigned as:
 - 1 - Vacuum Control Processor (Rack B)
 - 2 - IFO Control Processor (Rack D)
 - 3 - DAQS Control Processor (Rack D)
 - 4 - Local Sun Workstation (Rack C)
 - 5 - Laptop port (Rack B)
 - 6 - Laptop port (Rack D)
 - 7 - Facilities Monitoring and Control System

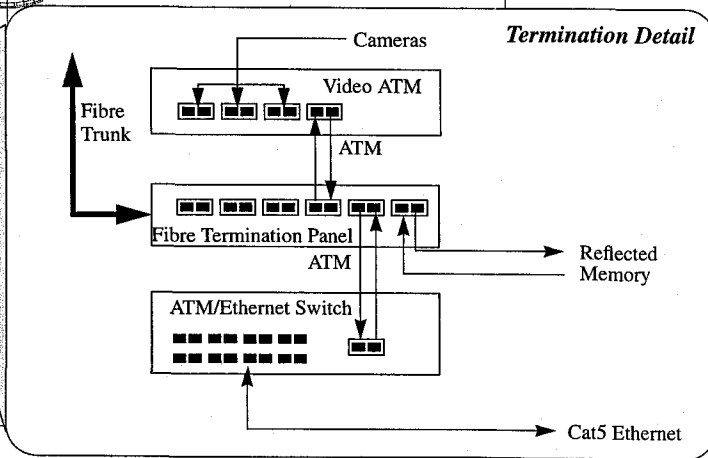

END STATION

CHAMBER & RACK DESIGNATION TABLE		
	X-ARM	Y-ARM
A	WBSC9	WBSC10
B	RACK_1X19	RACK_1Y20
C	RACK_1X20	RACK_1Y21
D	RACK_1X21	RACK_1Y22
E	CDSAC_14	CDSAC_18
F	CDSAC_15	CDSAC_19

Appendix D - Figure 3
Hanford End Station
Networking Cable Plant

APPENDIX E CDS SOFTWARE

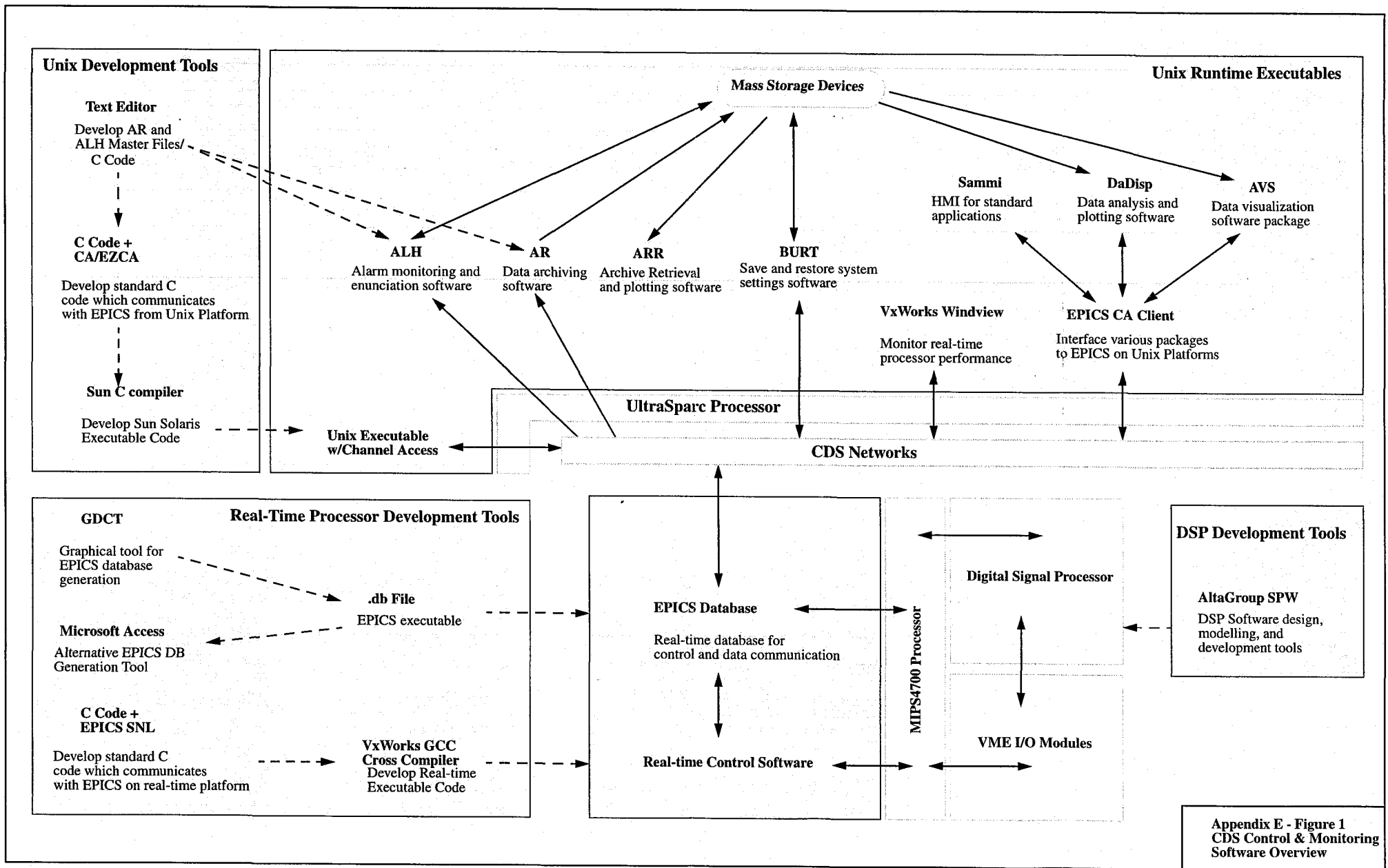

Main Menu

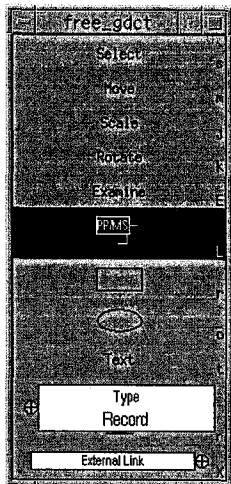

Software Record Data Definition

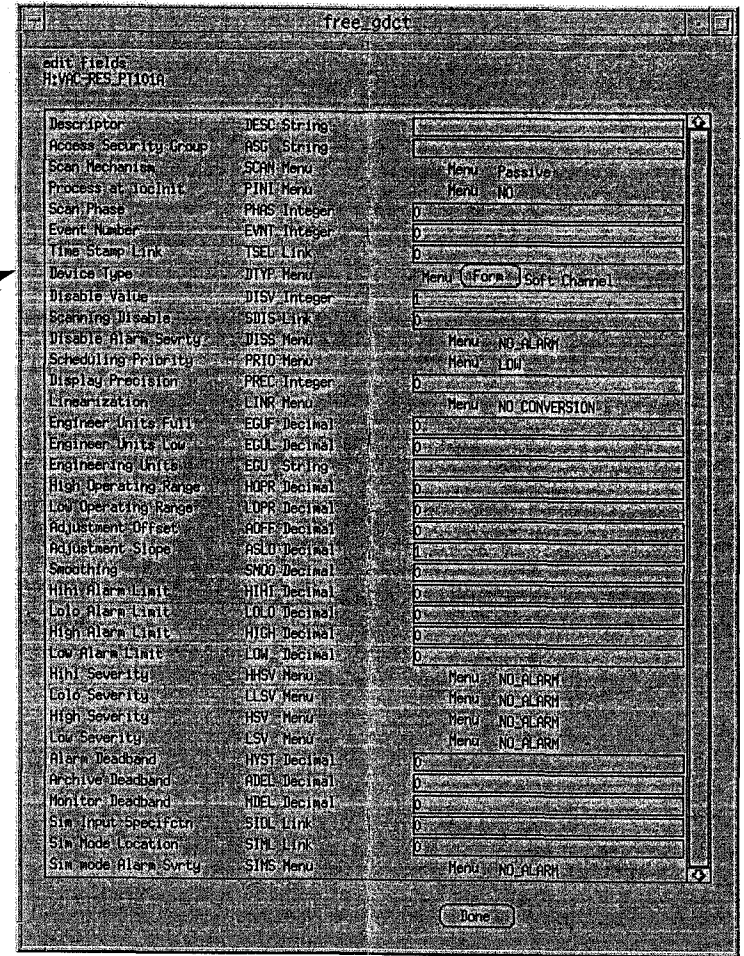

Database development Area
(Place and link software modules)

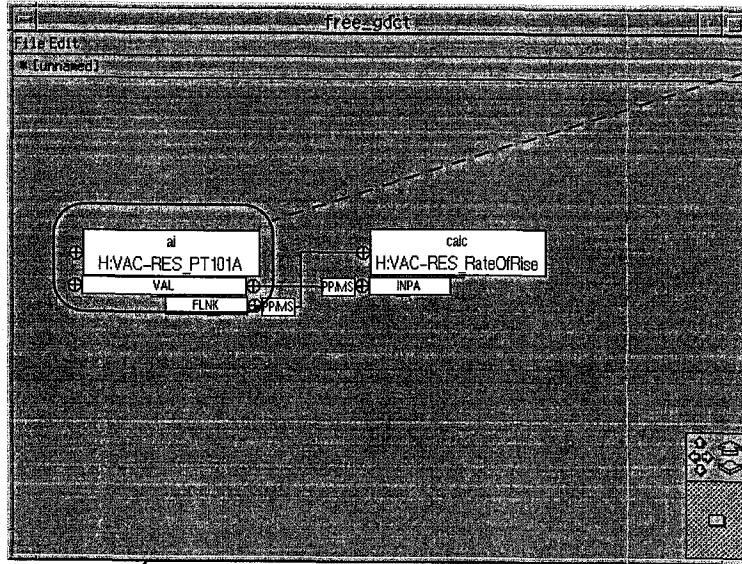

Appendix E - Figure 2
EPICS Graphical Database
Configuration Tool (GDCT)

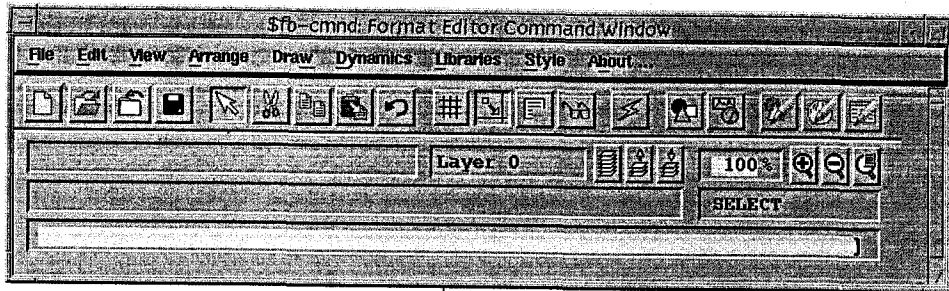

1

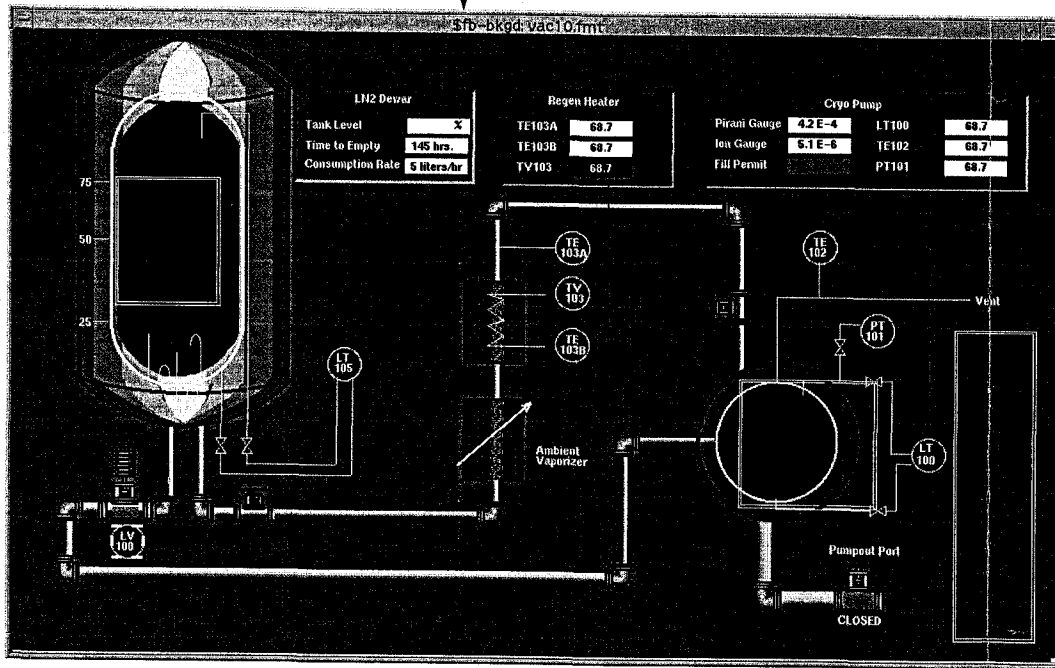

Sammi File

2

3

Sammi Runtime Environment

Sammi API

EPICS Client

EPICS Data

Sammi Overview

- 1) Display is built using Sammi Format Editor
- 2) Display is stored as Sammi File.
- 3) Display file is recalled into Sammi runtime environment.
- 4) Display becomes interactive with EPICS control and monitoring data made available through an RPC connection to an EPICS Channel Access Client program.

Appendix E - Figure 3
Sammi Editor and
Runtime Data Connections

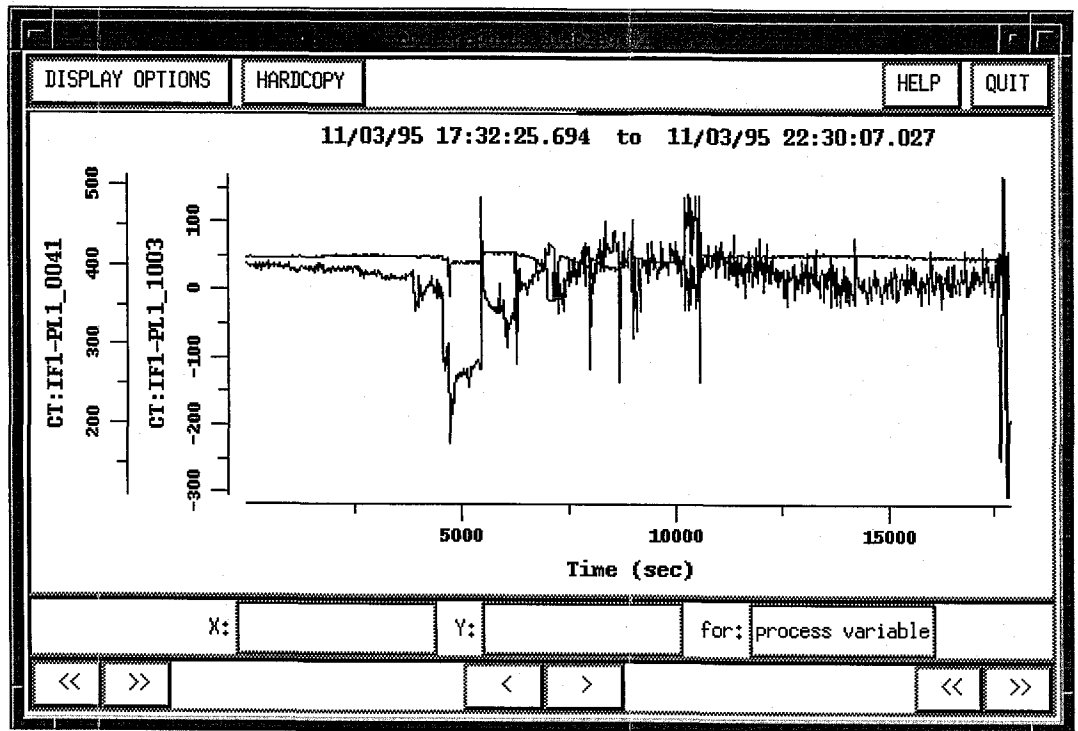
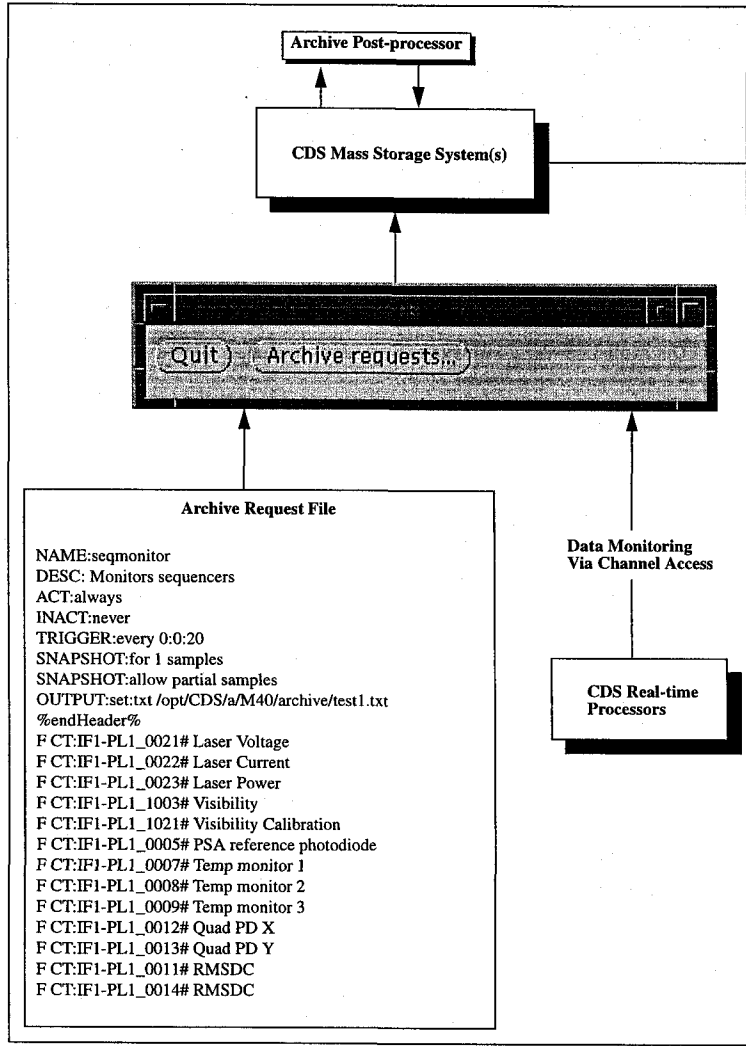

Appendix E - Figure 4
EPICS Data Archiver (AR)
and Retrieval (ARR) Tools

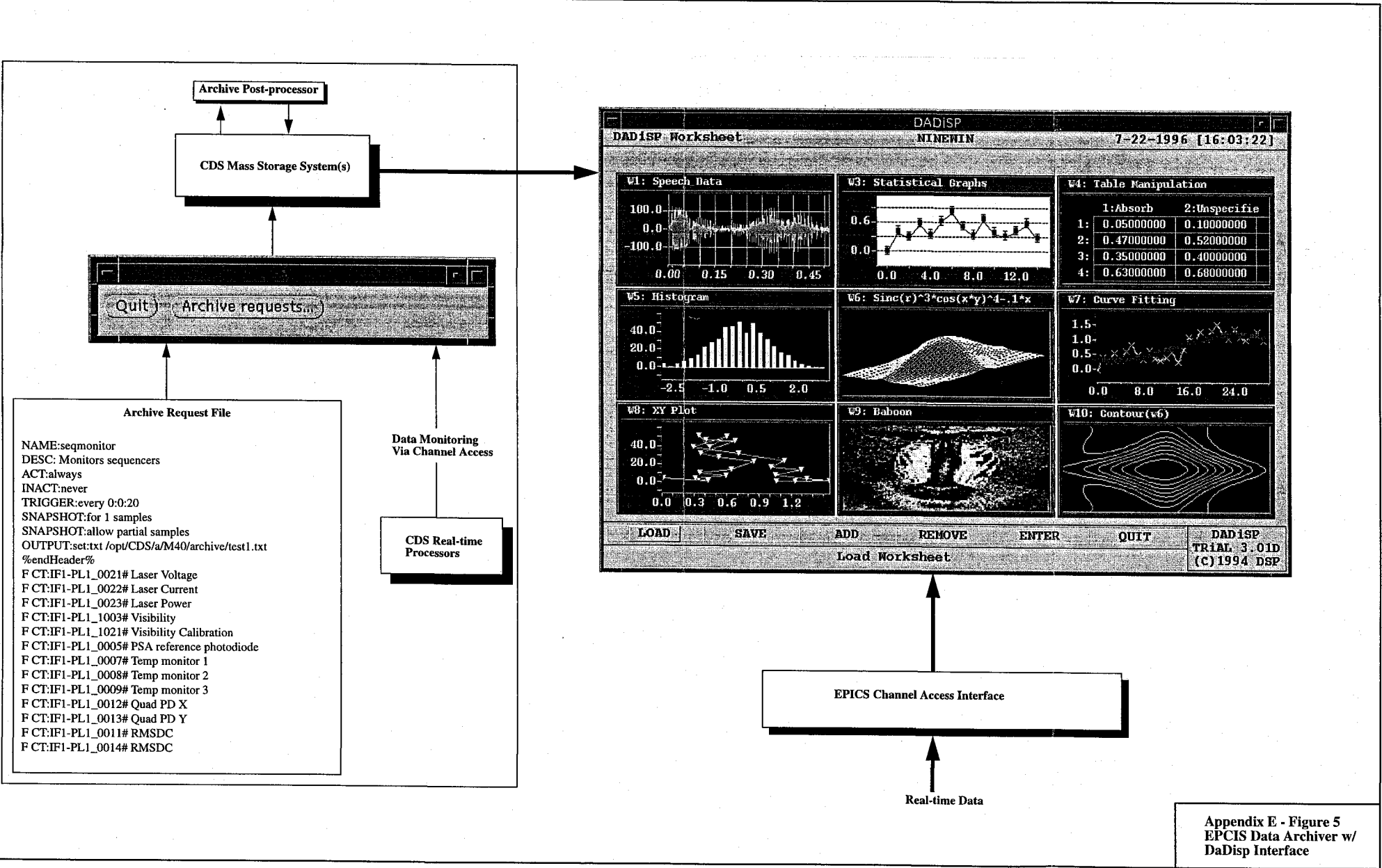

Appendix E - Figure 5
EPCIS Data Archiver w/
DaDisp Interface

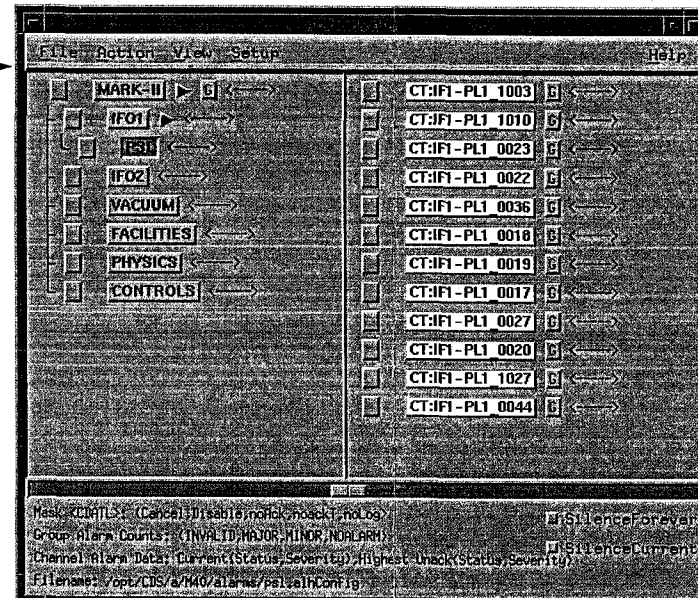
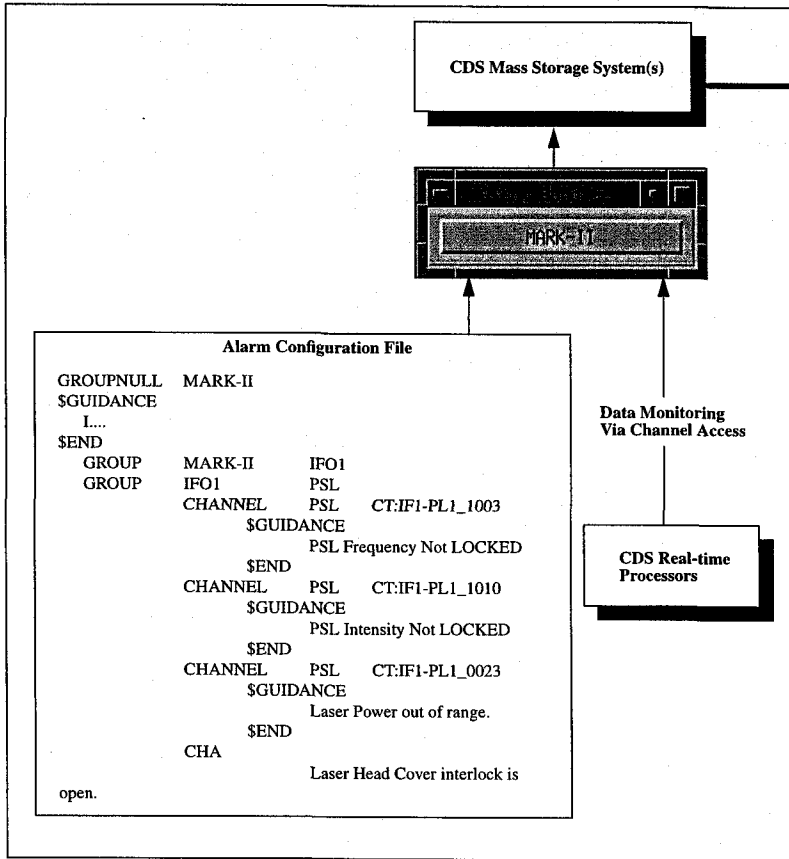

TIME STAMP	PROCESS VARIABLE NAME	CURRENT STATUS	HIGHEST ACK STATUS	VALUE
Mon Nov 20 09:45:13 1995	CT:IFO1-PL1_0027	STATE	MINOR	Low
Mon Nov 20 09:43:30 1995	CT:IFO1-PL1_0027	NO ALARM	NO ALARM	Normal
Mon Nov 20 09:40:01 1995	CT:IFO1-PL1_0027	STATE	MINOR	Low
Mon Nov 20 09:35:12 1995	CT:IFO1-PL1_0027	NO ALARM	NO ALARM	Normal
Mon Nov 20 09:32:43 1995	CT:IFO1-PL1_0027	STATE	MINOR	Low
Mon Nov 20 09:27:15 1995	CT:IFO1-PL1_0027	NO ALARM	NO ALARM	Normal
Mon Nov 20 09:14:15 1995	CT:IFO1-PL1_0027	STATE	MINOR	Low
Mon Nov 20 10:14:27 1995	CT:IFO1-PL1_0027	NO ALARM	NO ALARM	Normal
Mon Nov 20 10:20:53 1995	CT:IFO1-PL1_0027	STATE	MINOR	Low
Mon Nov 20 10:22:10 1995	CT:IFO1-PL1_0027	NO ALARM	NO ALARM	Normal
Mon Nov 20 10:27:43 1995	CT:IFO1-PL1_0027	STATE	MINOR	Low
Mon Nov 20 10:27:58 1995	CT:IFO1-PL1_0027	NO ALARM	NO ALARM	Normal
Mon Nov 20 11:21:10 1995	CT:IFO1-PL1_0027	STATE	MINOR	Low
Mon Nov 20 11:21:13 1995	CT:IFO1-PL1_0027	NO ALARM	NO ALARM	Normal
Mon Nov 20 11:27:44 1995	CT:IFO1-PL1_0027	STATE	MINOR	Low
Mon Nov 20 11:27:55 1995	CT:IFO1-PL1_0027	NO ALARM	NO ALARM	Normal
Mon Nov 20 12:10:46 1995	CT:IFO1-PL1_0027	STATE	MINOR	Low
Mon Nov 20 12:11:12 1995	CT:IFO1-PL1_0027	NO ALARM	NO ALARM	Normal
Mon Nov 20 12:22:19 1995	CT:IFO1-PL1_0027	STATE	MINOR	Low
Mon Nov 20 12:22:30 1995	CT:IFO1-PL1_0027	NO ALARM	NO ALARM	Normal
Mon Nov 20 12:45:54 1995	CT:IFO1-PL1_0027	STATE	MINOR	Low
Mon Nov 20 12:46:19 1995	CT:IFO1-PL1_0027	NO ALARM	NO ALARM	Normal
Mon Nov 20 13:06:40 1995	CT:IFO1-PL1_0027	STATE	MINOR	Low
Mon Nov 20 13:06:04 1995	CT:IFO1-PL1_0027	NO ALARM	NO ALARM	Normal

Appendix E - Figure 6
 EPICS Alarm Manager
 Software (ALH)

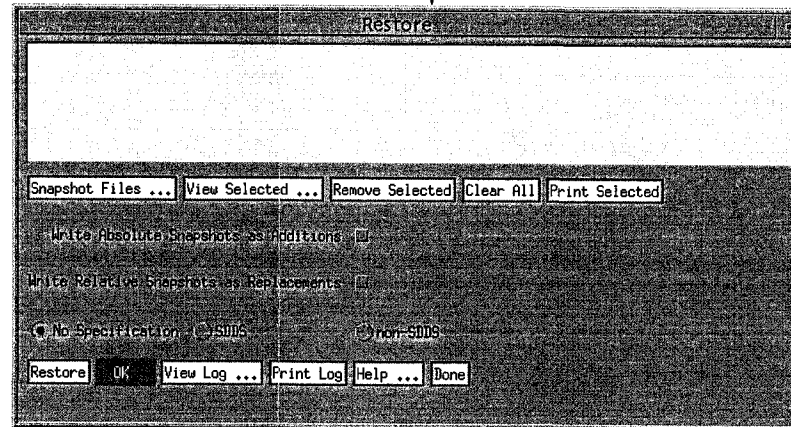
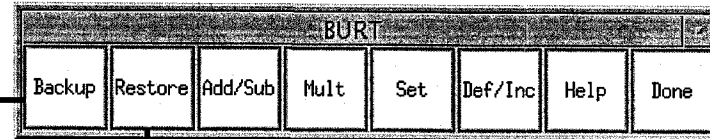
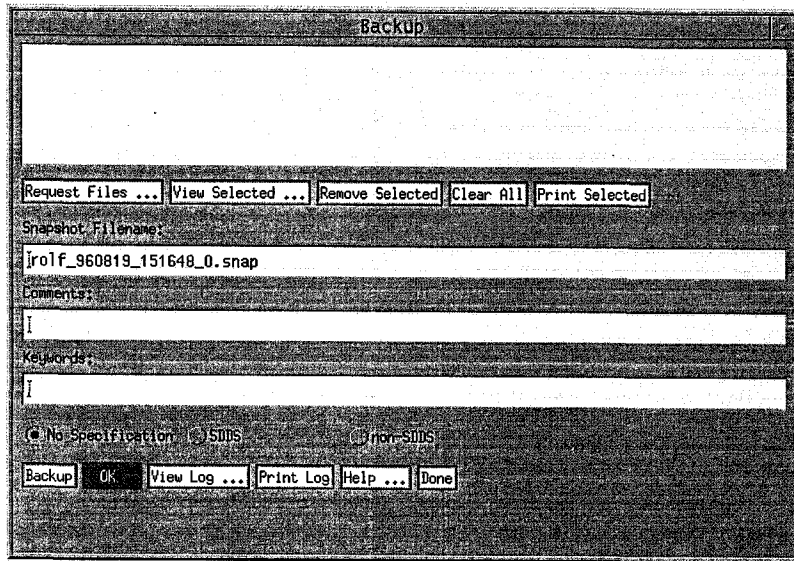

Appendix E - Figure 7
EPICS Backup and
Restore Tool (BURT)