



# **The Search for Gravitational Waves with LIGO: Status and Plans**

Peter Shawhan  
LIGO/Caltech

DPF2000  
August 10, 2000

# Gravitational Radiation

Gravitational radiation is a natural consequence of general relativity  
 Produced by massive systems with a time-varying quadrupole moment, *e.g.* a pair of neutron stars in a tight orbit  
 Far from the source, get “ripples in the curvature of spacetime” which may be viewed as quadrupole transverse waves

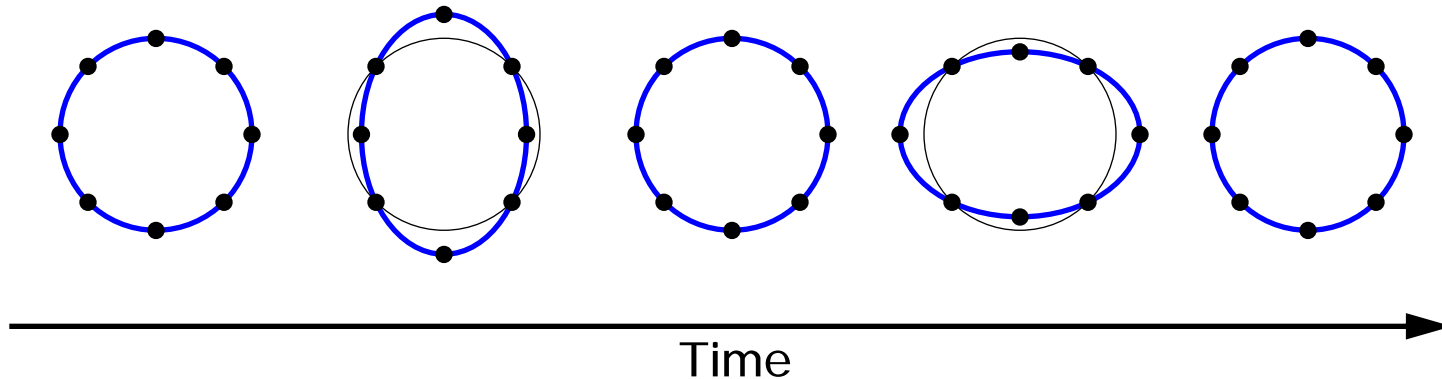

Gravitational waves have two polarization states

Dimensionless strain:  $h = \Delta L / L$  (typical value:  $10^{-21}$  !)

# Gravitational Wave Detectors

---

There is strong indirect evidence for gravitational radiation, from the gradual orbital decay of the binary pulsar PSR 1913+16, but not yet any direct detection

## Resonant “Bar” Detectors

- First built by Joseph Weber in the 1960s
- Watch for gravitational waves to excite a large metal bar at its resonant frequency
- Sensitive only to a narrow frequency band
- Several cryogenic detectors currently in operation in Italy, USA, and Australia
- Future plans: increase bandwidth (some), develop a spherical detector

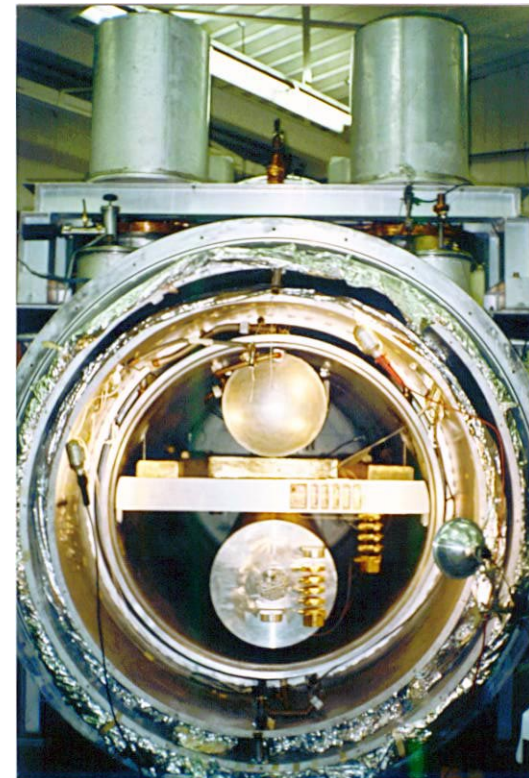

ALLEGRO detector at LSU

## Laser Interferometers

- Watch for differential length oscillation in two perpendicular arms
- Sensitive over a wide frequency range
- Prototypes have been built and operated, *e.g.* Caltech 40-meter
- Several large interferometers currently being built / commissioned:
  - TAMA (Japan, 300 m)
  - GEO (Germany, 600 m)
  - VIRGO (Italy, 3 km)
  - LIGO (Washington state, 4 km & 2 km; Louisiana, 4 km)

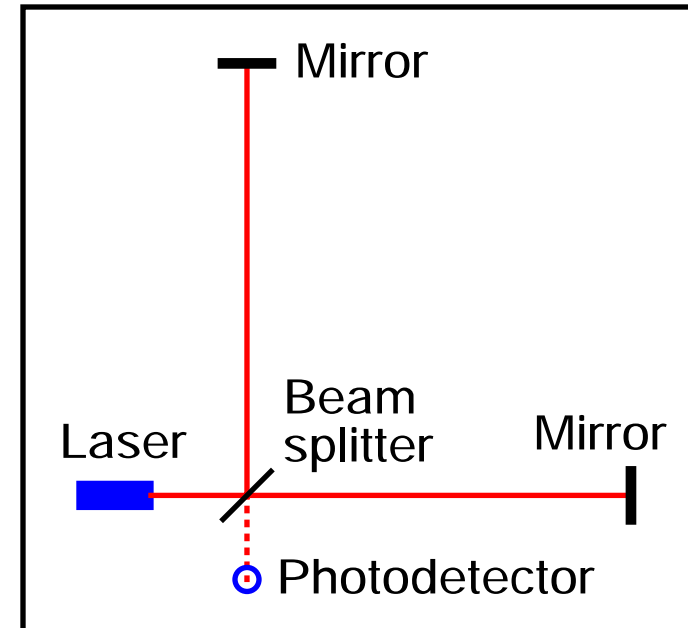

## Interferometer in Space: LISA

- Sensitive to much lower frequencies  $\Rightarrow$  different science goals
- Currently in mission planning stage; launch in ~2008 ?



# LIGO Organization

LIGO = Laser Interferometer Gravitational-Wave Observatory

## LIGO Scientific Collaboration

### LIGO Laboratory

Caltech  
MIT

LIGO Hanford Observatory  
LIGO Livingston Observatory

ACIGA (Australian Consortium)  
Caltech Center for Adv. Computing Research  
Caltech Relativity Theory Group  
Caltech Experimental Gravity Group  
Calif. State U., Dominguez Hills  
Carleton College  
Cornell U.  
U. of Florida  
GEO 600 Collaboration  
Institute of Applied Physics–Nizhny Novgorod  
JILA – U. of Colorado  
Louisiana State U.

Louisiana Tech U.  
U. of Michigan  
Moscow State U.  
National Astronomical Observatory of Japan  
U. of Oregon  
Penn. State U.  
Southeastern Louisiana U.  
Stanford U.  
Syracuse U.  
U. of Texas, Brownsville  
U. of Wisconsin, Milwaukee

Total of ~300 participants

Funded by the National Science Foundation

– Construction cost ~ \$300 million



# LIGO Hanford Observatory

Located on DOE Hanford Nuclear Reservation north of Richland, Washington



Brush fires swept across the LIGO site on June 28-29, but did no damage!



# LIGO Livingston Observatory

Located in a rural area of Livingston Parish east of Baton Rouge, Louisiana



## LIGO Beam Tubes

Made from stainless steel, treated to minimize H<sub>2</sub> outgassing

Diameter = 1.24 m, thickness = 3 mm, sections welded together

Baked at ~170 C by flowing ~2000 amps through tubes for a few weeks

Liquid nitrogen cryopumps now maintain pressure at a few x 10<sup>-8</sup> torr

Large gate valves allow interferometer optics to be installed / serviced without venting beam tubes

Beam tubes are protected by a concrete enclosure





# Optical Layout of LIGO Interferometers

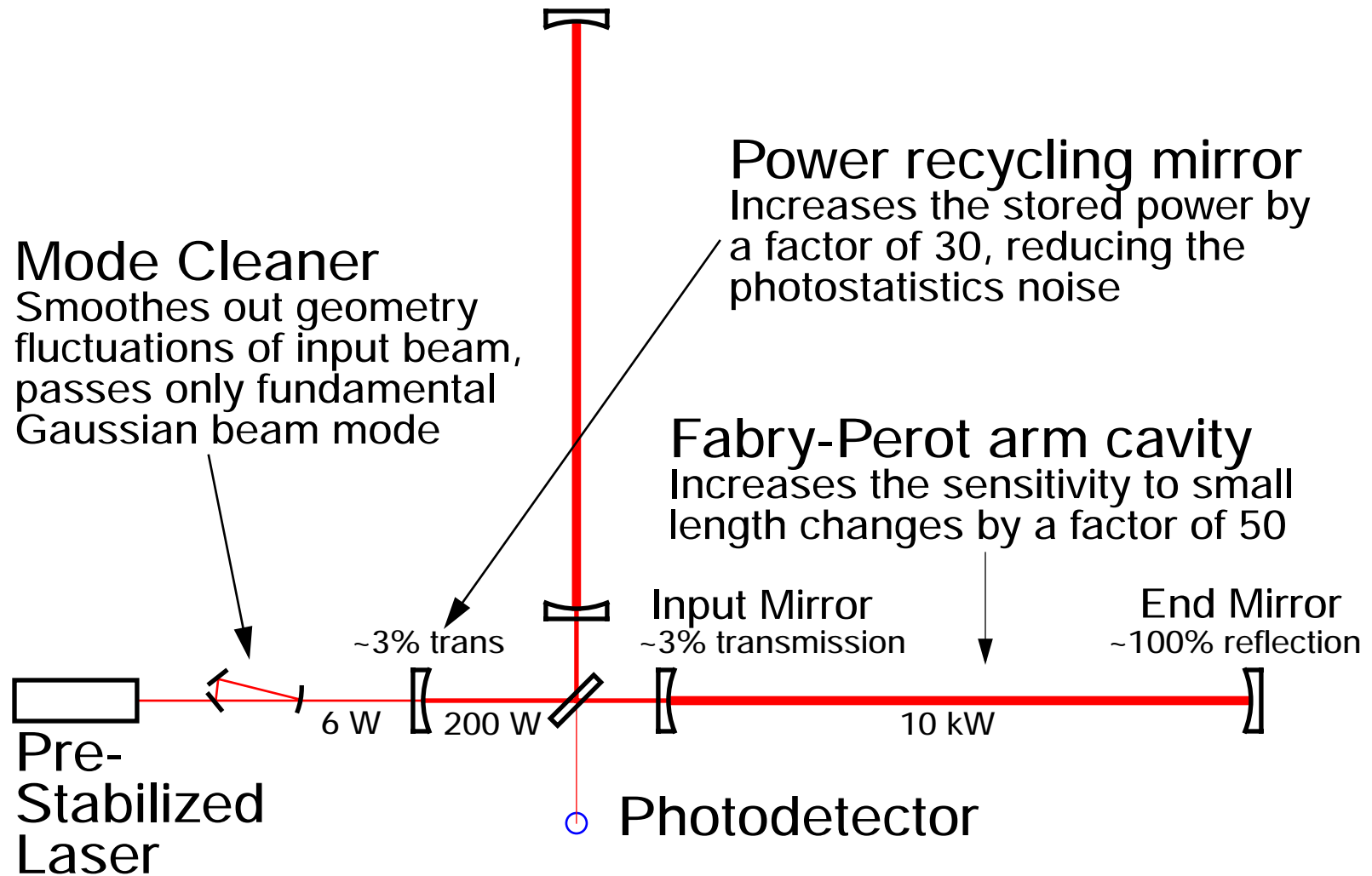

## Vacuum System in Vertex Region

At Hanford, the 4 km and 2 km interferometers have separate lasers and optical components, but share the arm beam tubes

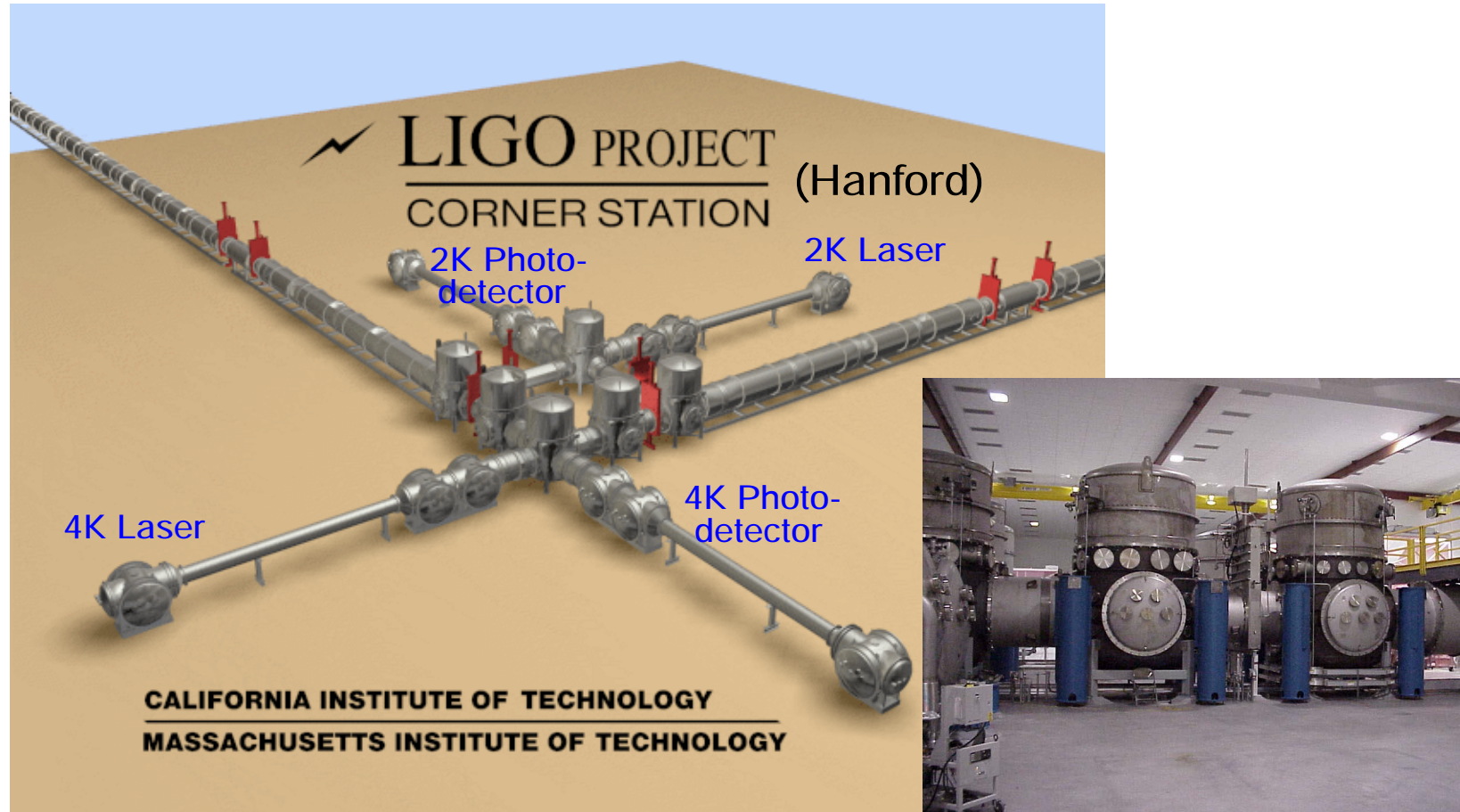

# LIGO Pre-Stabilized Laser

Based on a “commercial” Nd:YAG laser from Lightwave Electronics

- Master oscillator plus 8 amplification stages
- Wavelength = 1064 nm (infrared), power ~10 W

Uses additional sensors and optical components to locally stabilize the frequency and intensity

Final stabilization uses feedback from rest of interferometer

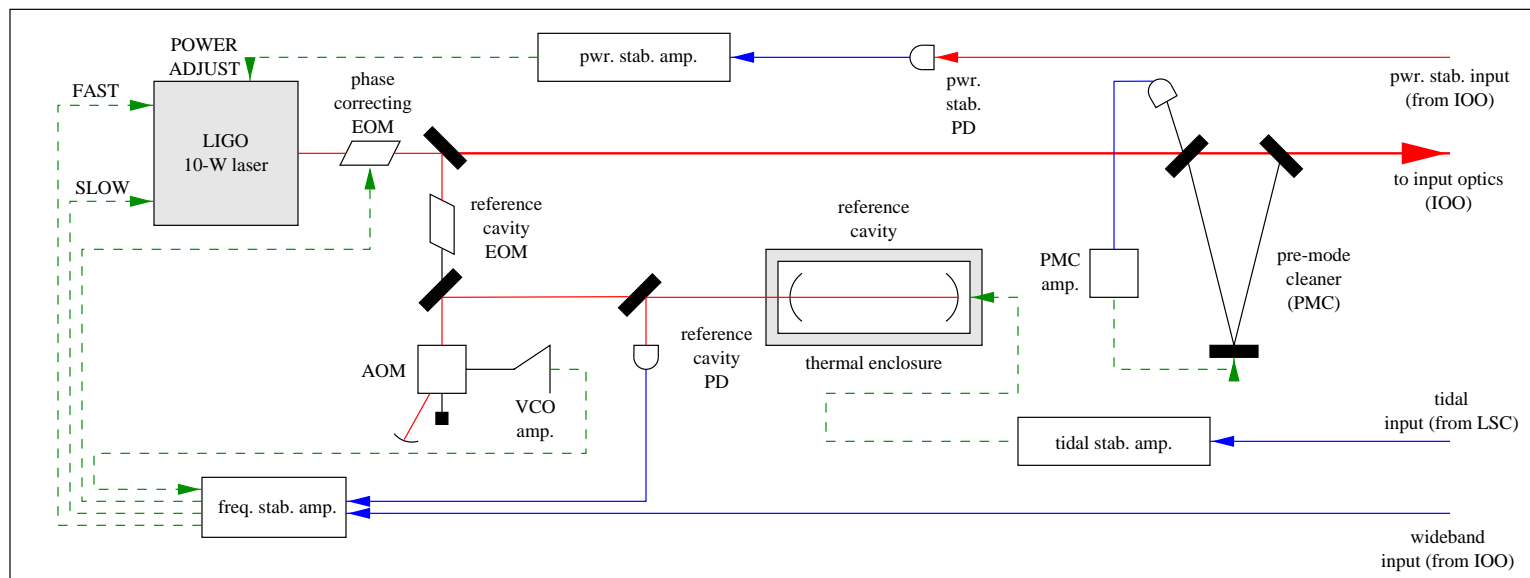

# LIGO Mirrors

- Fused silica with very low bulk absorption, high mechanical Q
- Largest mirrors are 25 cm diameter, 10 cm thick, 10.7 kg
- Surfaces polished to ~1 nm rms, some with slight curvature
- Extremely low scattering loss (<50 ppm)
- Suspended by a single steel wire each
- Actively aligned & positioned with magnets & coils

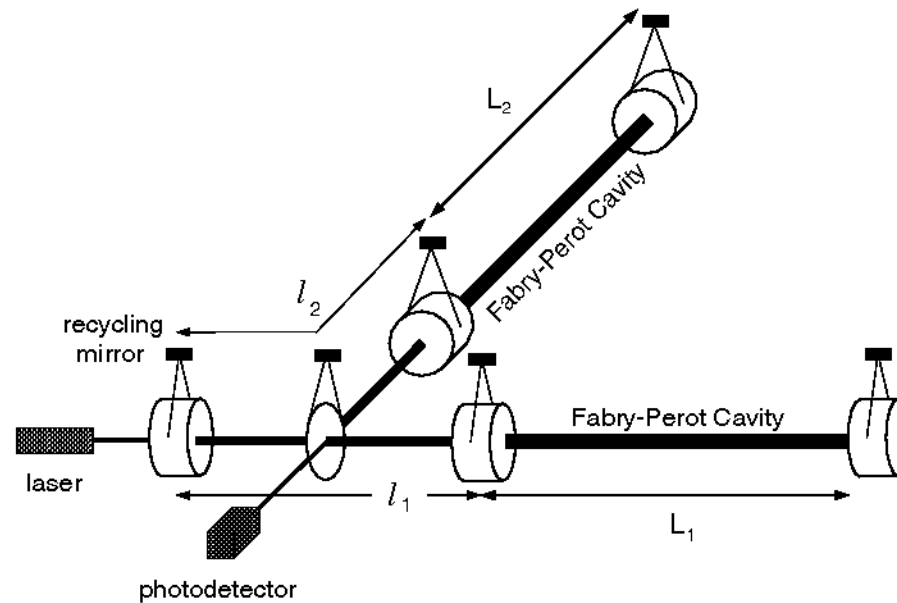

## A Mirror In Its Vacuum Tank



# Vibration Isolation

Optical table supports use a system of masses and damped springs

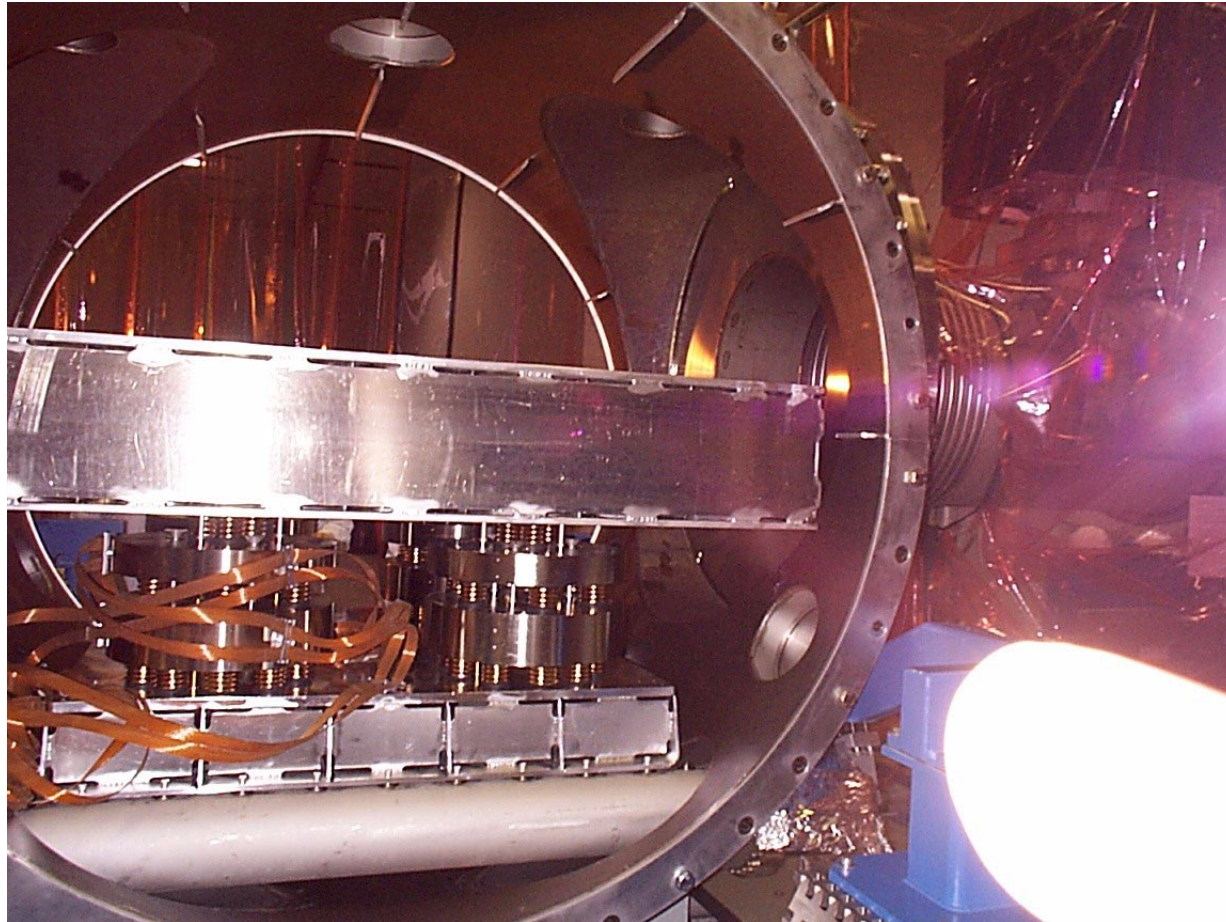

# Interferometer Controls

Servo control is the key to interferometer operation

Basic concept: “lock” interferometer by using feedback to keep it on a dark fringe, to within a small fraction of a wavelength

Subsystems interact, forming network

- Laser (frequency & intensity)
- Mode cleaner length
- Input beam alignment
- Alignment of large mirrors (uses several “wavefront sensors”)
- Cavity lengths, recycling mirror pos.

Custom-built analog & digital servos, computer-controlled via EPICS

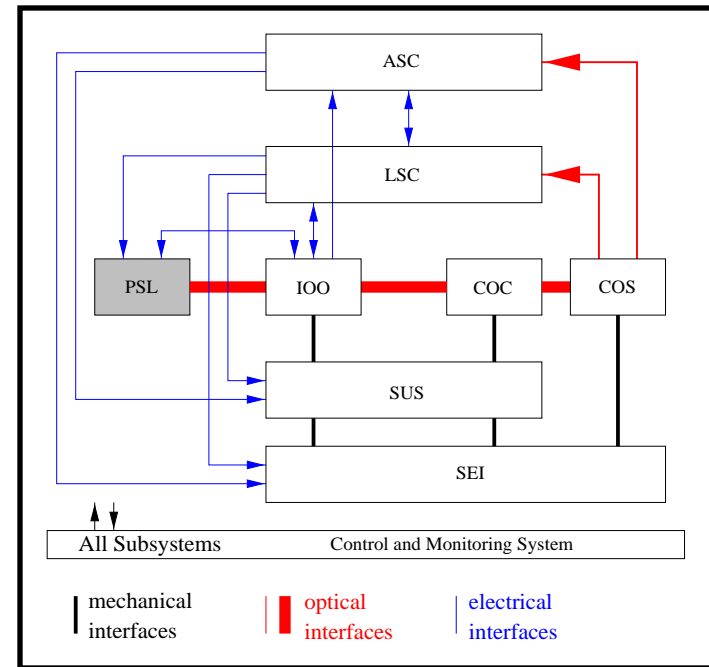

Modulate laser light at 3 frequencies to decouple degrees of freedom

Gravity-wave signal shows up as differential length-control servo effort



# Expected Strain Sensitivity vs. Frequency

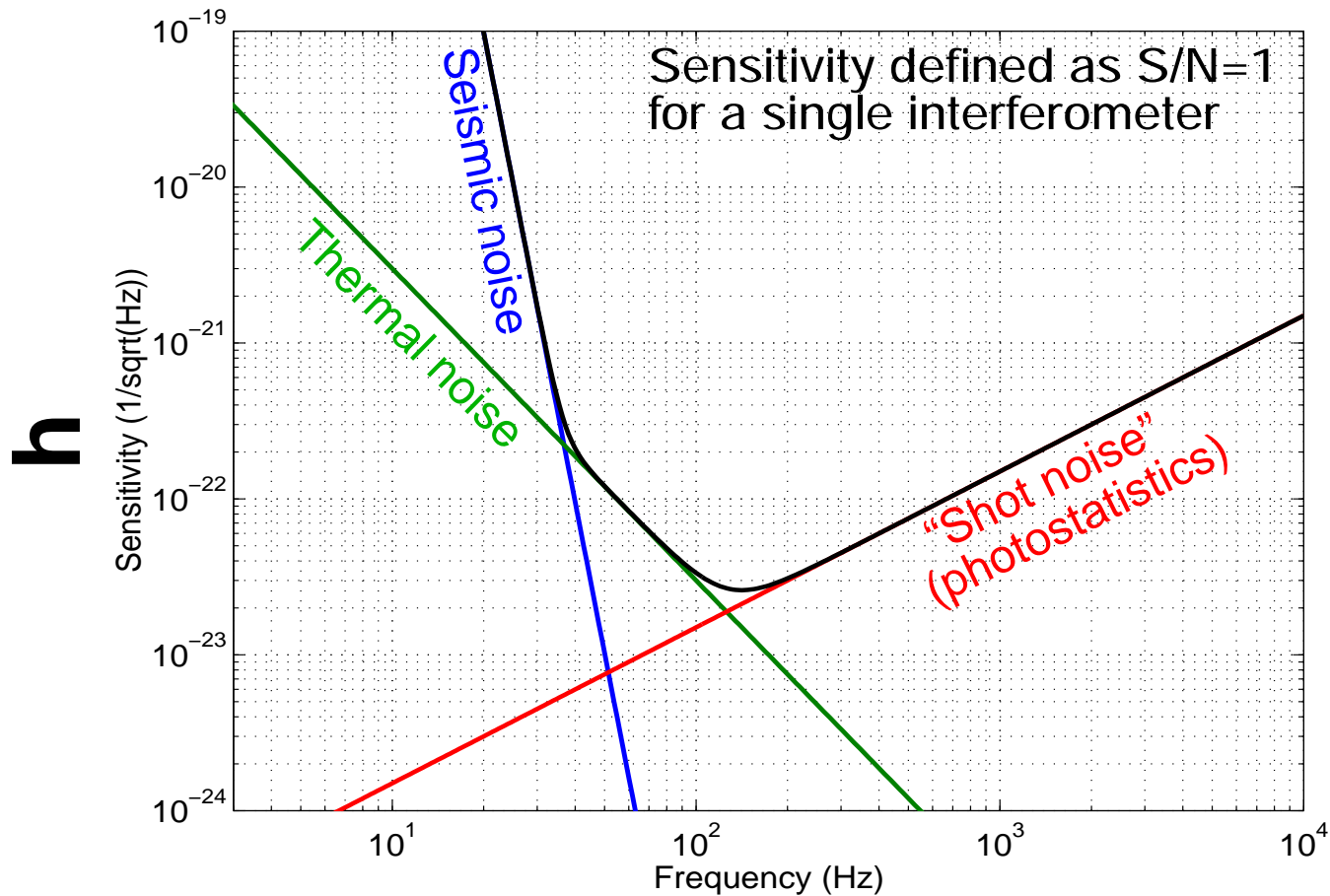

Not shown: narrow resonances from suspension wire vibrational modes; resonances outside of useful frequency range





# Gravitational-Wave Physics: Basic Science Goals

---

Make a direct observation! Coincidence capabilities of the LIGO interferometers are critical for this

Measure propagation speed (*i.e.* place limit on mass of graviton)

- By comparing arrival times at different detectors
- By correlating with a supernova or gamma-ray burst

Check quadrupole nature, *i.e.* place limit on scalar component

- Deduce by comparing strain patterns in interferometers with different orientations

After initial detection, start doing astrophysics

Plan to do a combined analysis with other interferometers (VIRGO, etc.)

- Improves sensitivity and confidence in small signals
- Allows source to be localized



# Gravitational Waves from Compact Binary Systems

Masses in tight orbit emit gravitational radiation, causing orbit to decay

A “standard” analysis for LIGO since the waveform and source strength are well known (until just before merging)

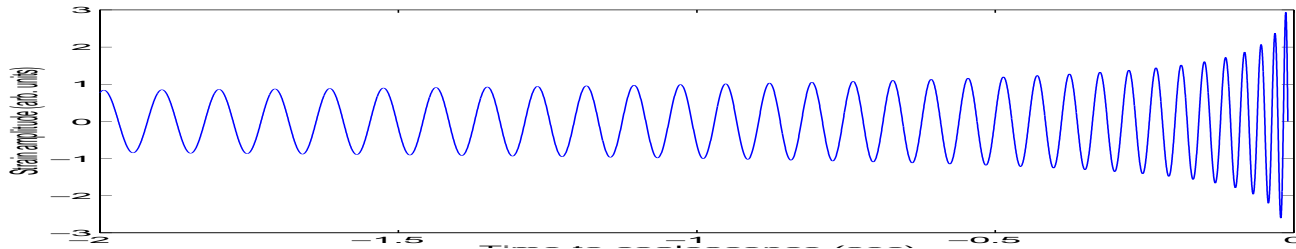

Use “matched filtering” to search for signals in noisy data

Two neutron stars

- A few systems known to exist
- LIGO reach:  $\sim 20$  Mpc (65 million light-years)
- Expected rate:  $\sim (10^{-3} - 1)$  event/year; best guess  $\sim 10^{-2}$

Black hole and neutron star *or* Two black holes

- Larger signal amplitude  $\Rightarrow$  farther reach
- No examples known  $\Rightarrow$  rates uncertain, but likely to be significantly higher than NS-NS



## Other Potential Sources of Gravitational Waves

---

Ringdown of newly formed black hole

- Damped sinusoid

Supernova (depends on asymmetry of explosion)

“r-mode” oscillation of young neutron star

- Instability driven by gravitational radiation
- Decay time is of order 1 year

Asymmetric, rapidly-spinning neutron star

- Crust may be able to support inhomogeneities, particularly if its temperature is elevated by accretion (as in a low-mass X-ray binary)
- Can integrate for a long time, correcting for earth’s motion
- Track known pulsars, or search entire sky (CPU-intensive)

Stochastic gravitational-wave background from early universe

- Detectable in some non-standard models (strings, etc.)
- Shows up as correlated noise in different interferometers



## Data Acquisition

---

Each interferometer produces one gravitational-wave channel, continuously sampled at 16384 Hz, plus hundreds of auxiliary and environmental channels

- Laser monitoring channels
- Servo inputs and outputs
- Suspension controller coil currents
- Alignment system raw signals
- Seismometers, accelerometers, microphones
- Magnetometers, temperatures, wind speed & direction

These “extra” channels are used to study the performance of the interferometer and to reject events caused by environment or instrument

Total data rate for 3 interferometers ~10 MB/sec (100 kB/sec GW data)

Data to be archived: ~100 TB/year

# LIGO Data Analysis System

Unified system consisting of various software components running on many computers connected to a high-bandwidth network

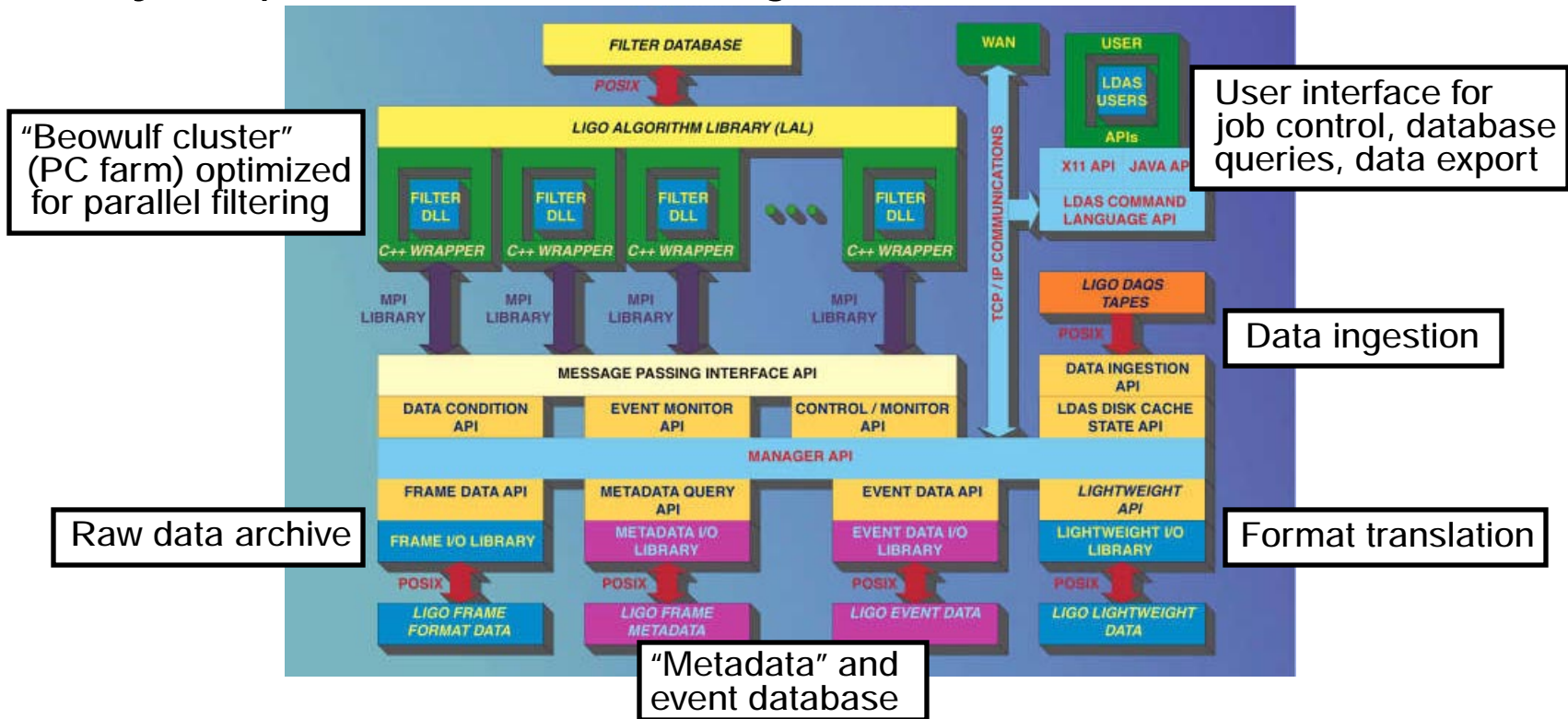

Installations at Hanford & Livingston (for online event searches) plus one or more offline analysis centers; main raw data archive at Caltech



## Some Recent Milestones

---

May 1999	Hanford	Beam tube bakeout complete
June 1999	Hanford	Mode cleaner locked
Dec 1999	Hanford	First light along 2 km arm cavity
Dec 1999	Hanford	Single arm locked (briefly at first, then longer)
Mar 2000	Livingston	Mode cleaner locked
Apr 2000	Hanford	"Engineering data run" with single arm locked
May 2000	Livingston	Beam tube bakeout complete
May 2000	Hanford	All in-vacuum installation complete for 2 km
July 2000	Hanford	"Vertex Michelson interferometer" locked
Aug 2000	Hanford	2 km interferometer installation complete
Aug 2000	Livingston	Mode cleaner commissioning complete



## Current Activities and Schedule

---

Some current Activities:

- Studies of environmental transients (earthquakes, airplanes, ...)
- Suspension debugging and tuning
- Servo evaluation and modification (switching to digital servos)
- Comparing detector behavior against end-to-end simulation
- Preparation for full interferometer configuration

Projected Schedule:

Oct 2000	Livingston	Interferometer installation complete
Nov 2000	Hanford 4K	All in-vacuum installation complete
Dec 2000	Hanford 2K	Full interferometer locked
Feb 2001	Livingston	Full interferometer locked
Apr 2001	Hanford 4K	Interferometer installation complete
Apr 2001	H2 + L	Coincidence engineering runs begin
Aug 2001	Hanford 4K	Full interferometer locked
Jan 2002	H2+H4 + L	Begin science run
Jan 2005		End LIGO I science run

## Planning for LIGO II

---

A reference design, resulting from ongoing R&D, has been formulated:

- Increase laser power to 180 W
- Increase mirror mass to 30 kg; probably switch to sapphire
- Add active compensation for thermal lensing in input mirrors
- Improve vibration isolation with new active & passive stages
- Redesign mirror suspension (multiple pendulum stages, silica fibers)
- Electrostatic actuation for mirror alignment & positioning
- Add a “signal recycling mirror” to enhance signal extraction; also provides some frequency tunability
- Add a mode cleaner at the output port

Expect to achieve a factor of 10 better sensitivity than LIGO I  
⇒ a factor of 1000 in event rate!

Currently seeking project approval and funding

Plan to install / commission in 2005-6, begin running in 2007





## Summary

---

Construction of the LIGO observatories was a great success

Installation is nearly complete for two of the three interferometers

Commissioning is progressing, with no serious setbacks

⇒ After many years of preparation, LIGO is poised to begin operation!

The initial LIGO detectors may need a little luck to observe gravitational waves, *if* the current predictions are to be believed and there is no “new astrophysics”

LIGO II promises a dramatic increase in sensitivity

There are even ideas for “LIGO III”...

⇒ Exciting times ahead!