

Study of Cavity Field Dynamics at High Frequencies with the H1 Interferometer

R. Savage

LIGO Hanford Observatory, Richland

M. Rakhmanov

University of Florida, Gainesville

*LIGO Scientific Collaboration Meeting
LIGO Livingston Observatory, Livingston, LA*

Introduction

Motivation:

- detection of $h(t)$ requires measurement of $E(t)$
- 4-km Fabry-Perot cavities are dynamical systems
- verify time-domain models (E2E, Siesta)
- verify frequency-domain models (Twiddle, Finesse)
- test fundamental equations for field dynamics
- extract parameters: FSR, cavity length, demod. phase
- monitor long term variation of the arm cavity length
- detect stochastic g.w. at FSR (Univ. of Rochester)

Related documents:

- J. Mason, M. Regehr and H. Yamamoto, Twiddle – a program for analyzing interferometer frequency response, LIGO T990022
- D. Sigg, et al., Frequency response of the LIGO interferometer, LIGO T970084
- F. Bondu, Virgo Injection System, Virgo tech. note

Field Dynamic Effects

Cavity field dynamics in time domain:

$$E(t) = t_a A e^{i\psi(t)} + r_a r_b e^{-2ikL(t)} E(t - 2T),$$

phase ψ and length L can be excited.

Periodic excitation causes variations in the field:

$$E(t) = \bar{E} + \delta E(t),$$

which are measured by the Pound-Drever-Hall signal:

$$\delta V(t) = \text{Im}\{\delta E(t)\}.$$

Cavity responses:

$$H_\omega(s) = \frac{\delta V(s)}{\delta \omega(s)}, \quad H_L(s) = \frac{\delta V(s)}{\delta L(s)}.$$

Theoretical prediction:

$$H_L(s) = e^{sT} \prod_{n=-\infty}^{\infty} \frac{p_n}{p_n - s},$$
$$H_\omega(s) = \frac{p_0}{p_0 - s} \prod_{n=-\infty}^{\infty} \frac{p_n(z_n - s)}{z_n(p_n - s)}.$$

The zeros and poles are

$$z_n = 2\pi i \text{FSR } n, \quad p_n = z_n - \frac{1}{\tau},$$

where $\tau = 1.75$ ms is the storage time.

(for details see Phys. Lett. A305 (2002) pp. 239-244)

Outline of the Experiment

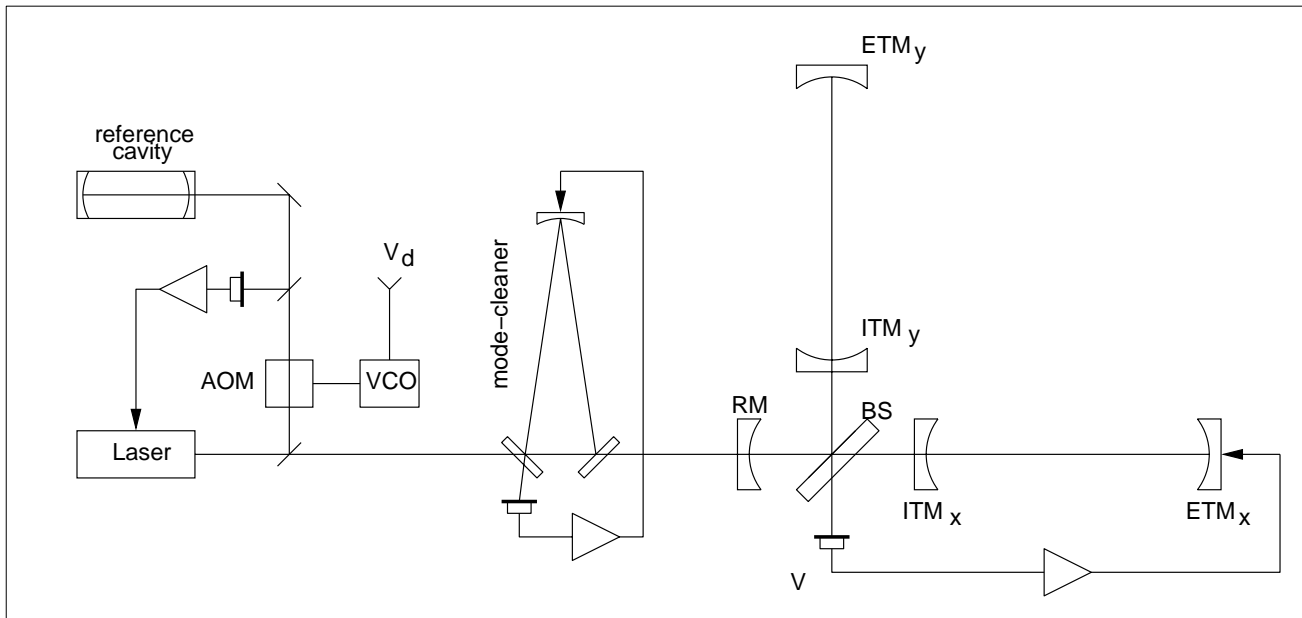

$\delta V_d(s)$ sine-wave to VCO \rightarrow AOM offsets the light frequency by $\delta\omega(s) = \delta V_d(s)$. The PSL servo produces an error-correction signal and forces the laser to shift its frequency by the same amount (in the opposite way):

$$\delta\omega'(s) = \frac{G(s)}{1 + G(s)} \delta V_d(s),$$

$G(s)$ is the PSL loop gain. For large gain, $\delta\omega'(s) \approx \delta\omega(s)$.

$\delta V(s)$ – variations in the PDH-signal

$$\frac{\delta V(s)}{\delta V_d(s)} = \frac{\delta V(s)}{\delta\omega(s)} \frac{\delta\omega(s)}{\delta V_d(s)} \approx H_\omega(s).$$

Transfer Function $H_{\omega}(s)$

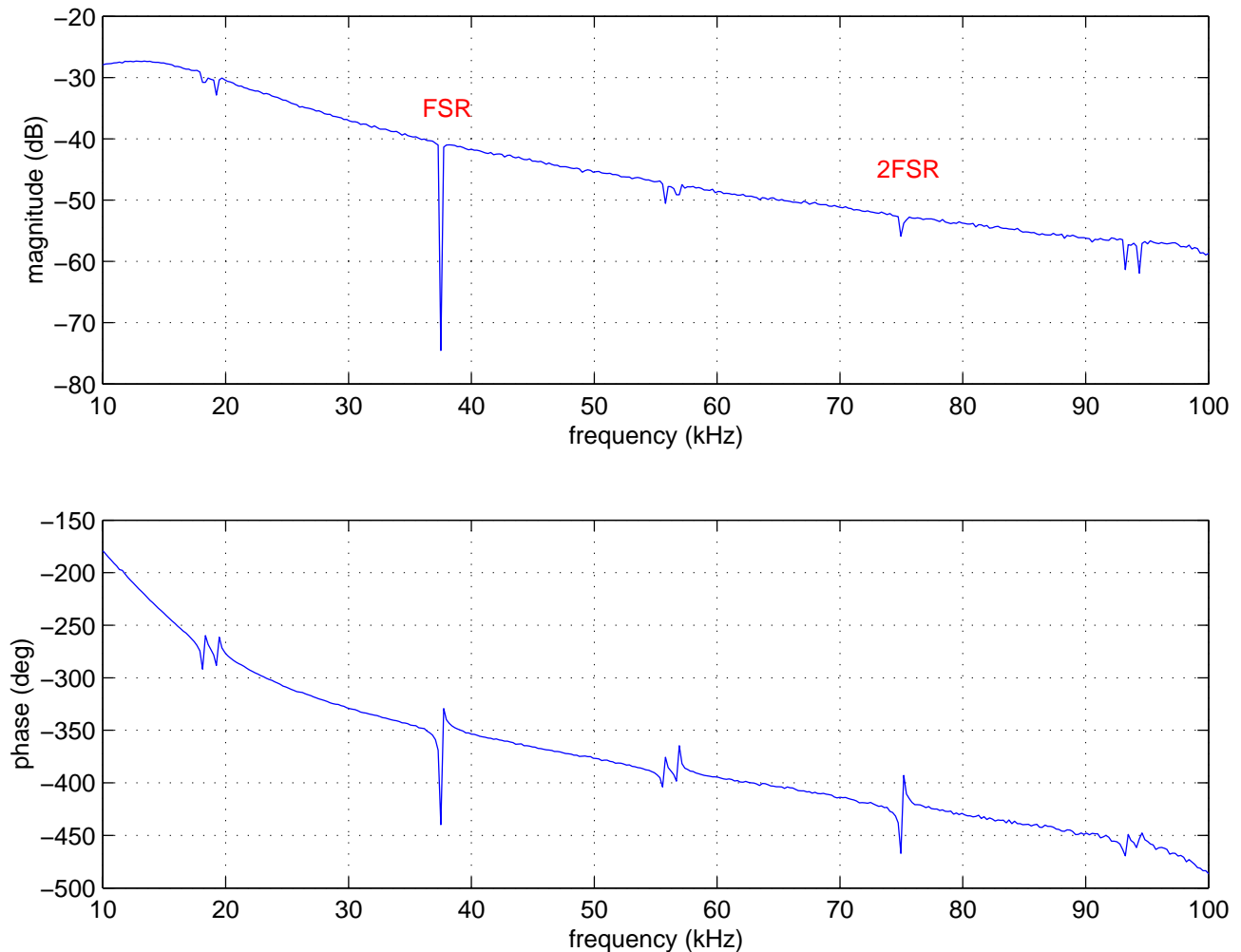

excitation: laser frequency of H1 interferometer

drive method: inject a sine-wave to VCO and rely on the PSL open-loop gain ($f < \text{UGF}$)

sensing: AS_Q and AS_I channels

Location of Resonances

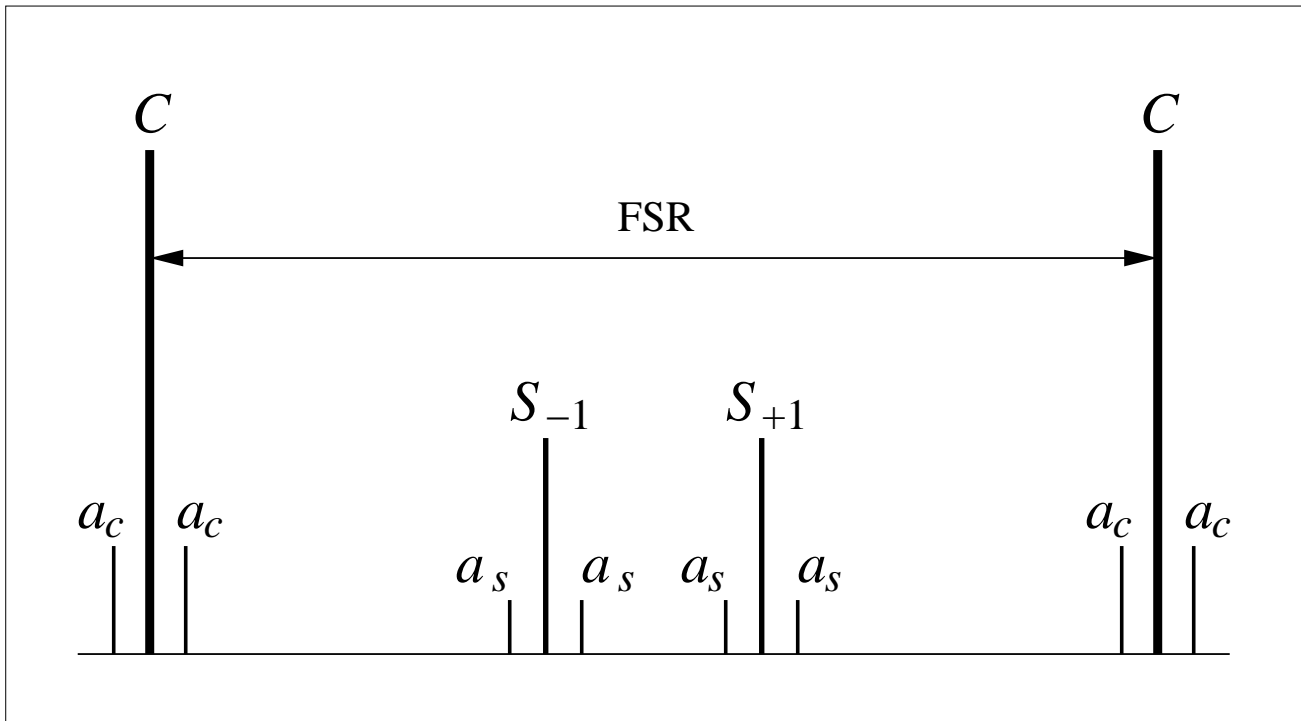

Modulation of the laser frequency = audio sidebands.

a_c – audio sidebands on the carrier,

a_s – audio sidebands on the RF-sidebands.

The resonances occur when either a_c or a_s run over FSR.

Mathematically, a_c and a_s can be described as field perturbations $\delta E(t)$ which evolve in time according to the time-domain iteration algorithm.

Carrier Cusp (1-Hz Span)

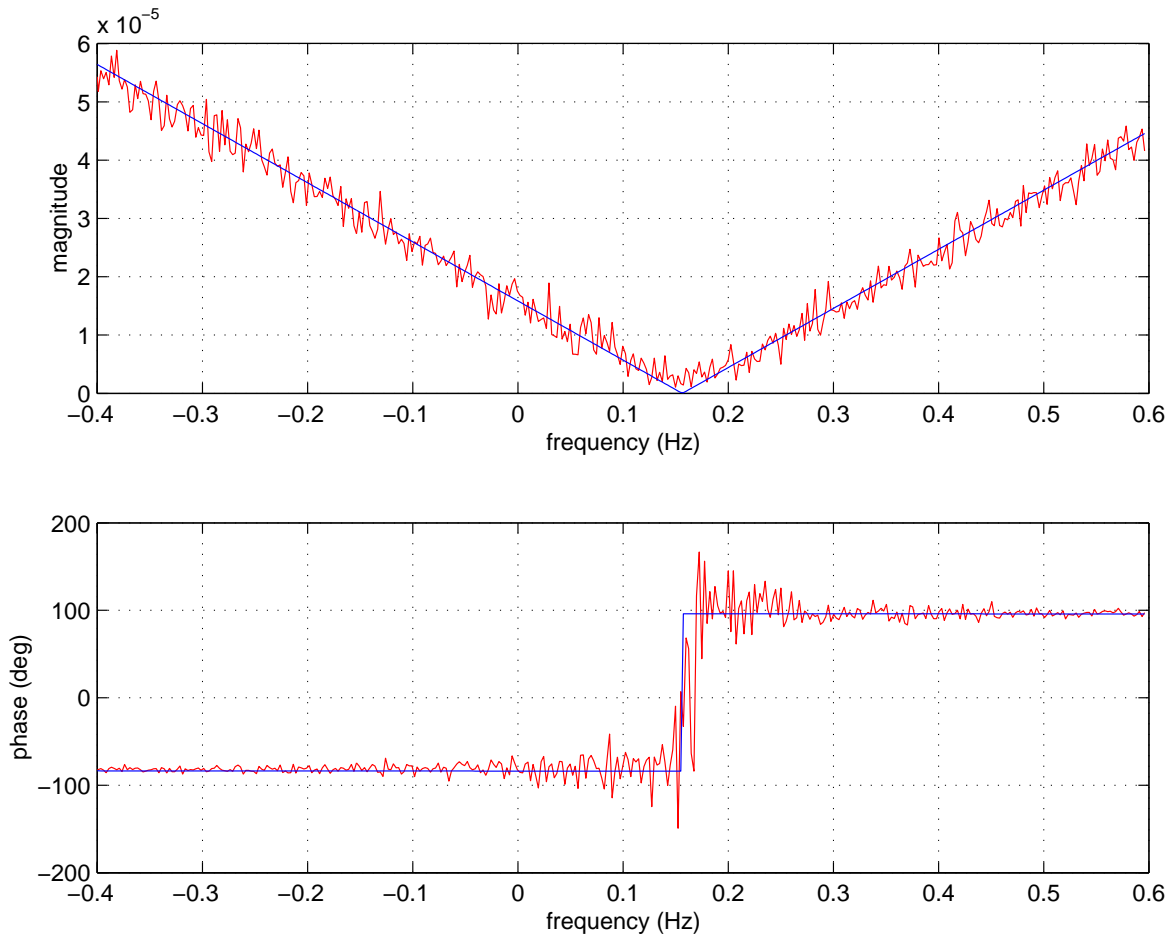

horizontal axis: $x = f - f_c$, where $f_c = 37520$ Hz.

LSQ fit yields the FSR and the length:

$$f_0 = 37520.1577 \text{ Hz,}$$

$$L = 3995.08526 \text{ m.}$$

The errors are

$$\delta f_0 = 0.0013 \text{ Hz,}$$

$$\delta L = 0.00014 \text{ m.}$$

Carrier Cusp (100-mHz Span)

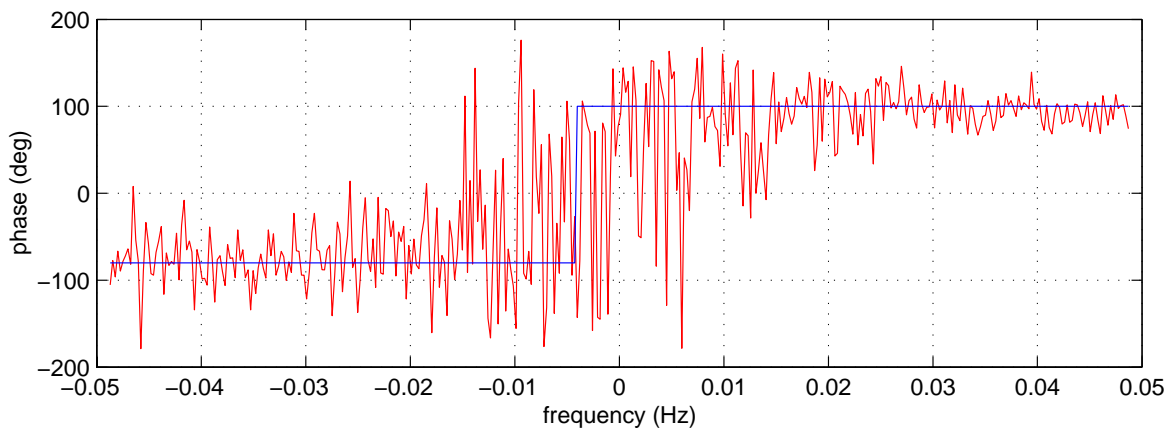
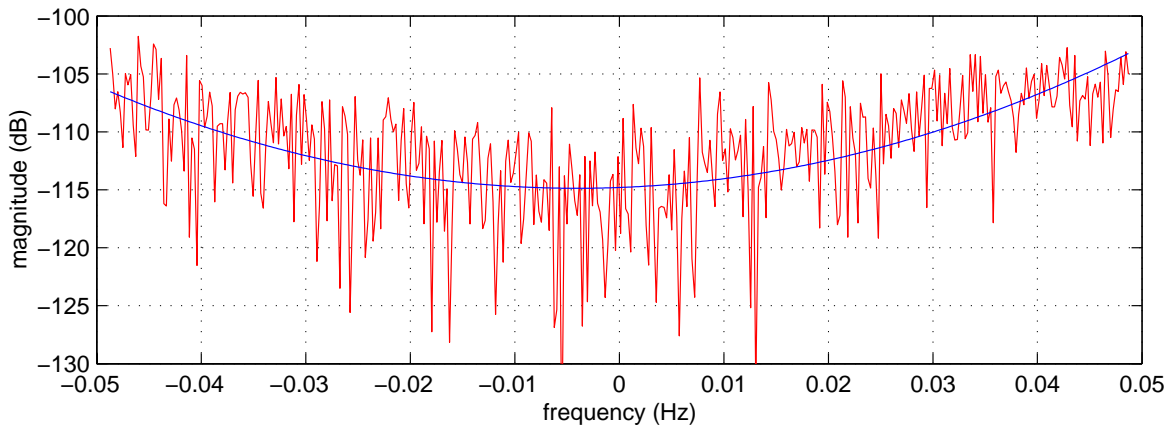

horizontal axis: $x = f - f_c$, where $f_c = 37520.164237$ Hz.

LSQ fit yields the FSR and the length:

$$\begin{aligned} f_0 &= 37520.1602 \text{ Hz,} \\ L &= 3995.084996 \text{ m.} \end{aligned}$$

The errors are

$$\begin{aligned} \delta f_0 &= 0.0011 \text{ Hz,} \\ \delta L &= 0.00012 \text{ m.} \end{aligned}$$

Sideband Resonances (AS_I)

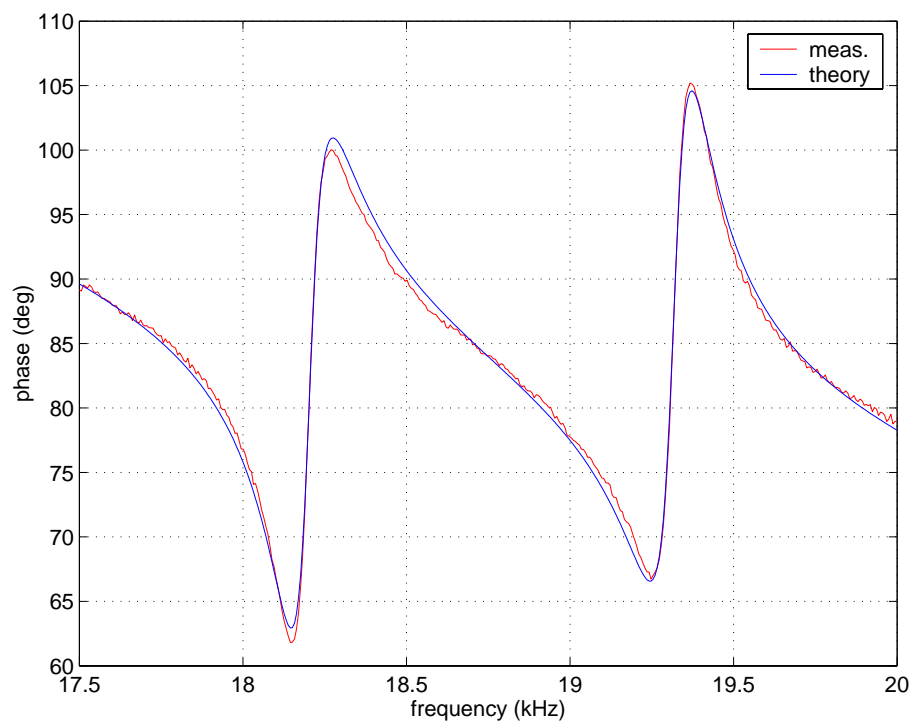
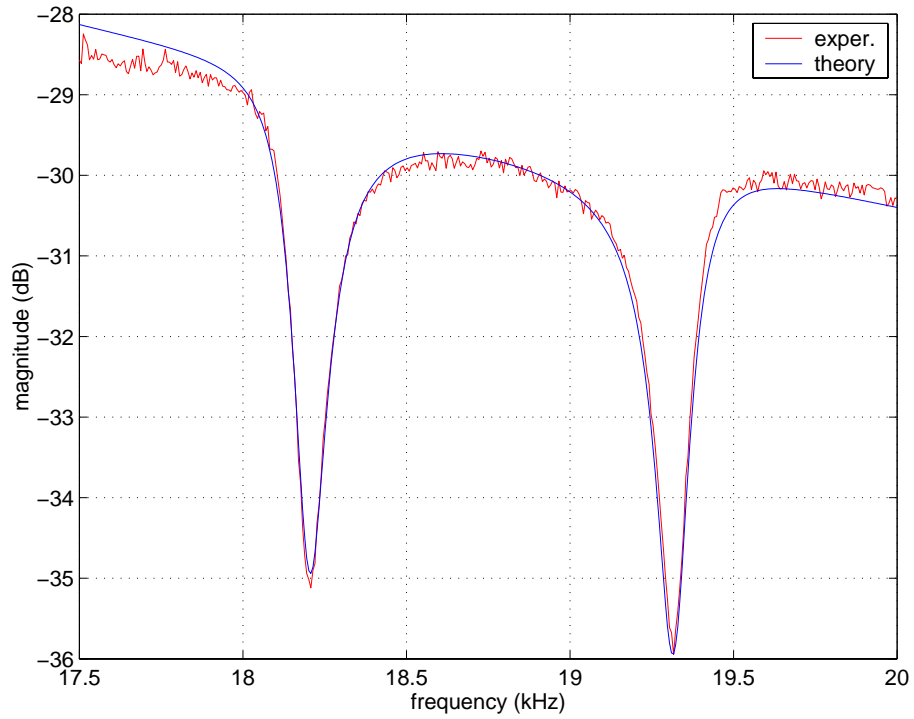

Sideband Resonances (AS_Q)

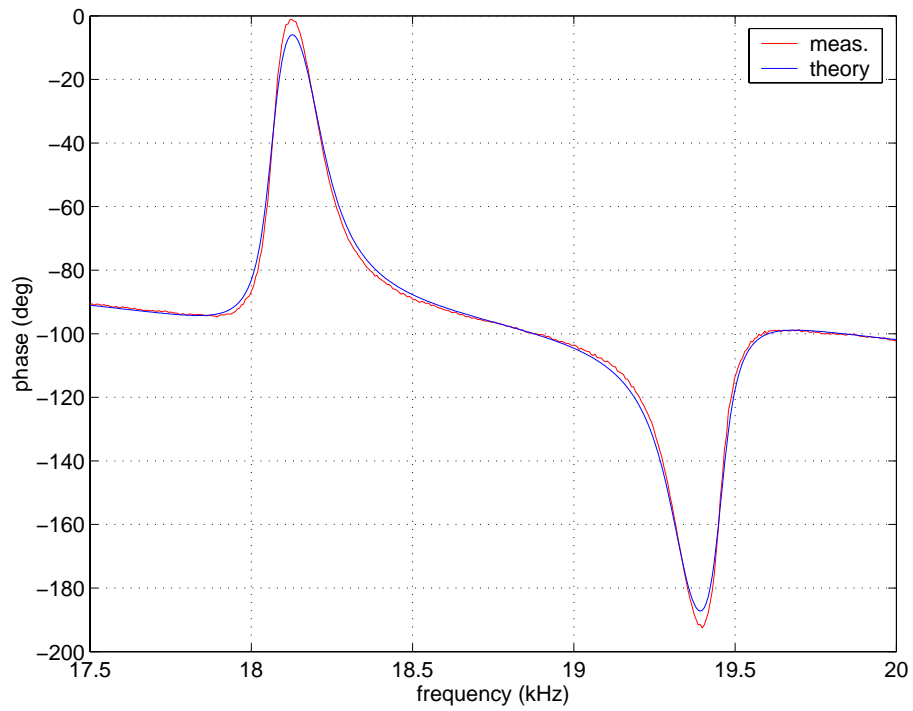
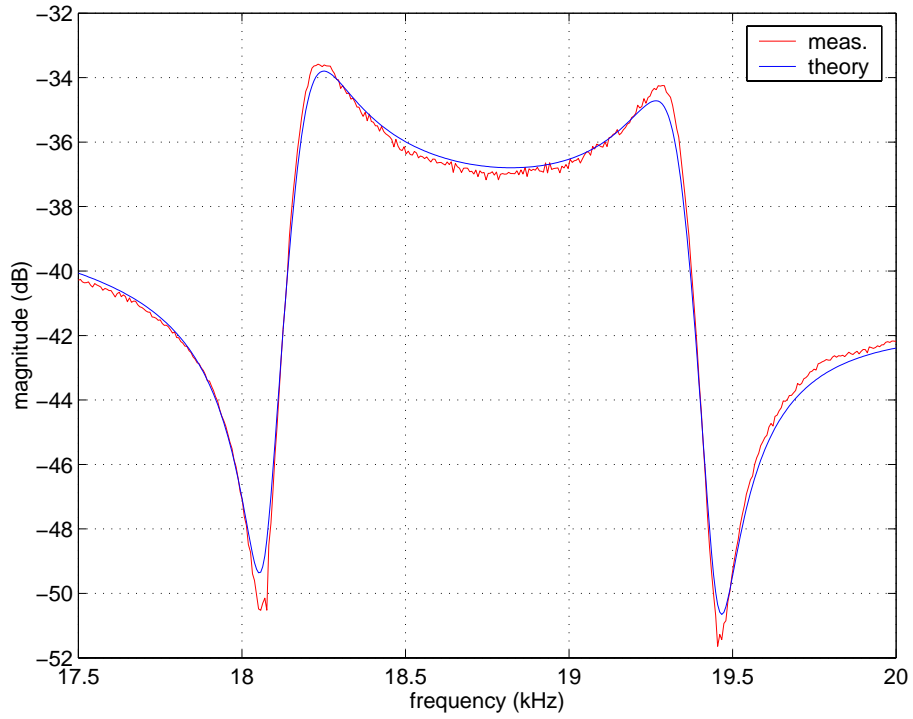

Measurement of H1 X-arm Length

Modulation frequency

$$f_{\text{mod}} = 24481326 \text{ Hz},$$

measured with the rubidium frequency standard.

Summary of the length measurements:

carrier cusp (1-Hz span):

$$L = 3995.08526 \text{ m},$$

carrier cusp (0.1-Hz span):

$$L = 3995.08500 \text{ m},$$

sideband dips (AS_I):

$$L = 3995.08675 \text{ m},$$

$$L = 3995.08665 \text{ m},$$

sideband dips (AS_Q):

$$L = 3995.08634 \text{ m},$$

$$L = 3995.08640 \text{ m}.$$

The sideband dips yield two independent length measurements: one from the magnitude fit, another from the phase fit.

Correction to the frequency array produced by SRS spectrum analyzer is 0.404 Hz.

Transfer Function $H_L(s)$

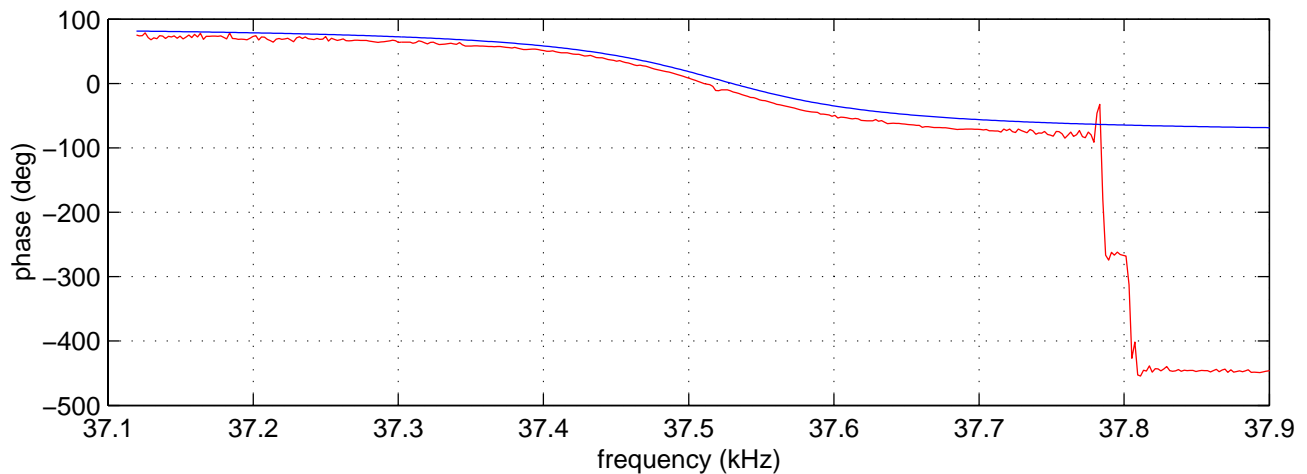
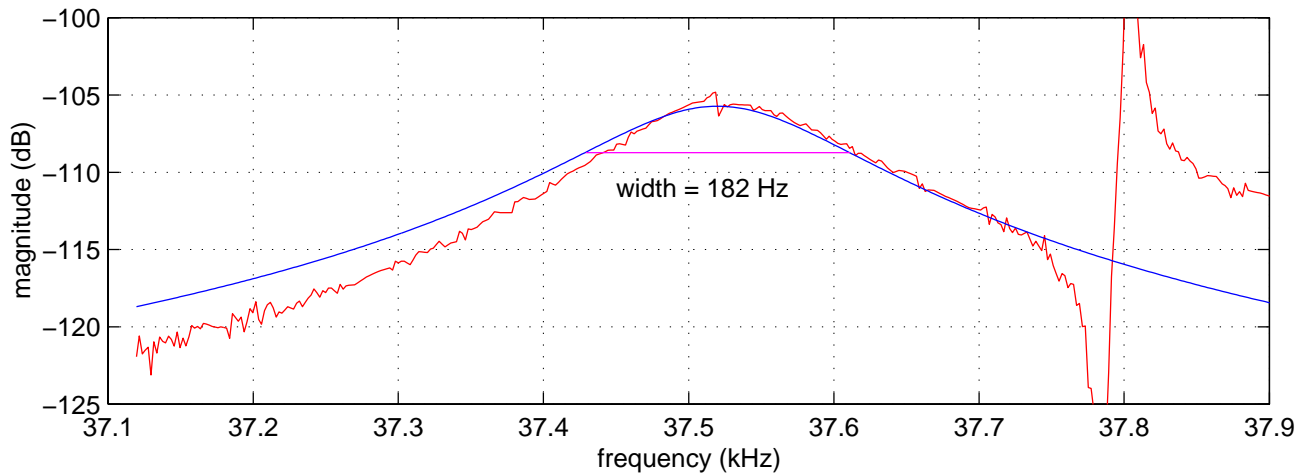

excitation: input test mass of H1 interferometer

drive method: inject a sine-wave into suspension control module and rely on absence of the length control gain ($f > \text{UGF}$)

sensing: standard AS_Q channel

Effect of Asymmetry on $H_L(s)$

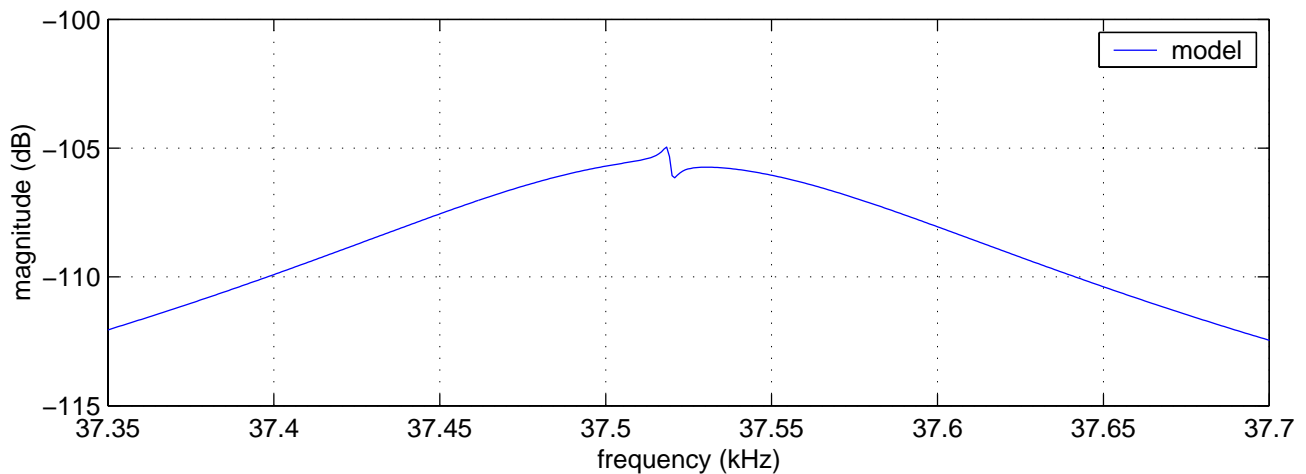
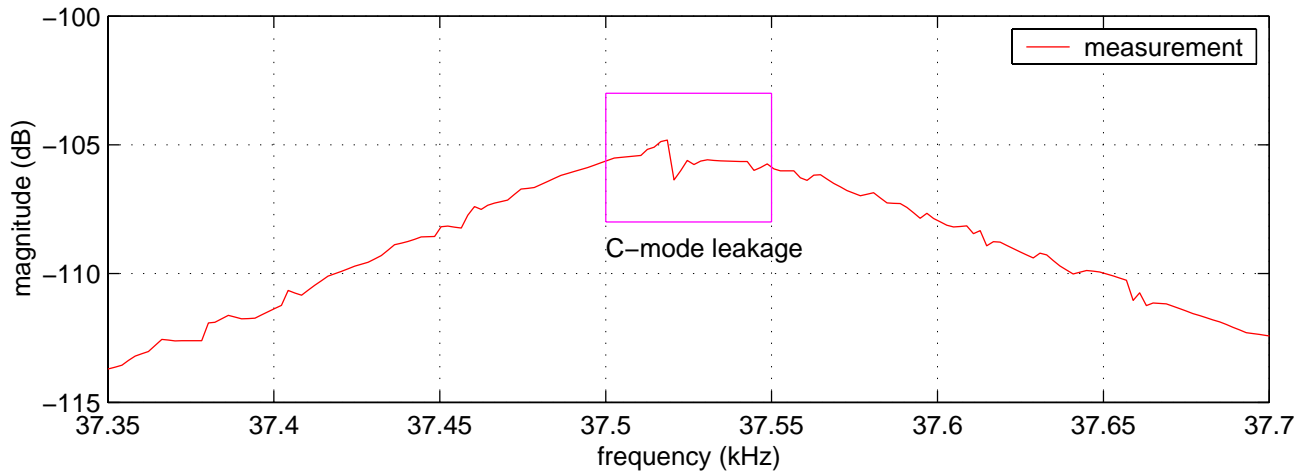

single arm excitation = sum of differential (D) and common (C) modes

dominant part: single cavity dynamics = D mode

small part: leakage of the C mode to the dark port

Conclusions

Phenomenology:

- verification of the time-domain equations for cavity field dynamics (carrier cusps at $\text{FSR} \times n$)
- test of our understanding of the signal extraction scheme (sideband dips in AS_Q and AS_I)
- observation of the field resonance caused by the cavity length variations at FSR
- study of new effects (resonance at 37.8 kHz)

Applications:

- measurement of the cavity length using the carrier cusps (does not depend on the laser frequency)
- measurement of the cavity length using sideband dips
- model validation (both for time and frequency domains)
- test of the PSL closed loop gain
- study of the effects of asymmetry