

*Advanced LIGO:*  
*Mechanical Systems, Systems Tests and  
Installation*



Dennis Coyne  
PAC-14 Review, 5 June 2003

- Seismic isolation
- Multiple pendulum suspensions
- Photon actuator
- System Tests
- Facilities
- Installation

## Seismic Isolation

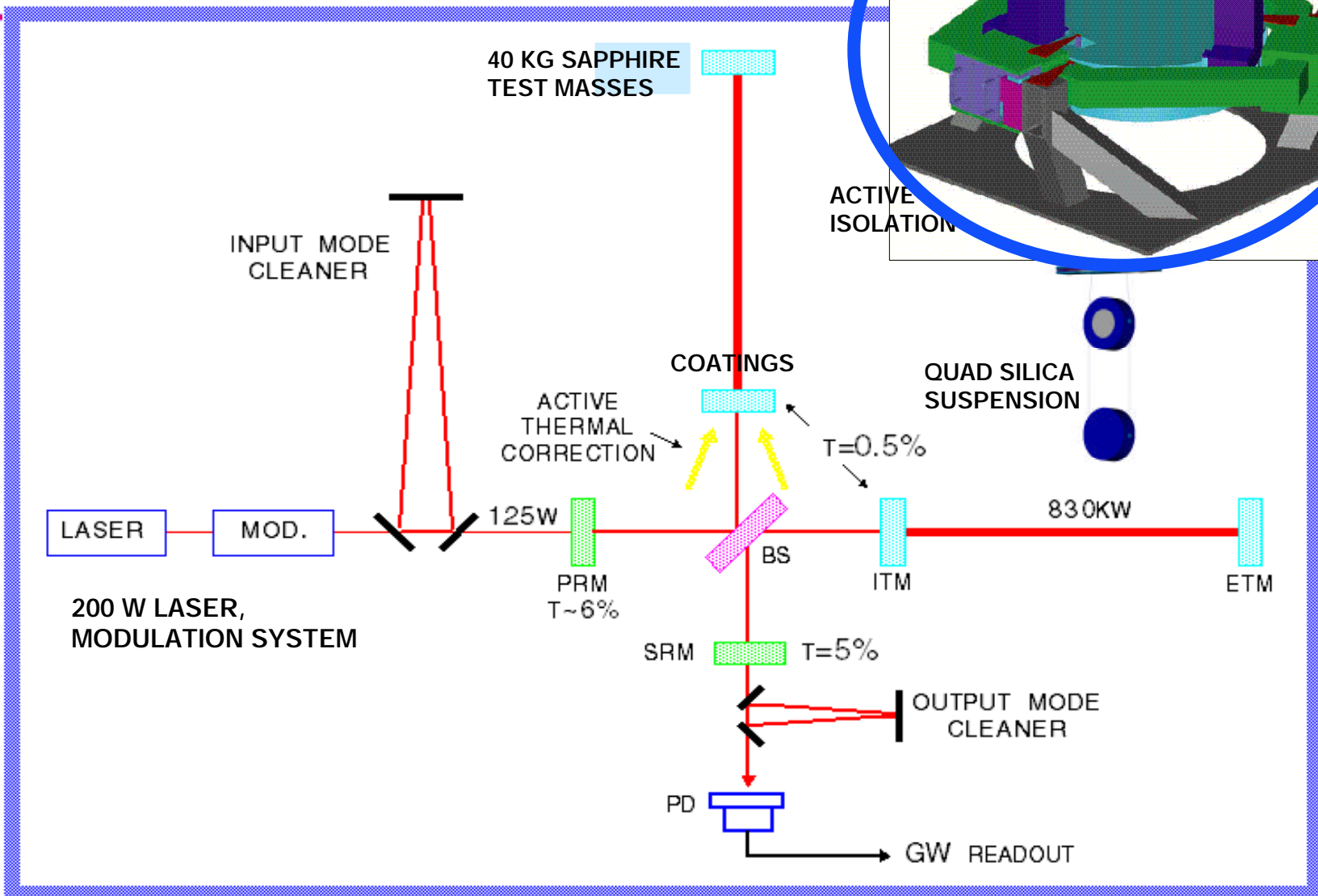
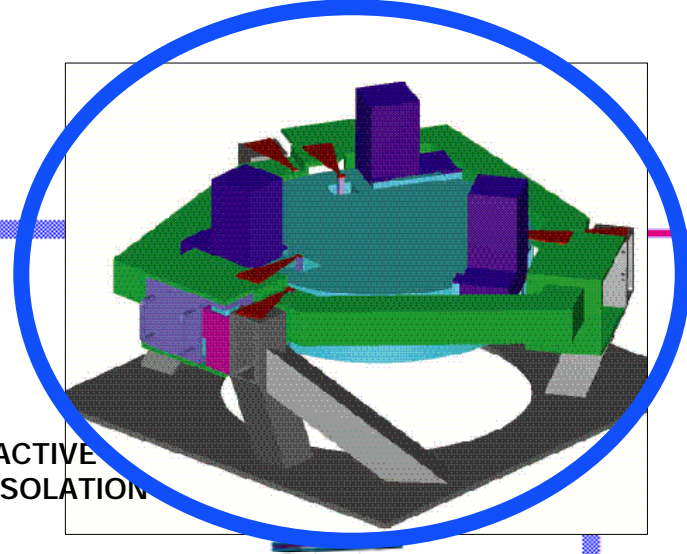

- Requirement: render seismic noise a negligible limitation to GW searches
  - » Newtonian background will dominate for >10 Hz
  - » Other 'irreducible' noise sources limit sensitivity to uninteresting level for frequencies less than ~20 Hz
  - » Suspension and isolation contribute to attenuation
- Requirement: reduce or eliminate actuation on test masses
  - » Actuation source of direct noise, also increases thermal noise
  - » Seismic isolation system can reduce RMS/velocity through inertial sensing, and feedback
  - » Acquisition challenge greatly reduced
  - » In-lock (detection mode) control system challenge is also reduced
  - » Choose to require RMS of  $<10^{-11}$  m

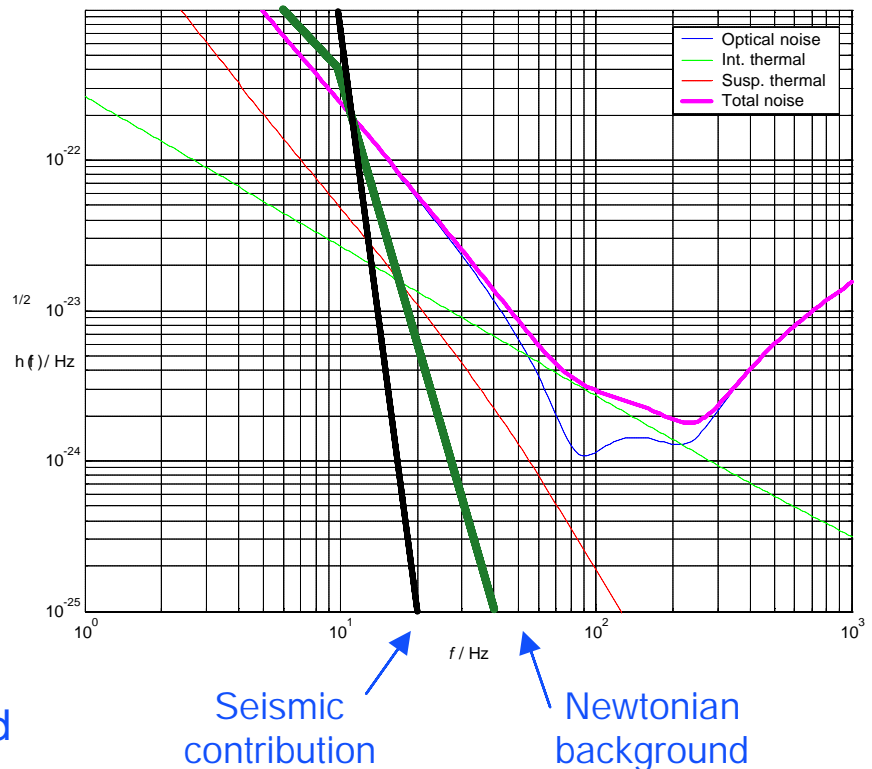

# *Isolation I: Pre-Isolator*

- External stage of low frequency pre-isolation
  - » tidal correction
  - » microseismic peak reduction
  - » DC Alignment/position control and offload from the suspensions and inner seismic isolation stages
  - » 1 mm pp range
- Prototypes in test and evaluation for early deployment at LLO in order to reduce the cultural noise impact on initial LIGO

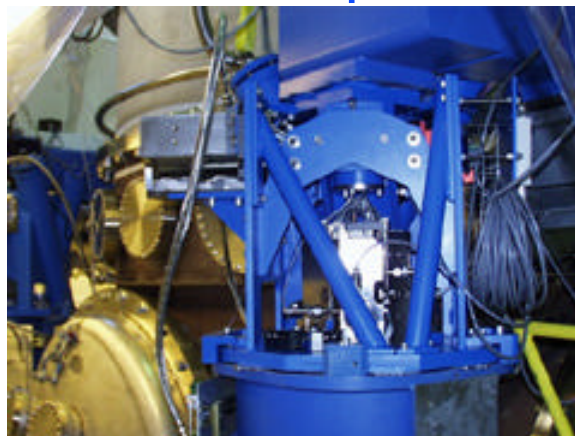

# Isolation II: Two-stage platform

- Choose an active approach:
  - » high-gain servo systems, two stages of 6 degree-of-freedom each
  - » Allows extensive tuning of system after installation, different modes of operation, flexible placement of main and auxiliary optics on inertially quiet tables
  - » Dynamics decoupled from suspension systems
- Stanford Engineering Test Facility Prototype coming on line
  - » Mechanical system complete
  - » Instrumentation being installed for modal characterization
- The original 2-stage platform continues to serve as testbed in interim
  - » Recent demonstration of sensor correction and feedback over broad low-frequency band

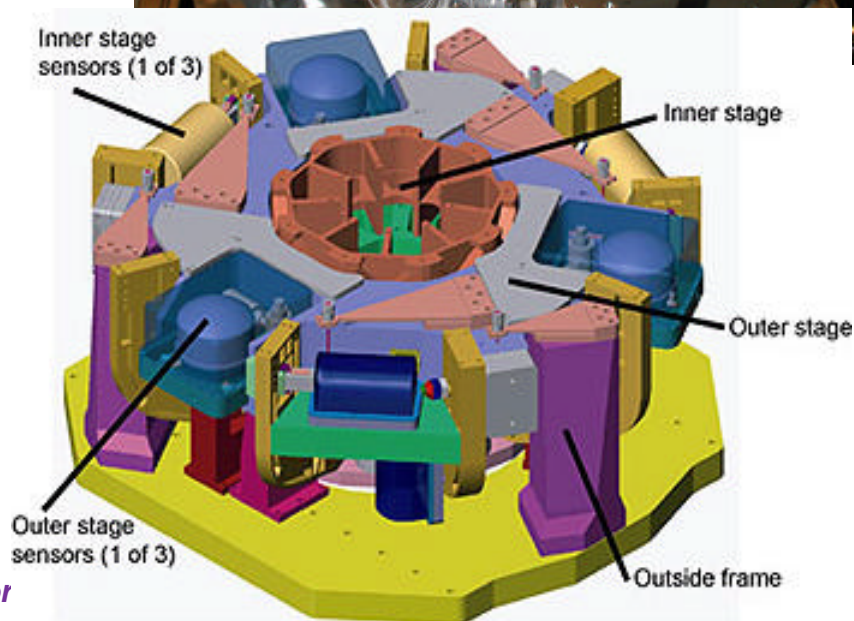

## Suspension

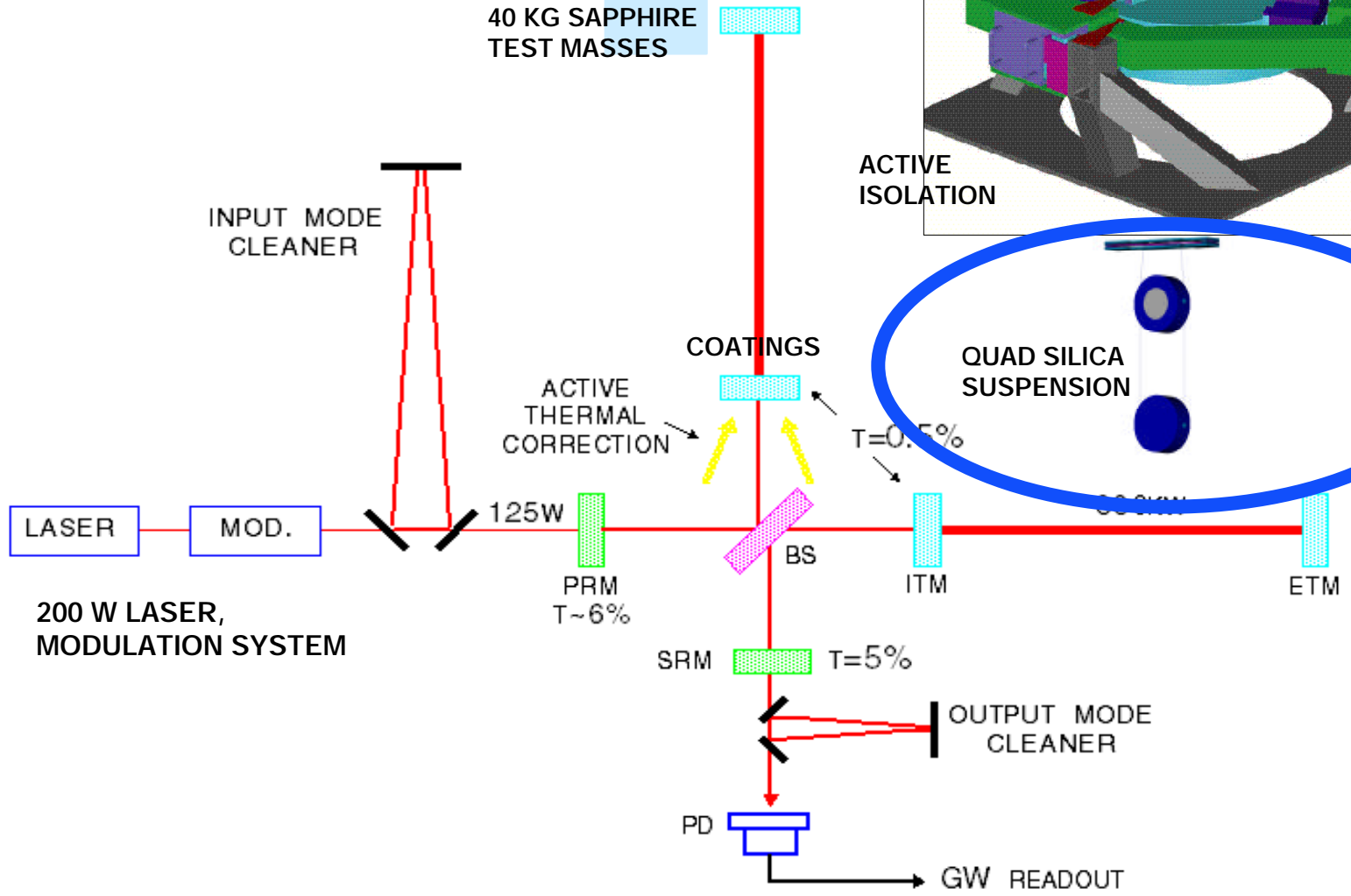
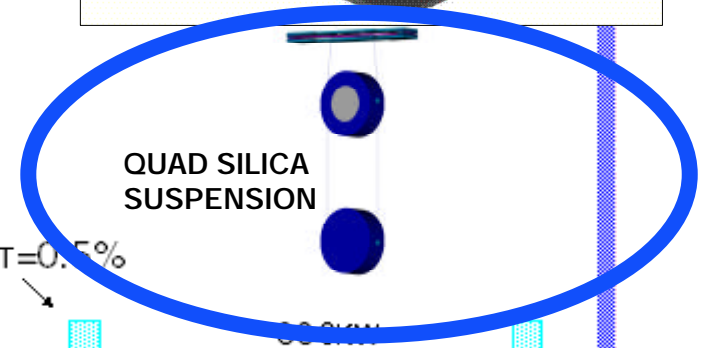
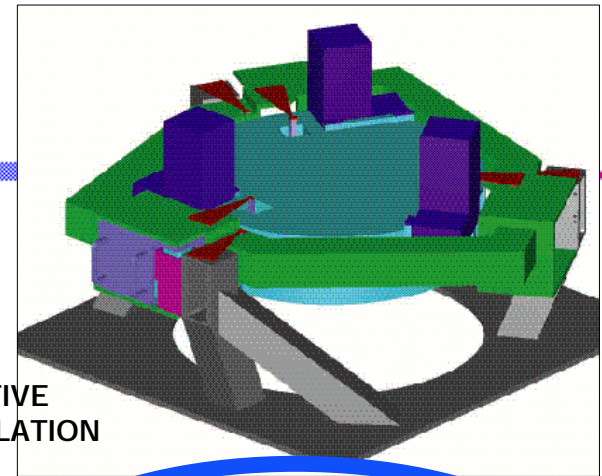

- Suspension Functions:
  - » Suspension mechanics for all core optics, mode cleaner optics (input and output) and mode matching telescope elements (input and output), up to the attachment points on the optic
  - » Procurement and bonding of attachments to core optics for suspension points
  - » Local sensing and damping of all suspension rigid body modes
  - » Additional seismic isolation
  - » Actuation capability for global control
- Primary performance requirements:
  - » suspension rigid body eigenfrequencies < 10 Hz (possibly < 12 Hz; under review)
  - » Lowest fiber/ribbon violin mode frequency > 400 Hz
  - » Displacement noise at 10 Hz:
    - Each seismic platform <  $2 \times 10^{-13}$  m/rtHz
    - Test Masses (TM) Quadruple Suspension <  $1 \times 10^{-19}$  m/Hz at 10 Hz including vertical-horizontal coupling of 0.1% (local damping inactive)
    - Beam Splitter (BS) Quadruple Suspension <  $2 \times 10^{-17}$  m/Hz including vertical-horizontal coupling of 1.4%
    - Power & Signal Recycling Mirrors (PRM, SRM) <  $3 \times 10^{-16}$  m/Hz including vertical-horizontal coupling of 0.6%



- Design based on GEO600 system:
  - » silica suspension fibers for low thermal noise
  - » multiple pendulum stages for seismic isolation
- PPARC Funding Approved
  - » significant financial and technical contribution
  - » quad suspensions, electronics, and some sapphire substrates
  - » U Glasgow, U Birmingham, Rutherford Appleton Lab
  - » Builds on success of GEO600 triple pendulums
- Prototyping Plan:
  - » Controls Prototypes: dynamics characterization, damping control, acquisition actuation development, assembly & installation tooling & procedure check out
  - » Noise Prototypes: full scale performance tests to support final design, materials/bonds thermal noise limits set, electronics loop noise tested
  - » Mode cleaner triple suspension prototype now being built for LASTI Full Scale Test; Quad SUS design is underway
  - » Both fused silica ribbon and dumbbell fiber prototypes are now being made and tested
- Challenge: developing means to damp solid body modes quietly

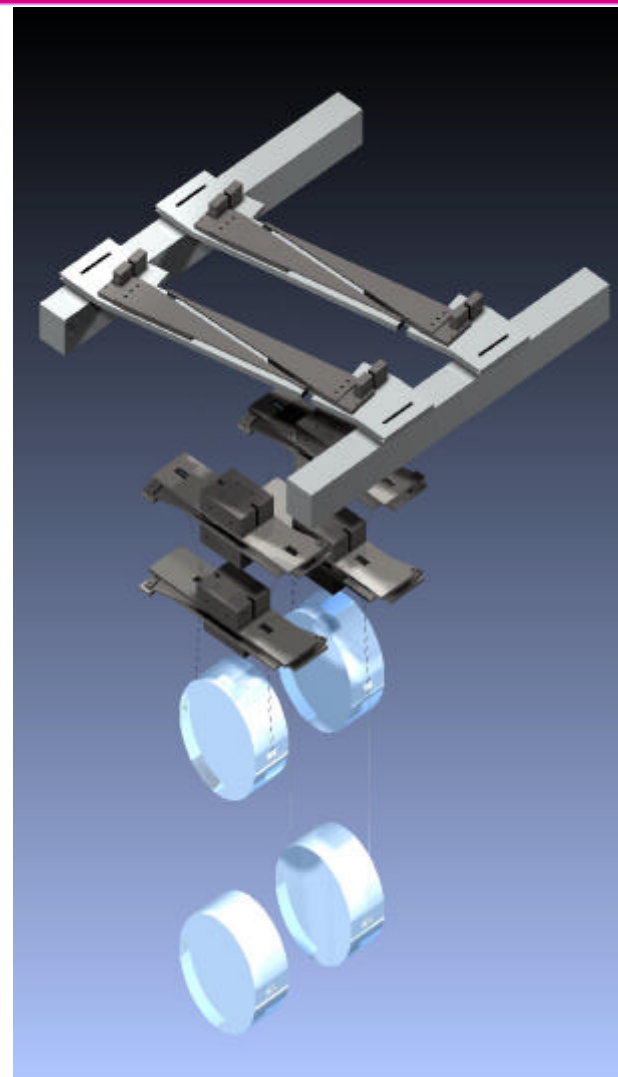

# Recent Progress: Suspension Prototyping

Mode cleaner triple pendulum:  
(3.5kg 'silica' mirror, all magnetic actuation,  
no reaction mass chain)

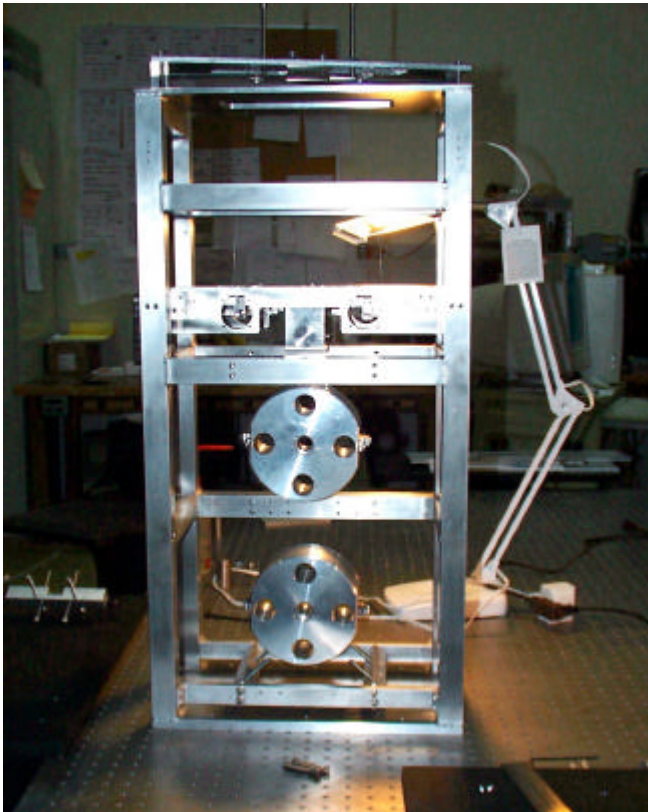

LIGO-G030270-00-D

to be installed  
in LASTI



quadruple pendulum dynamics simulator  
(30kg 'sapphire' mirror, reaction mass  
chain for quiet actuation)

- Deviations from ideal blade compliance complicate suspension design in many ways:
  - » Total deflection of ~10cm must be precise to ~1mm to match interface tolerances of actuators, beam centering, etc.
  - » Some suspension modes are sensitive to precise distance from blade tips to center of gravity of mass
- Several solutions now in use
  - » Build a large inventory of blades, select best samples
  - » Trim total blade deflection by trimming masses below
  - » Trim blade tip position with angled clamps
  - » Exploring EDM machining as well as precision roll forming



un-stressed blade



stressed blade

- Silica ribbons made in Glasgow have up to 2.9GPa tensile strength, far above 760MPa working stress.
- Fibers can have both low thermal noise and low bounce frequency with a suitable diameter profile (the ‘dumbbell’ fiber), giving us another option to meet suspension thermal noise specs. Strengths are also high.

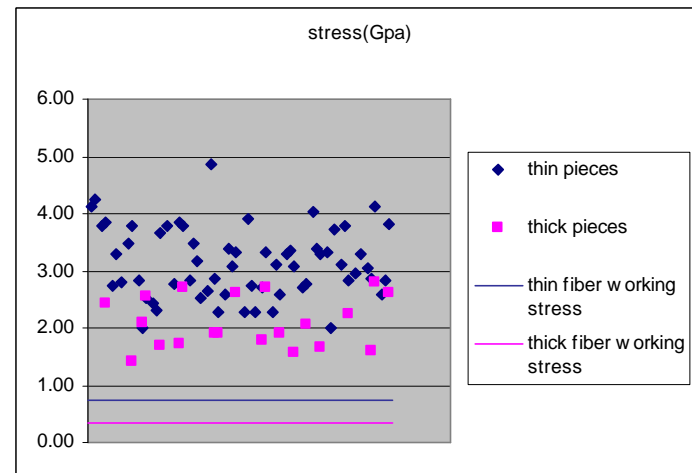

measured dumbbell fiber strengths

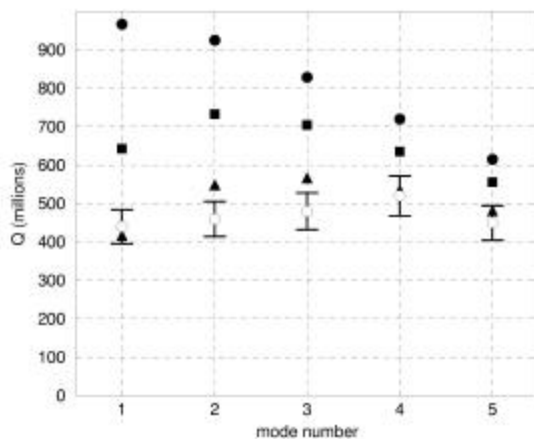

- Fiber Q's over  $4 \times 10^8$  have now been measured.

## *Local Damping*

- Eddy current damping under development
  - » as tested OK for triple SUS, but not as strong as desired for heavier quadruple pendulum suspensions
- Shadow sensors are too noisy ( $10^{-10}\text{m}/\sqrt{\text{Hz}}$ , need less than  $10^{-13}\text{m}/\sqrt{\text{Hz}}$ ) for the quadruple suspensions

### Solutions being considered:

- » Stronger eddy current dampers -- under consideration at Glasgow
- » Quieter interferometric position sensors- being tested at Caltech
- » 6 degree-of-freedom, tuned mass, eddy current damper being considered by MIT Mechanical Engineering group
- » Two-stage damping: large range & noisy for acquisition, then short range & quiet for operation
- » Relaxed damping specifications

prototype interferometric sensor

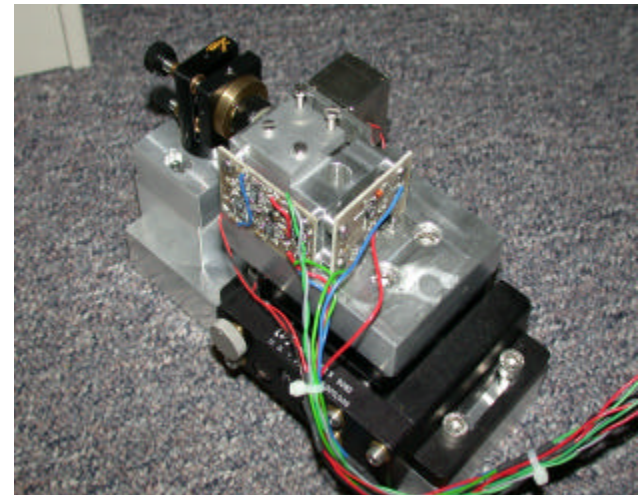

## Creep and Excess Noise

- Noise of nonthermal origin is known to exist, but is poorly quantified
- Measurements of fiber excess noise at Syracuse and Moscow are ongoing
- Other sources (e.g. from the mirror or coating or bonded ear attachment) still unknown, though the TNI, GEO600, and LIGO itself can eventually quantify these.

Fiber creep measurement at Perugia

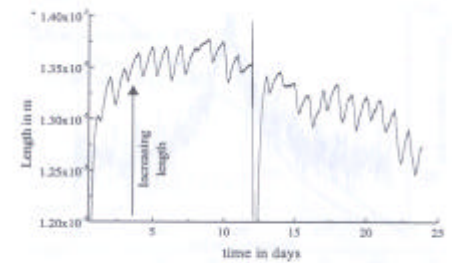

FIGURE 8. Creep of a 60 cm long 200  $\mu\text{m}$  diameter fused silica wire loaded with 5.5 kg.

Silicate bond thermal creep measured at Caltech

22°C

90°C

120°C

90°C

22°C

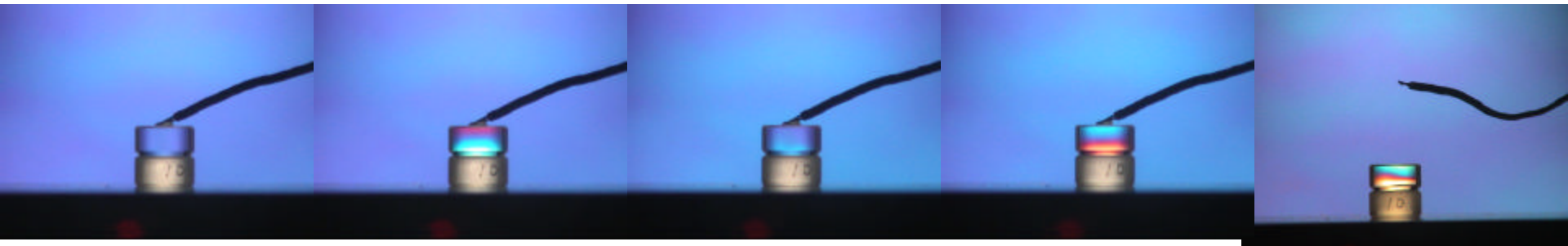

# *GEO600 as Advanced LIGO Prototype*

- Advanced LIGO suspension is based upon the GEO600 design
  - » GEO600 itself will provide a wealth of data and experience in the use of such suspensions
  - » Results to date have been very promising, with the suspensions being robust and controllable with a very high (>97%) locked duty cycle.
- Suspension Triple Lab Tour is available

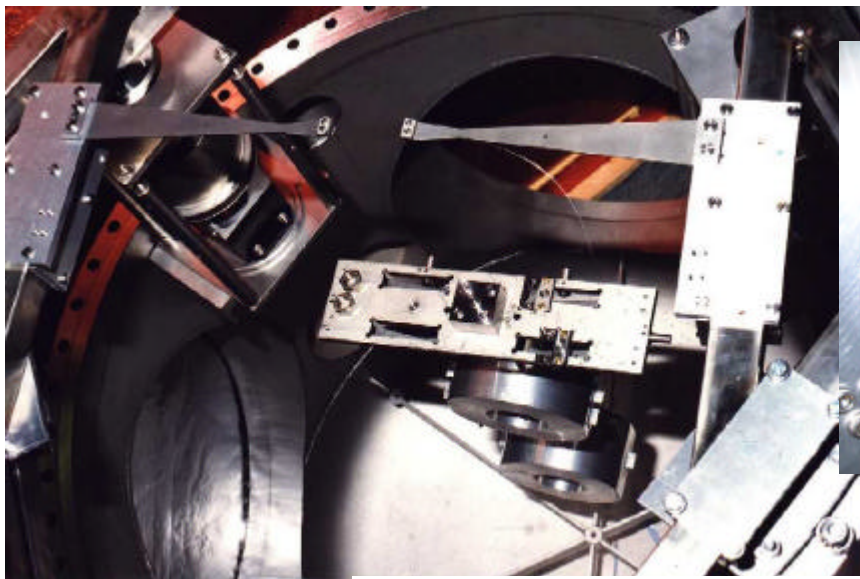

LIGO-G030270-00-1 **GEO Suspension Prototype**



**Hybrid LIGO/GEO Local Damping Sensors**



**LIGO Triple Prototype**

# Control Hierarchy

- Electromagnetic forcers
  - » Damping control actuators
  - » Reaction chain actuator for longitudinal control of intermediate masses
  - » UK Team scope
- Electrostatic forcer
  - » High bandwidth, “high” force, test mass actuator for lock acquisition
  - » UK Team scope
- Photon actuator
  - » High bandwidth, low force, low noise, test mass actuator to stabilize optical modes in detection (locked cavity) mode
  - » US Team scope

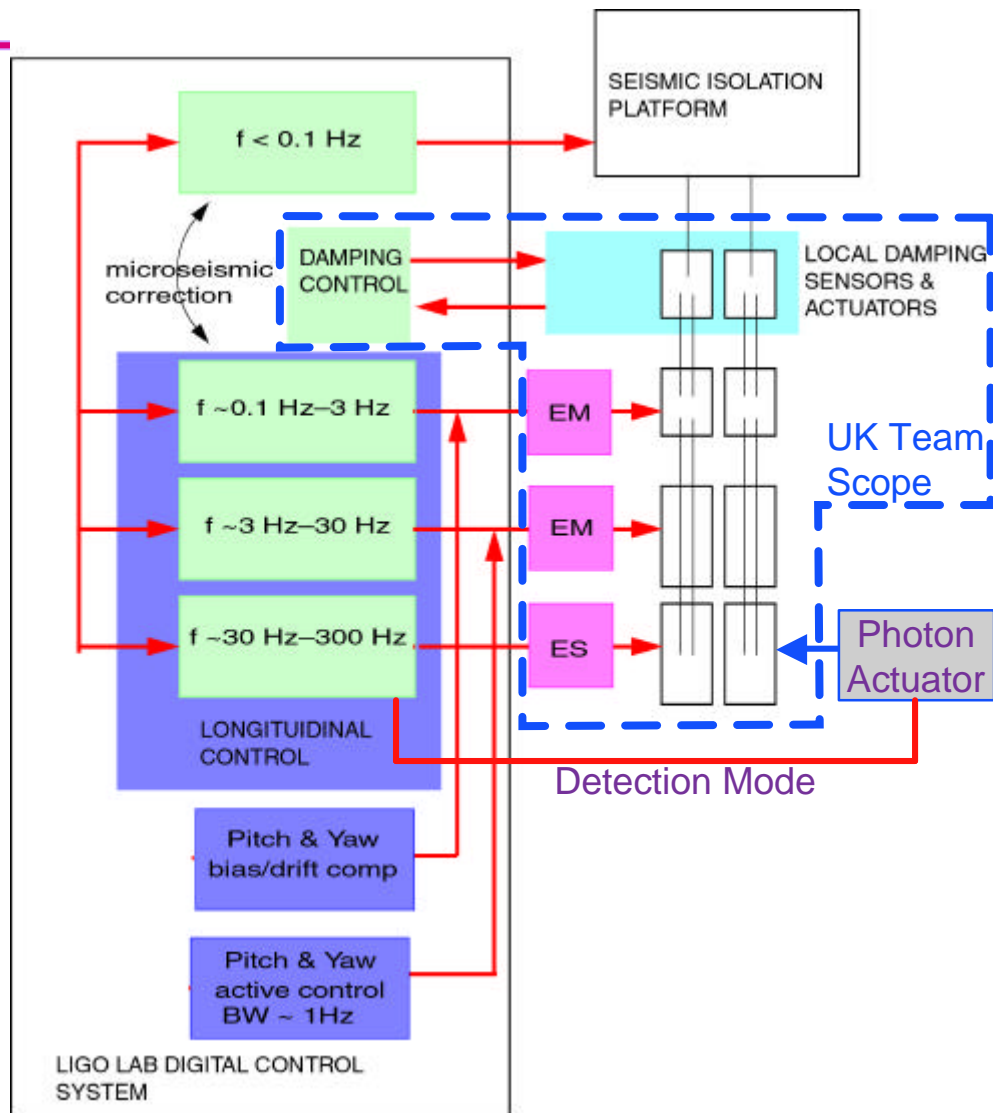



Stage	Pitch & Yaw bias	Longitudinal Lock	Actuator Noise N/ÖHz	Dynamic Range ÖHz	Maximum Force
Upper control mass	50 mN	1 mN	$2 \times 10^{-11}$	$5 \times 10^7$	40 mN
Penultimate mass	?	0.1 mN	$5 \times 10^{-13}$	$2 \times 10^8$	1 mN
Test mass		0.1 nN	$2.5 \times 10^{-15}$	$4 \times 10^4$	1 nN

# *Photon Actuator Conceptual Design*

- Laser source
  - » ~1 W
  - » Wideband active stabilization to suppress amplitude noise, by a factor of  $10^4$  to  $10^6$  depending on the initial laser noise level.
  - » Current-shunt actuator developed by LIGO
- » Optical arrangement
  - » Single bounce off end test mass, high reflectance surface
- » Breadboard/concept test
  - » Planned for this summer in the 40m lab using initial LIGO photon calibrator system
  - » Low risk development

# *System Test Philosophy*

- More subsystem and system level testing is planned for advanced LIGO than for initial LIGO
  - » Avoid taking down the working observatories to solve design or workmanship problems
  - » All subsystems must perform prototype & final article testing to assure fit, function and performance (to a practical extent)
- Integrated System Testing:
  - » 10m Lab & 40m Lab
    - Integrated optical plant and controls testbeds
  - » LASTI:
    - Full scale mechanical testing (Seismic isolation + suspensions)
    - Integrated Mode Cleaner and PSL test
  - » Gin Gin Facility:
    - High power optical cavity testing including thermal compensation
    - Component/technology testing at LLO by UFL & LIGO Lab

- Qualify advanced isolation & suspension systems and associated controls at full mechanical scale
- Develop detailed SEI/SUS installation & commissioning handbook
- Look for unforeseen interactions & excess displacement noise
- Test LASER and Input Mode Cleaner together at full power

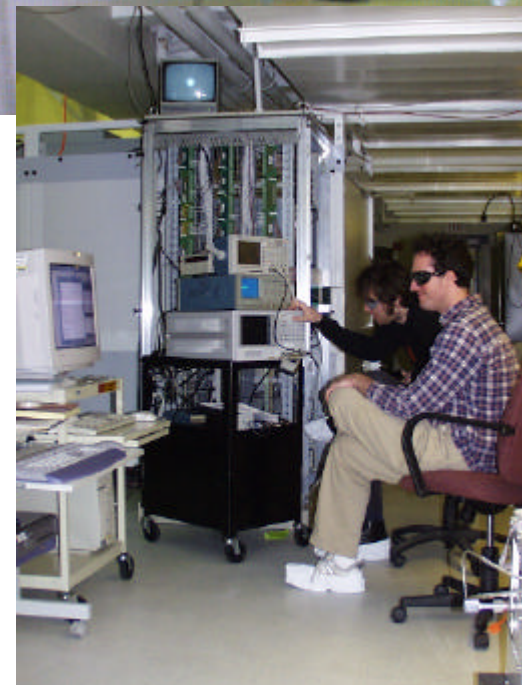
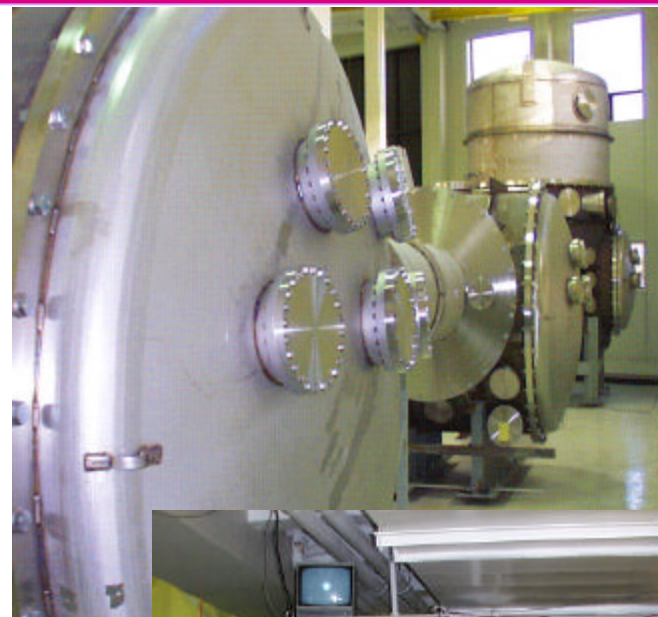

✓ done

- ✓ Commission infrastructure (vacuum, cleanrooms, cranes...) ☰
- ✓ Commission PSL & controls ☰
- ✓ Commission initial seismic stack, suspensions & 1m test cavity in HAM chamber ☰

➤ In-process

- Develop & test EPI for LLO seismic remediation
- Qualification test of early pre-prototype triple pendulum

• TBD

- Integrate/test active HAM SEI pathfinder
- Integrate/test active BSC SEI pathfinder
- Integrate/test Quad and Triple suspensions
- Integrate/test sapphire & fused silica core optics
- Qualify for low displacement noise with sensitive interferometer system
- Integrate/test AdLIGO 180 Watt PSL & Mode Cleaner

*In each step, develop installation & test procedures to optimize AdLIGO upgrade*

# Gin Gin Facility Configuration

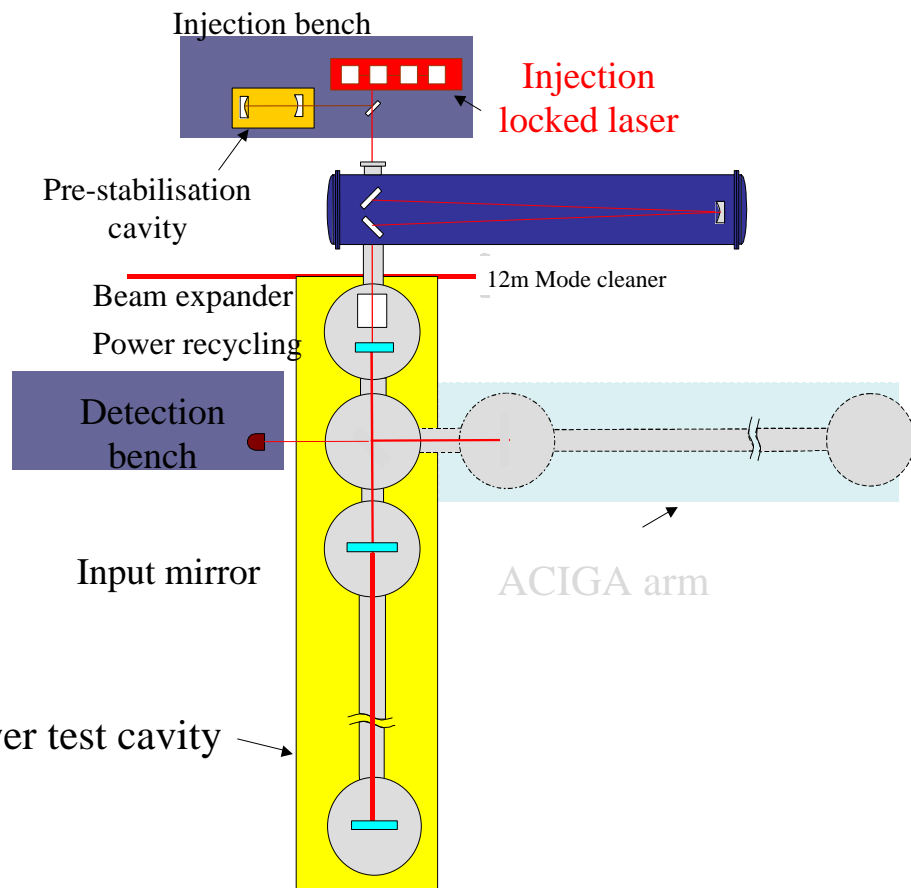

# LIGO High Power System Tests at the ACIGA Gin Gin Facility

- Primary Objectives:

- » Scaled test of active thermal compensation system
- » Investigate phenomena due to very high optical power in a cavity with suspended optics
- » LIGO has prepared two initial LIGO small optics suspensions and controllers for shipment to Gin Gin

## Test 1



## Test 2



## Test 3



- Signal Recycling (SR) Experiment (without Power Recycling)
  - » Rapid initial exploration of optical plant and sensing matrix as input to 40m technical program planning
  - » 100 MHz / 12 MHz modulation with 12, 100, 88 MHz demodulation works and is practical
  - » All sensing matrix elements have predicted values
  - » Transfer of the VHF photodetector technology used in the SR experiment (plus other R&D directed in support of the 40m program)
  - » Final SR results expected late 2003
- Glasgow science team visits in support of the 40m effort



- Primary objective: full engineering prototype of optics control scheme for a dual recycling suspended mass interferometer, as close as possible to the Advanced LIGO optical configuration and control system
- a seventh mirror for signal recycling
  - » length control goes from 4x4 to 5x5 MIMO
- detuned signal cavity (carrier off resonance)
- pair of phase-modulated RF sidebands
  - » frequencies made as low and as high as is practically possible
  - » unbalanced: only one sideband in a pair is used
  - » double demodulation to produce error signals
- short output mode cleaner
  - » filter out all RF sidebands and higher-order transverse modes
- offset-locked arms
  - » controlled amount of arm-filtered carrier light exits asym. port of BS
- DC readout of the gravitational wave signal



# Differences between AdvLIGO and 40m prototype

- **Initial LIGO single pendulum suspensions will be used**
  - » No room for full scale AdvLIGO multiple pendulums – to be tested at LASTI
  - » Scaled-down versions to test controls hierarchy later in the program?
- **Only commercial active seismic isolation**
  - » STACIS isolators on all test chambers, ~30 dB of isolation from 1-100 Hz
  - » No room for anything like full AdvLIGO design – to be tested at LASTI
- **Initial LIGO 10-watt laser, negligible thermal effects**
  - » Other facilities will test high-power laser (LASTI, Gingin)
  - » Thermal compensation tested at Gingin
- **Small (5 mm) beam spot at Test Masses; stable arm cavities**
  - » AdvLIGO will have 6 cm beam spots, using less stable cavities
  - » 40m can move to less stable arm cavities if deemed useful
- **Arm cavity finesse at 40m chosen to be = to AdvLIGO**
  - » Storage time is x100 shorter
  - » significant differences in lock acquisition dynamics, in predictable ways
- **Control RF sidebands are 33/166 MHz instead of 9/180 MHz**
  - » Due to shorter PRC length
  - » Less contrast between PRC and SRC signals

- Characterized the initial LIGO mode cleaner performance, and its interaction with the pre-stabilized laser system
  - Installed 8 of 10 initial-LIGO-like suspension/optics assemblies and associated digital suspension controllers, for the main dual recycled interferometer.
  - Several key auxiliary systems, the balance of the suspension systems, initial LIGO-like Length Sensing & Control (ISC) and Alignment Sensing & Control (ASC) systems will be installed before the end of 2003
  - First experiments in dual recycled configuration response, lock acquisition, and control are expected to take at least a year
- 40m Lab Tour is available



# *Observatory Facility Modifications for Advanced LIGO*

- Existing staging buildings at both observatories
  - » Will require additions of flow benches, fume hoods, vacuum bake ovens, softwall cleanrooms and other minor equipment to support clean processing operations. In addition, at LHO some retrofit of the HVAC system will be necessary in the Staging Building to meet the cleanliness requirements
- Converting the Hanford 2 km interferometer to 4 km
  - » remove and reinstall the existing mid-station chambers and replace them with spool pieces
- The larger mode cleaner suspensions in the input optics section (and possibly the output optics section)
  - » Will change out the input optics vacuum tube for a larger diameter input section (and possibly output section) vacuum tube

# Larger Diameter Mode (MC) Cleaner Tubes

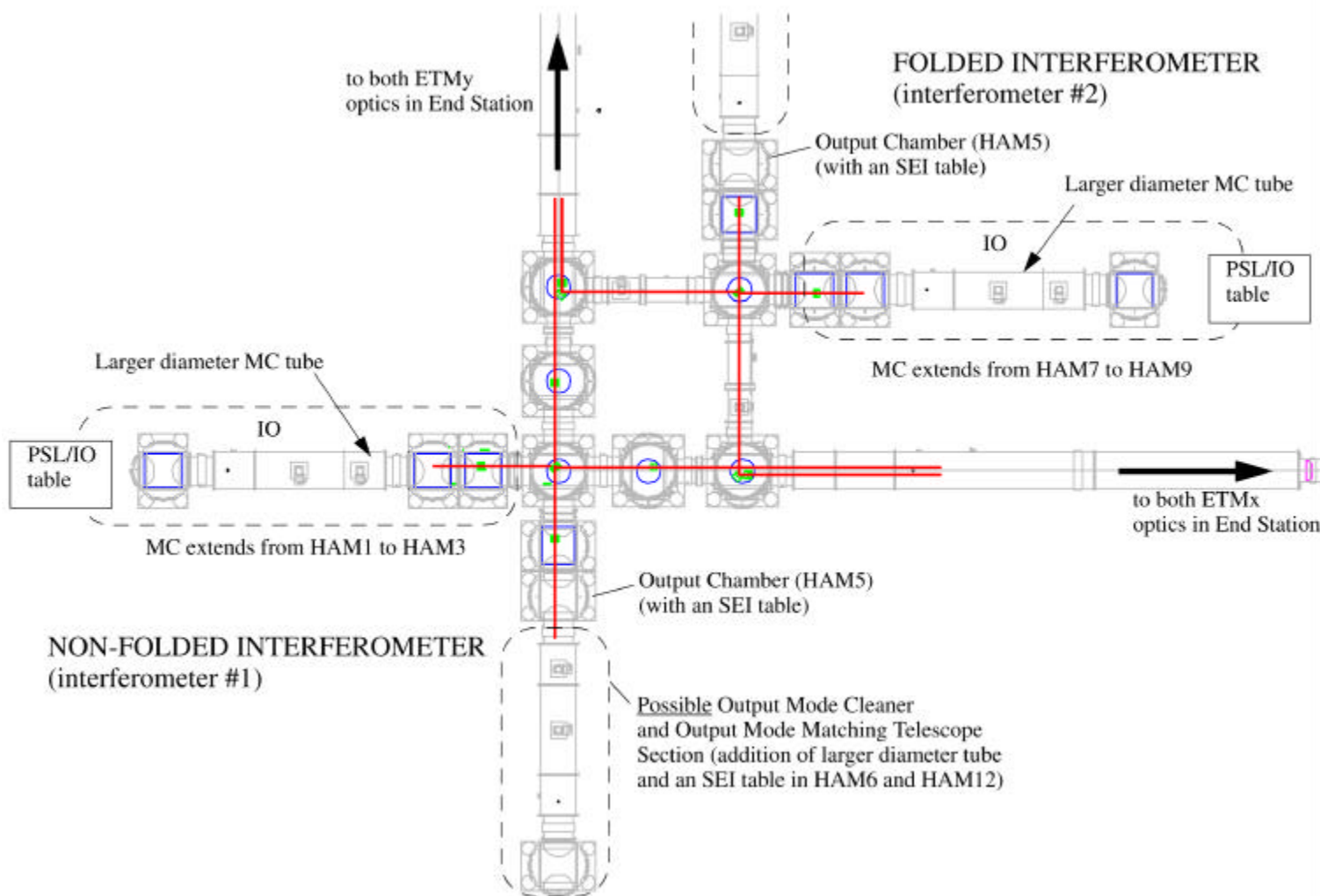

- The installation & commissioning directed by the LIGO Lab
  - » LSC technology developers in the LSC will participate in installation and commissioning of their respective components
  - » Most of the labor required will come from the Laboratory staff or contractors.
- Installation practice for the major mechanical subsystems at the MIT LASTI testbed by subsystem and observatory staff
- Pre-assembly, pre-alignment and pre-testing (to the extent possible), e.g.
  - » Seismic systems will be fully preassembled and sealed for transport from onsite staging buildings into the vacuum equipment areas
  - » Suspensions will be preassembled onsite up to attachment of the final silica fibers and test masses
- Two shifts of installation are planned only for labor-intensive activities on the critical path and held in reserve for contingency for non-critical tasks

- Baseline plan:
  - » Global observing network status, agreements between projects, & scientific developments may alter the order of, or interval between, upgraded interferometers
  - » Plan is to perform the physical installation as rapidly as possible to maximize the time for debugging, characterization and commissioning
- In late 2006, the three initial LIGO interferometers will complete their coincident observation run
  - » Livingston instrument will be switched off & adv. LIGO installation will start.
  - » the subsystem components will have been pre-positioned at the sites, assembled and tested
- Mid 2007, LIGO Hanford advanced LIGO installation will start
  - » The seismic isolation installation will be completed at Livingston by that time, and that installation team will migrate to Hanford
  - » This staggered pattern will continue with the suspensions, optics, and the other subsystems.
- Interferometers will be commissioned & ready for Engineering Runs by 2010