

# Advanced LIGO Research and Development

David Shoemaker  
NSF Annual Review of LIGO  
8 November 2004

- LIGO established to house a progression of instruments of increasing capability
    - » Nominal 30-year lifetime for infrastructure; this is probably conservative
  - Initial LIGO plan is for one integrated year of observation at the design sensitivity
    - » Plan to start this interval in 2005
  - Next instrument should be significantly more sensitive, and enable astronomy using gravitational wave signals
- ➔ Advanced LIGO is the LIGO Lab, and LSC, proposal for the next generation instrument to be installed in at the Observatories

## Initial and Advanced LIGO

- Factor 10 better amplitude sensitivity
  - »  $(\text{Reach})^3 = \text{rate}$
- Factor 4 lower frequency bound
- NS Binaries: for three interferometers,
  - » Initial LIGO:  $\sim 20$  Mpc
  - » Adv LIGO:  $\sim 350$  Mpc
- BH Binaries:
  - » Initial LIGO:  $10 M_{\odot}$ , 100 Mpc
  - » Adv LIGO :  $50 M_{\odot}$ ,  $z=2$
- Stochastic background:
  - » Initial LIGO:  $\sim 3e-6$
  - » Adv LIGO  $\sim 3e-9$

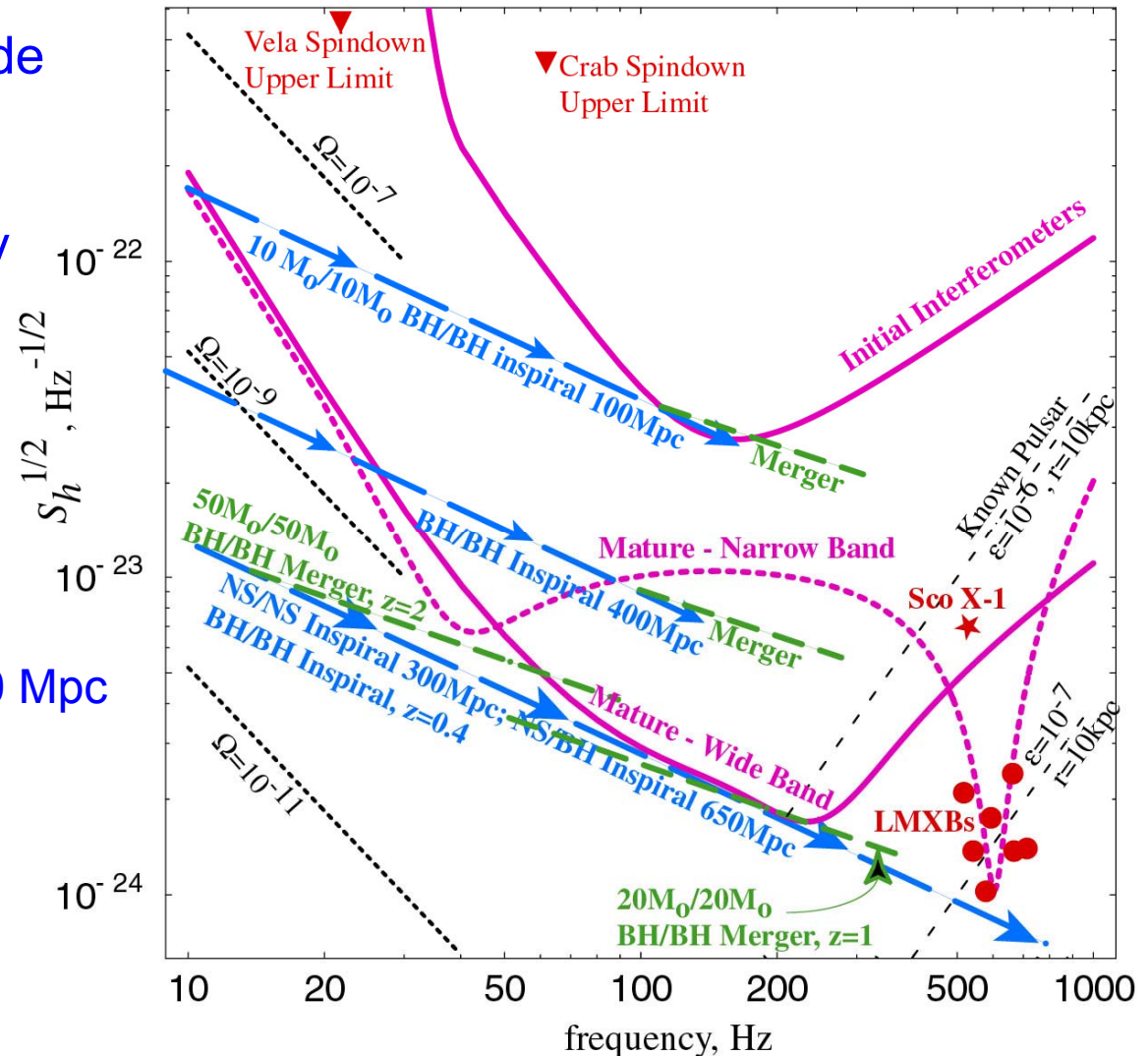

# Anatomy of the projected Adv LIGO detector performance

- Newtonian background, estimate for LIGO sites
- Seismic 'cutoff' at 10 Hz
- Suspension thermal noise
- Test mass thermal noise
- Unified quantum noise dominates at most frequencies for full power, broadband tuning
- Advanced LIGO's Fabry-Perot Michelson Interferometer is flexible – can tailor to what we learn before and after we bring it on line, to the limits of this topology

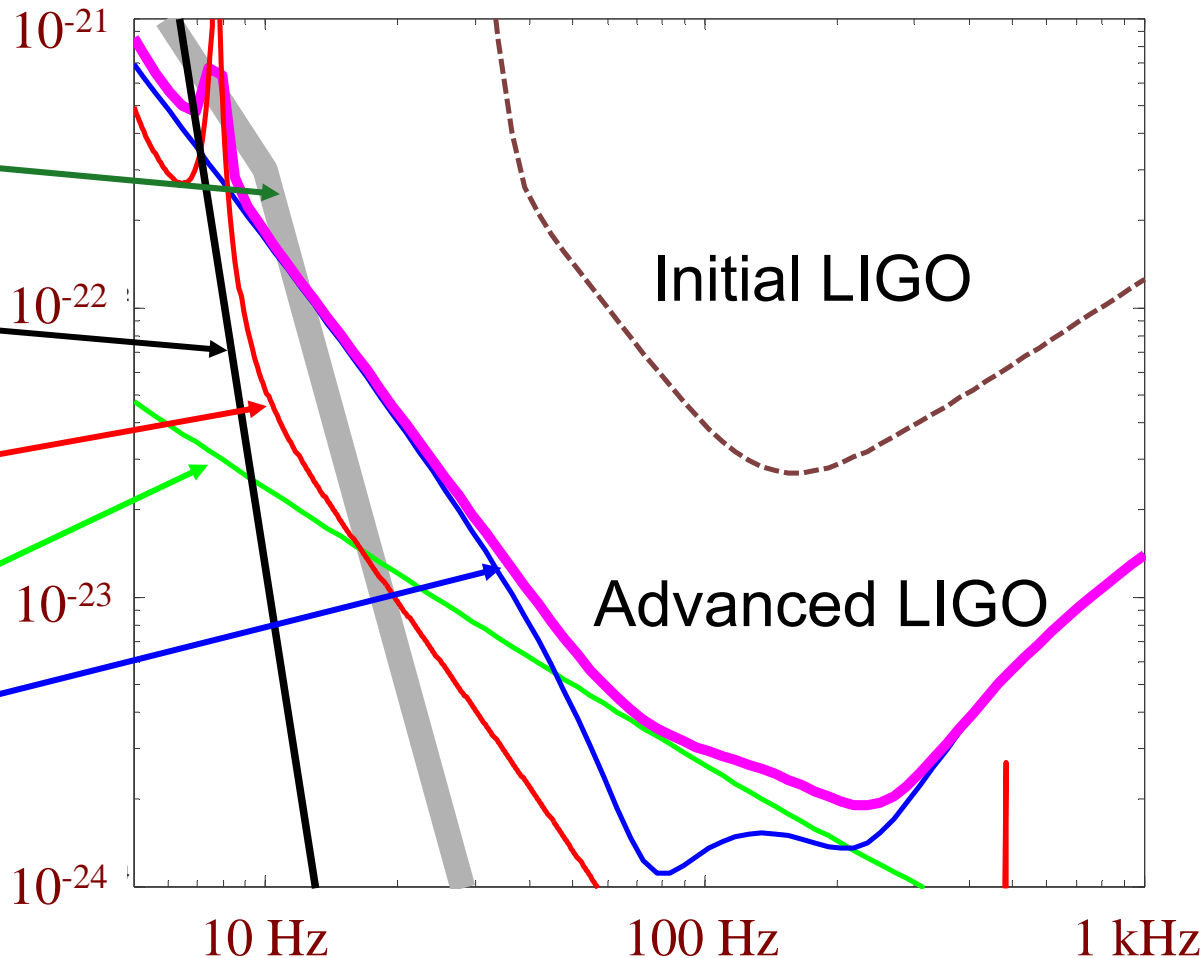

# Limits to the performance

- Two basic challenges:
  - » Sensing the motion of the test masses with the required precision; ideally limited by quantum effects
  - » Reducing undesired motion of the test masses which can mask the gravitational wave; intrinsic thermal motion a fundamental limit, seismic noise an obvious difficulty
- Many 'merely technical' challenges
  - » Defects in the sensing system which give an excess above the quantum noise
  - » Control system sensors, dynamic range, actuators, etc.
  - » Work hard on these challenges to make system reliable, ease commissioning, improve statistics of noise, availability

# Sensing for **initial** LIGO

- Shot-noise limited – counting statistics of photons (or photodiode current)
  - » Precision improves with (laser power)<sup>1/2</sup> until....
- Transfer of momentum from photons to test masses starts to dominate
  - » 1/f<sup>2</sup> spectrum (inertia of test masses)
  - » Gives ‘standard quantum limit’
- Initial LIGO power recycled interferometer layout
  - » Michelson for sensing strain
  - » Fabry-Perot arms to increase interaction time
  - » Power recycling mirror to increase circulating power
  - ....still far from standard quantum limit

$$h(f) = \frac{1}{F^2 L} \sqrt{\frac{hc\lambda}{8P_{bs}}} \frac{1}{T_{ifo}(\tau_s, f)}$$

$$h(f) = \frac{2F}{ML} \sqrt{\frac{2\hbar P_{bs}}{\pi^3 c\lambda}} \frac{T_{ifo}(\tau_s, f)}{f^2}$$

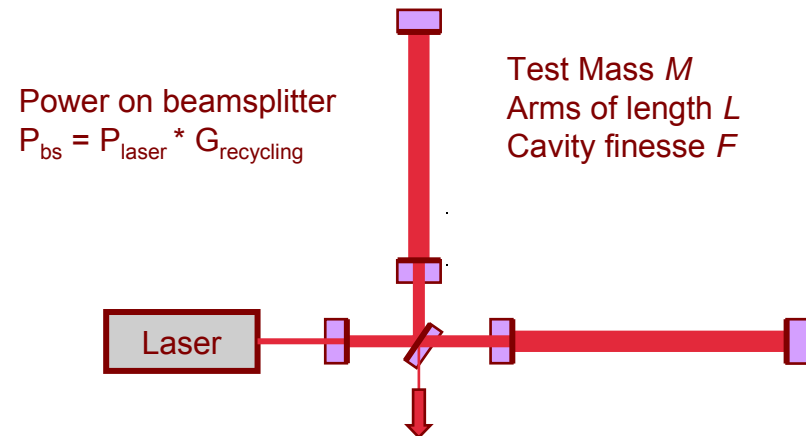

# Sensing for **Advanced** LIGO

- Build on initial LIGO layout –
  - » retain Fabry-Perot cavities, power recycling
- **Increase the laser power** to a practical limit to lower shot noise
  - » Laser power – require TEM00, stability in frequency and intensity
  - » Absorption in optics – state-of-the-art substrates and coatings, compensation system to correct for focussing
  - » ~180 W input power is the practical optimum for Advanced LIGO
  - » Leads to ~0.8 MW in cavities (6cm radius beams, though)
  - » Significant motion due to photon pressure – **quantum limited!**
- **Modify optical layout:** Add signal recycling mirror
  - » Gives resonance for signal frequencies – can be used to optimize response
  - » Couples photon shot noise and light phase through back reaction – some ‘accidental’ but useful squeezing of light

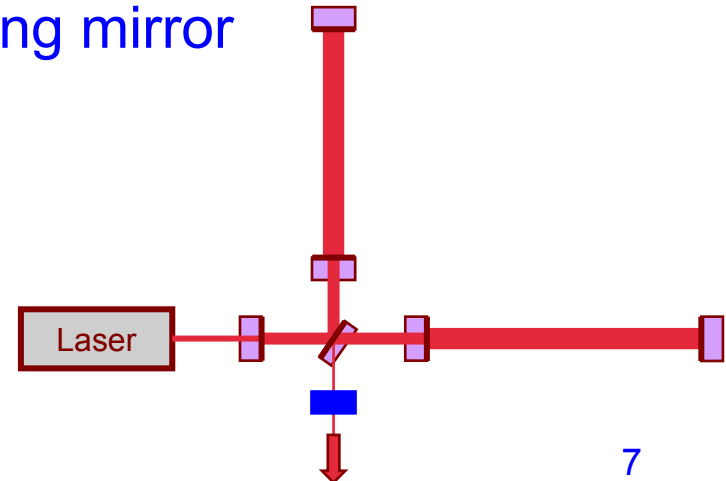

# Stray forces on test masses

- Most Important: **Make the interferometer long!**
  - » Scaling of thermal noise, seismic, technical goes as  $1/\text{length}$
  - » Cross-coupling from vertical to horizontal – 4km not far from ideal
- Thermal noise
  - »  $\frac{1}{2} kT$  of noise per mode
  - » Coupling to motion according to fluctuation-dissipation theorem
  - » **Gather the energy into a narrow band via low mechanical losses**, place resonances outside of measurement band by choosing the right geometry
- Initial LIGO: fused silica substrates, attachments made to limit increases in loss, steel suspension wire
- Seismic Noise
  - » Due to seismic activity, oceans, winds, and **people**
- Initial LIGO: cascaded lossy oscillators, analog of multipole low-pass filter – and now also an active pre-isolator



# Managing Stray forces in Advanced LIGO

- Seismic Isolation: use servo-control techniques and low-noise seismometers to 'slave' optics platform to inertial space
  - » Decreases motion in the gravitational-wave band to a negligible level
  - » Decreases motion in 'controls' band, moving forces away from test mass
- Suspension thermal noise: **all-silica fiber construction**
  - » Intrinsically low-loss material
  - » Welded and 'contacted' construction also very low loss
- Test mass thermal noise: use **very low mechanical loss materials**
  - » Sapphire or Fused Silica for substrate
  - » Low *mechanical* (as well as optical) loss optical coatings

## Design features

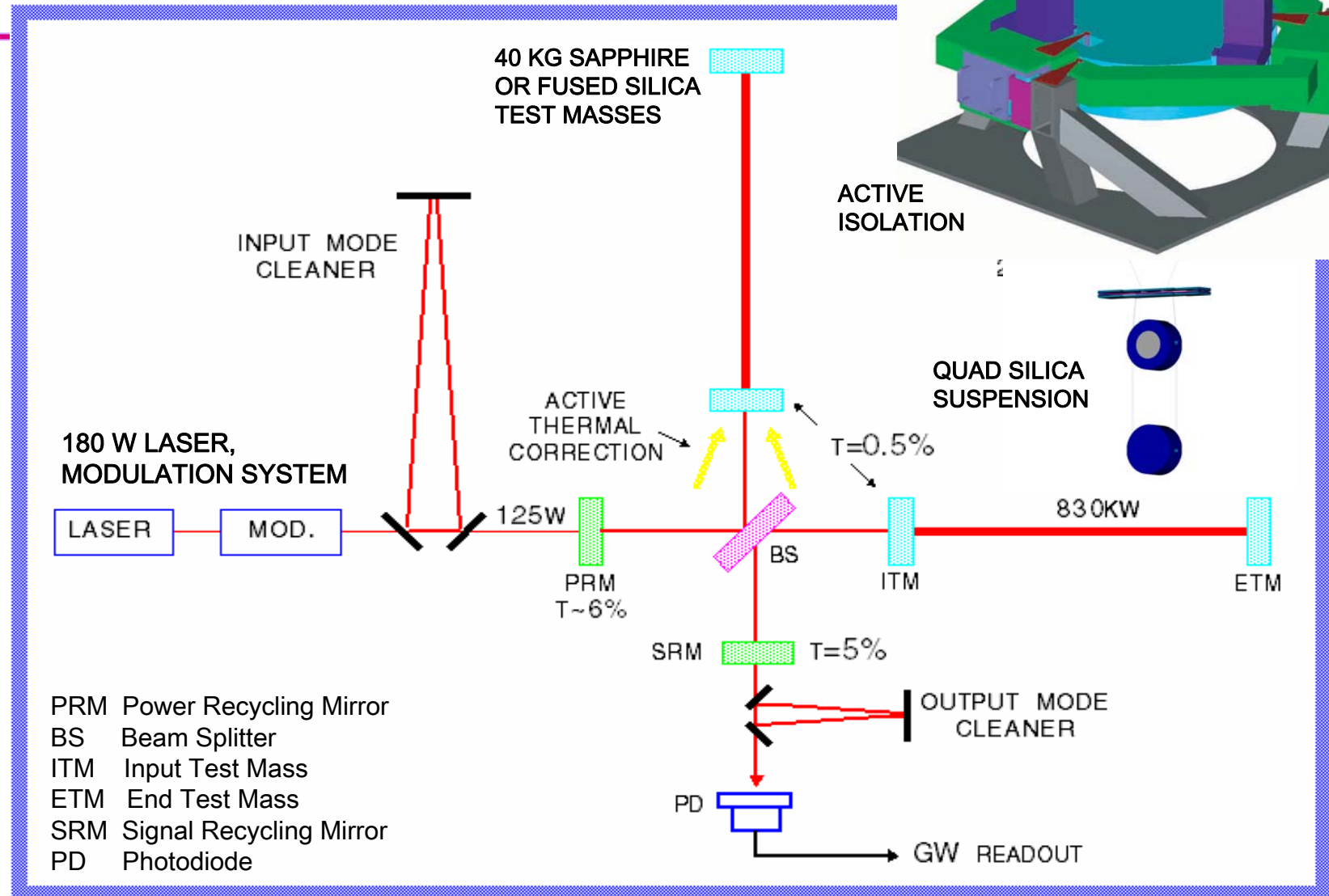

- PRM Power Recycling Mirror
- BS Beam Splitter
- ITM Input Test Mass
- ETM End Test Mass
- SRM Signal Recycling Mirror
- PD Photodiode

## Laser

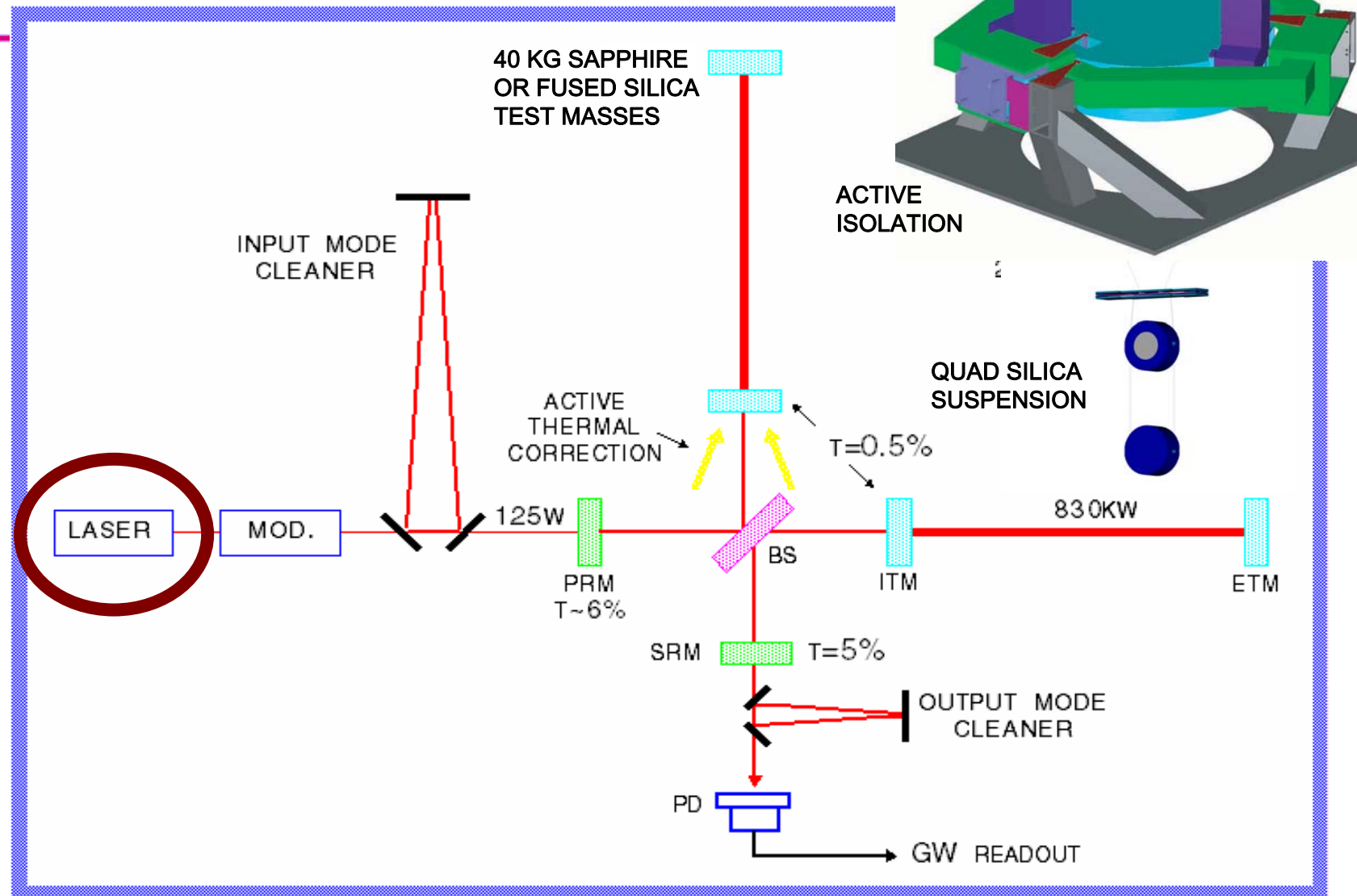

# Pre-stabilized Laser

- Require the maximum power compatible with optical materials
  - » **Requirements:** 180 W at output of laser, leads to 830 kW in cavities
  - » Continue with Nd:YAG, 1064 nm
  - » Choose an end-pumped rod oscillator, injection locked to a monolithic master; backup efforts in slabs and fiber lasers
- Overall subsystem system design similar to initial LIGO
  - » Frequency stabilization to fixed reference cavity, 10 Hz/Hz<sup>1/2</sup> at 10 Hz required (10 Hz/Hz<sup>1/2</sup> at 12 Hz seen in initial LIGO)
  - » Intensity stabilization to  $2 \times 10^{-9} \Delta P/P$  at 10 Hz required
  - » 2003:  $1 \times 10^{-8}$  at 10 Hz demonstrated

# Pre-stabilized laser

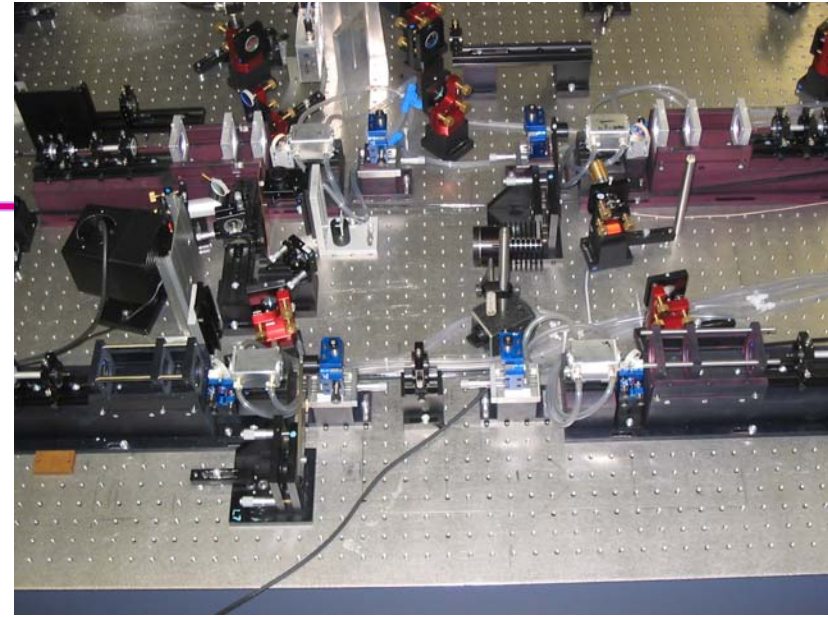

- Max Planck Institute, Hannover leading the Pre-stabilized laser development
  - » Close interaction with Laser Zentrum Hannover
  - » Experience with GEO-600 laser, reliability, packaging
  - » German GEO Group contributing laser to Advanced LIGO
- 2004: Full injection locked master-slave system running, 200 W, linear polarization, single frequency, many hours of continuous operation

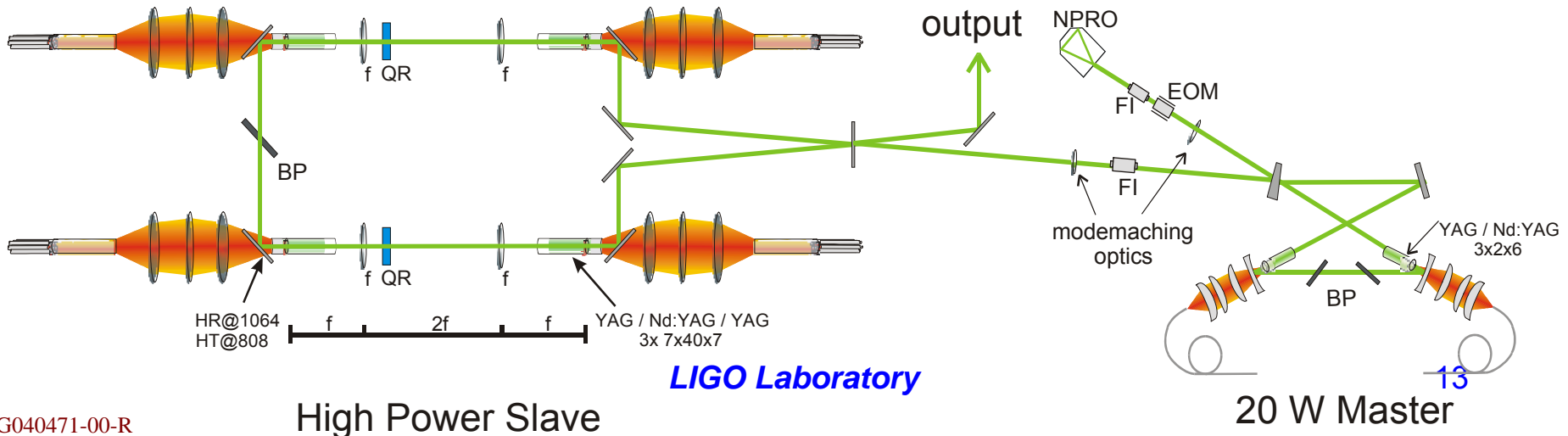

## Input Optics, Modulation

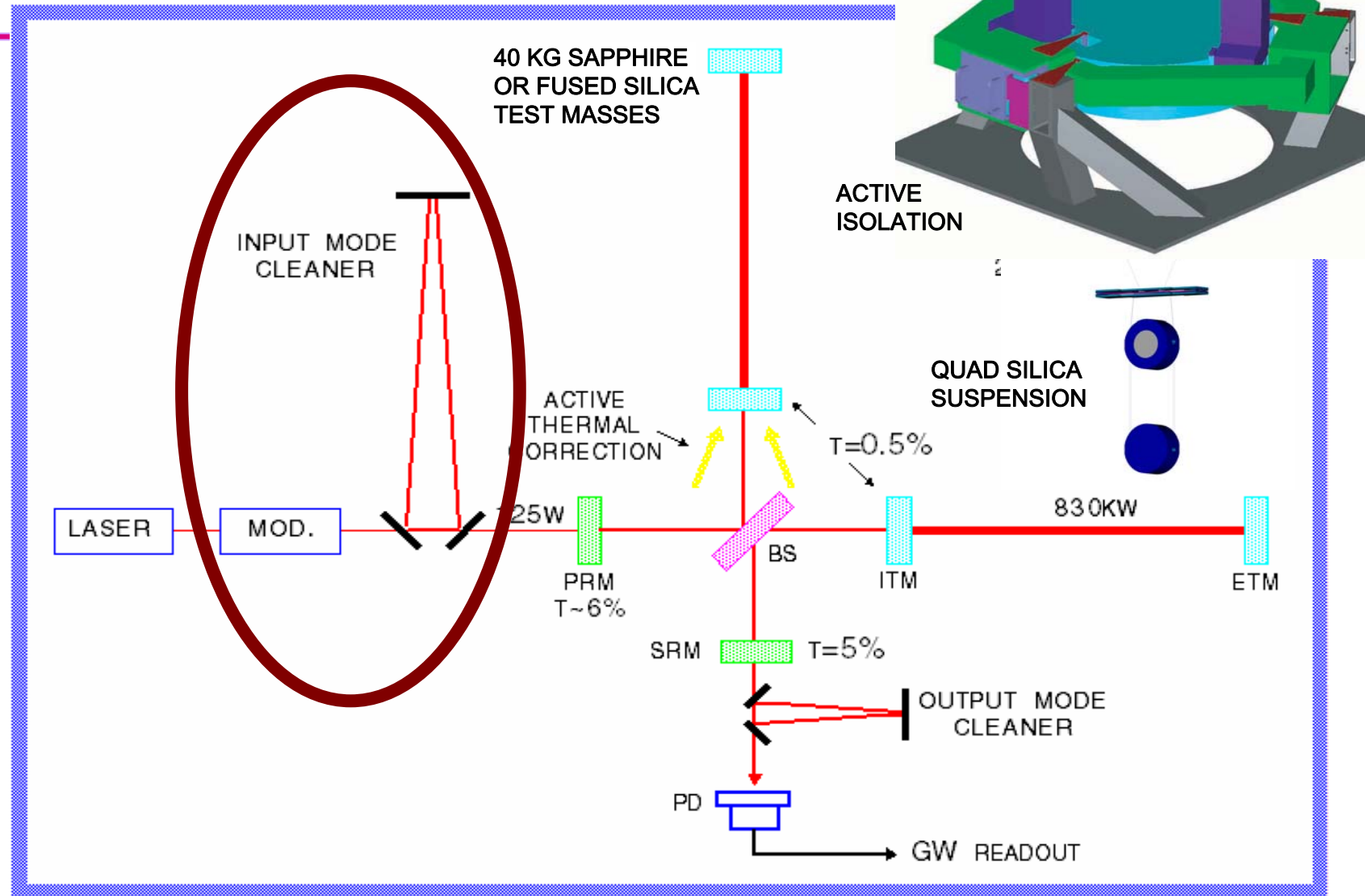



# Input Optics

- Provides phase modulation for length, angle control (Pound-Drever-Hall)
- Stabilizes beam position, frequency with suspended mode-cleaner cavity
- Matches into main optics (6 cm beam) with suspended telescope
- Design similar to initial LIGO but 20x higher power
- Challenges:
  - » Modulators
  - » Faraday Isolators
- University of Florida leading development
  - » As for initial LIGO
- **2004:** LIGO Lab tests of suspension (later)
- **2004:** High-power testing of RTP, RTA
  - » Lab acquisition of 100W test laser, high-power test lab at Livingston
  - » 90W, 700 micron dia beam in RTP – full power for likely configuration
  - » Some anticipated lensing, but no evident damage

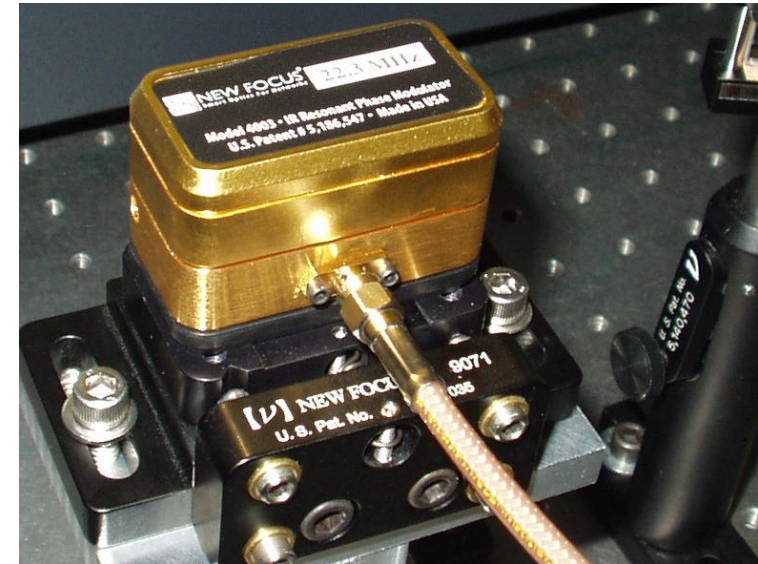

## Test Masses

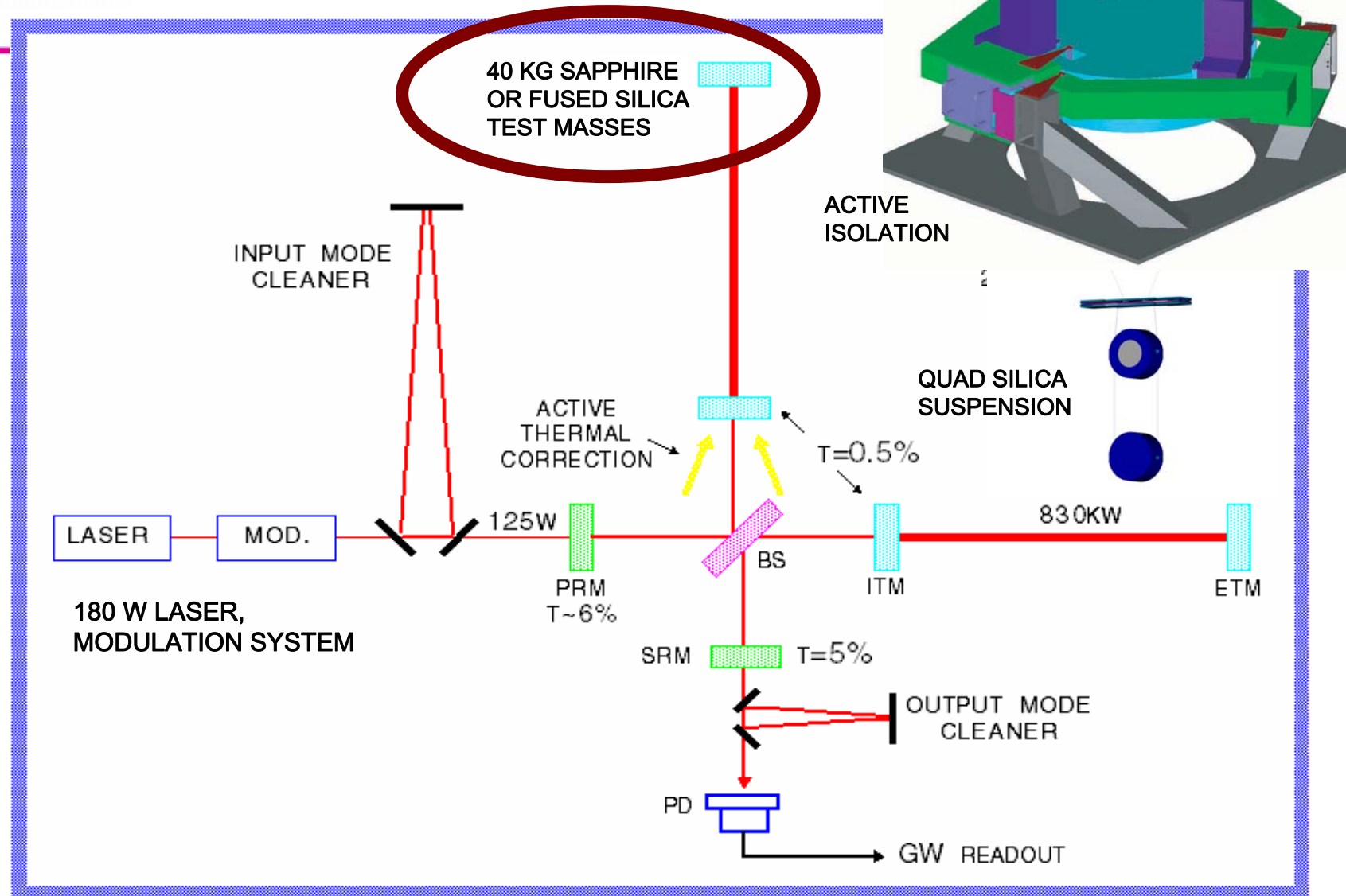



- Absolutely central mechanical *and* optical element in the detector
  - » 830 kW; <1ppm loss; <20ppm scatter
  - »  $2 \times 10^8$  Q; 40 kg
- Fused Silica is the 'traditional' material
- Pursuit of Sapphire as test mass/core optic material; development program launched in 2000
- Low mechanical loss, high Young's modulus, high density, high thermal conductivity all desirable attributes of sapphire
- Higher thermoelastic noise, inhomogeneous absorption, production are challenges
- Significant progress in program
  - » Industrial cooperation
  - » Characterization of both Sapphire and Silica by very active LSC working group



Full-size Advanced LIGO  
sapphire substrate

# Sapphire Substrates

- Fabrication of Sapphire:
  - » Full-size Advanced LIGO boules grown (Crystal Systems); 31.4 x 13 cm
- Most parameters suitable in large pieces
- Bulk Absorption:
  - » 2004: further measurement of large pieces
  - » Average level ~60 ppm, 40 ppm desired
  - » Variations large, relatively abrupt, 10-130 ppm
  - » Annealing shown to reduce losses
- 2004: Growing experience with optical coatings
  - » Indications that net optical absorption is greater for best effort; suspect cleanliness or quality of polish
- Mechanical losses: requirement met
  - » Highest Q measured at >250 million
  - » 2004: Direct measurement of thermoelastic noise

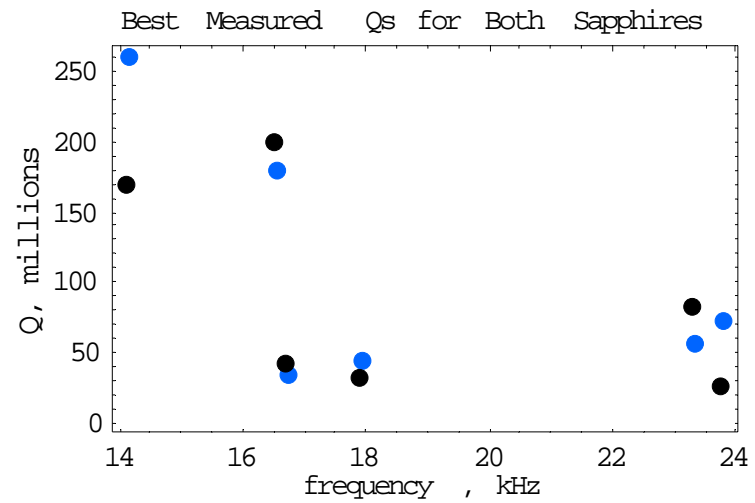
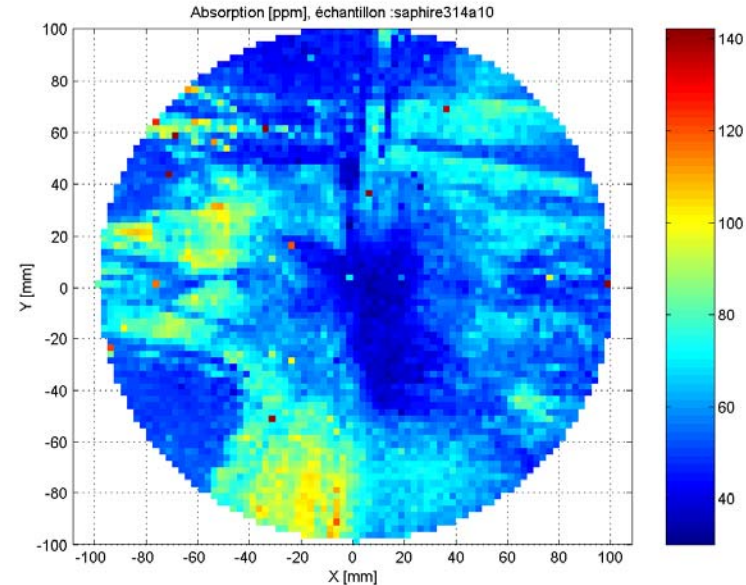

- Thermoelastic noise – fluctuations in mirror surface due to statistical variations in temperature and coefficient of thermal expansion
- Significant in Sapphire, negligible in Fused Silica
- 2004: **Elegant direct measurements** at Caltech confirm model; followup by Japanese group also agrees
- ‘Pins’ the noise level from a Sapphire-based interferometer

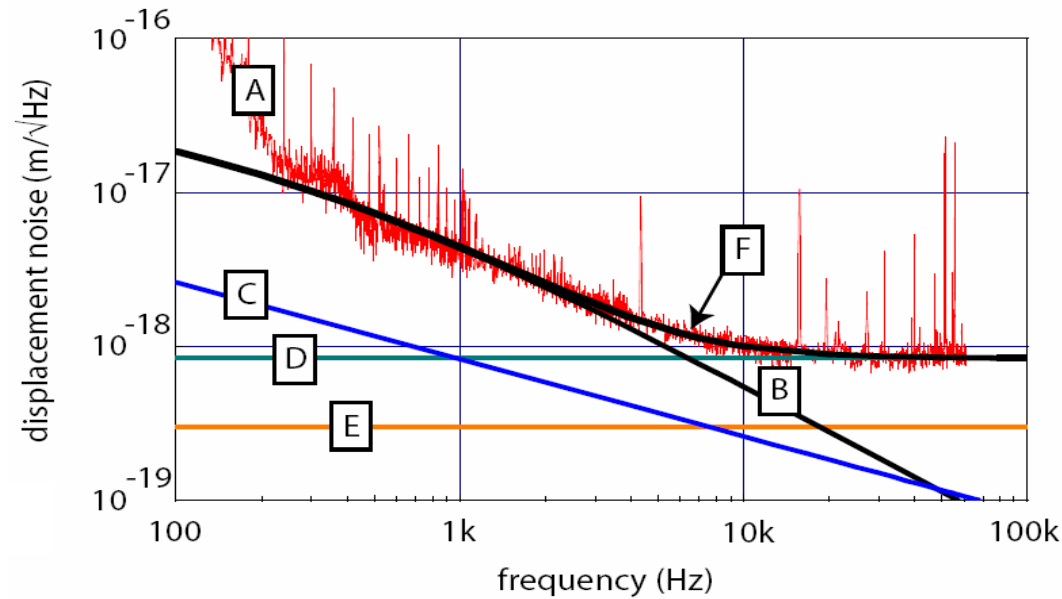
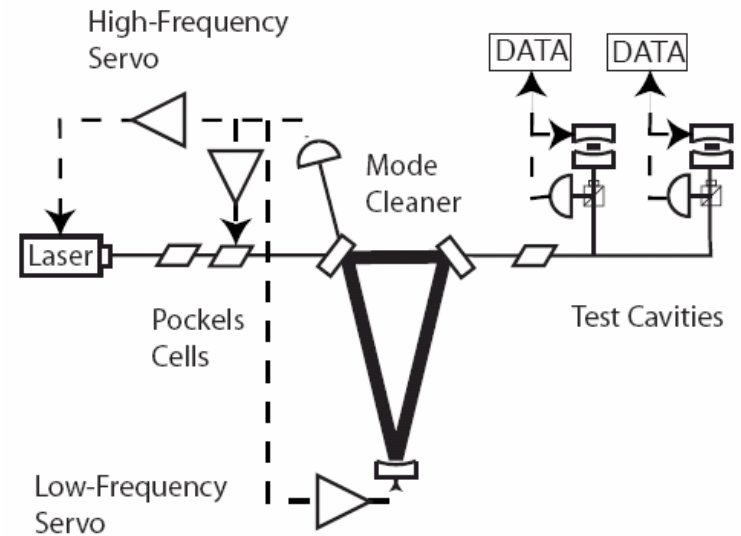

# Fused Silica Substrates

- Production of 40 kg pieces with absorption, homogeneity straightforward
- Familiar; fabrication, polishing, coating processes well refined
- Development program to reduce mechanical losses, understand frequency dependence
  - » Annealing proven on small samples, needs larger sample tests and optical post-metrology
- 2004: Assembly of available data of Q vs. Freq, volume/surface
  - » Agreement with theory for relaxation process in silica
- Greater range of performance between pessimistic and optimistic parameters

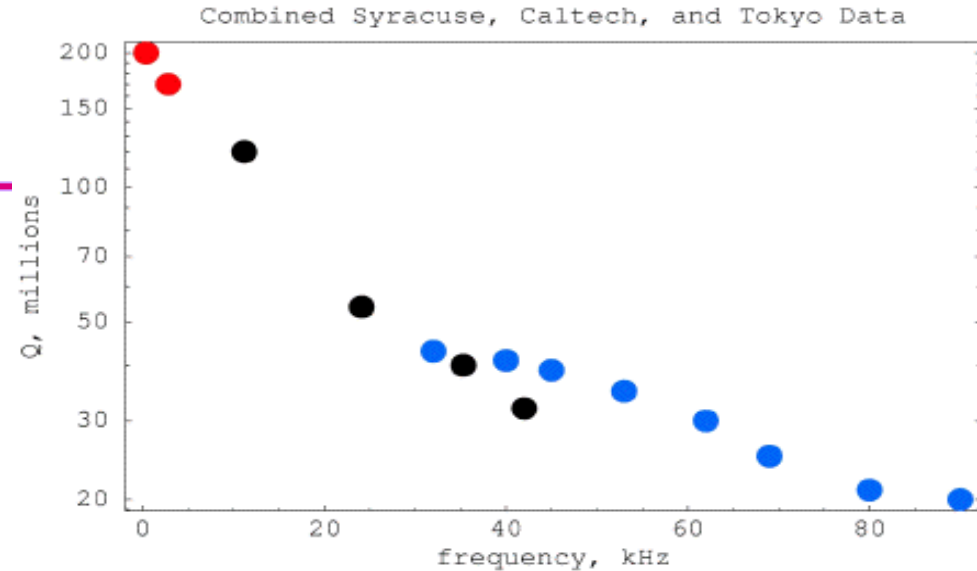

Summary:  $\phi = 6.18e-09 (S/V) + 7.88e-12 f^{0.77} + 0.827 \phi_{th}$

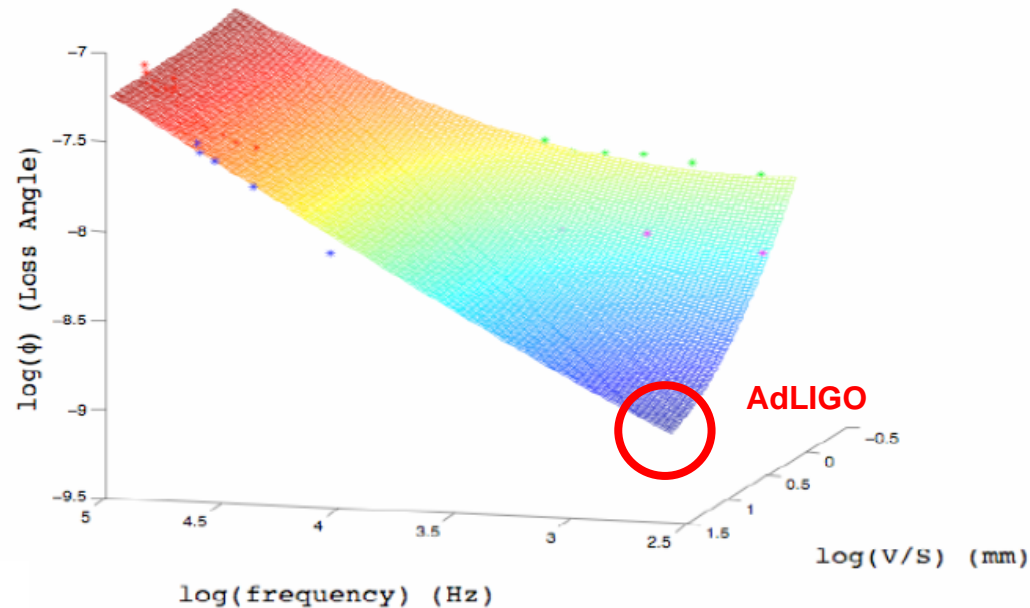



# Test Mass downselect

- Delayed
  - » Driven by suspension schedule (UK funding)
  - » Always possible to learn more
- Astrophysics advantages for both substrates
- Risks in production greater for sapphire
- Recent new ingredient: thermal compensation
- Basic suspension design could accommodate either substrate
- Recommendation in coming months

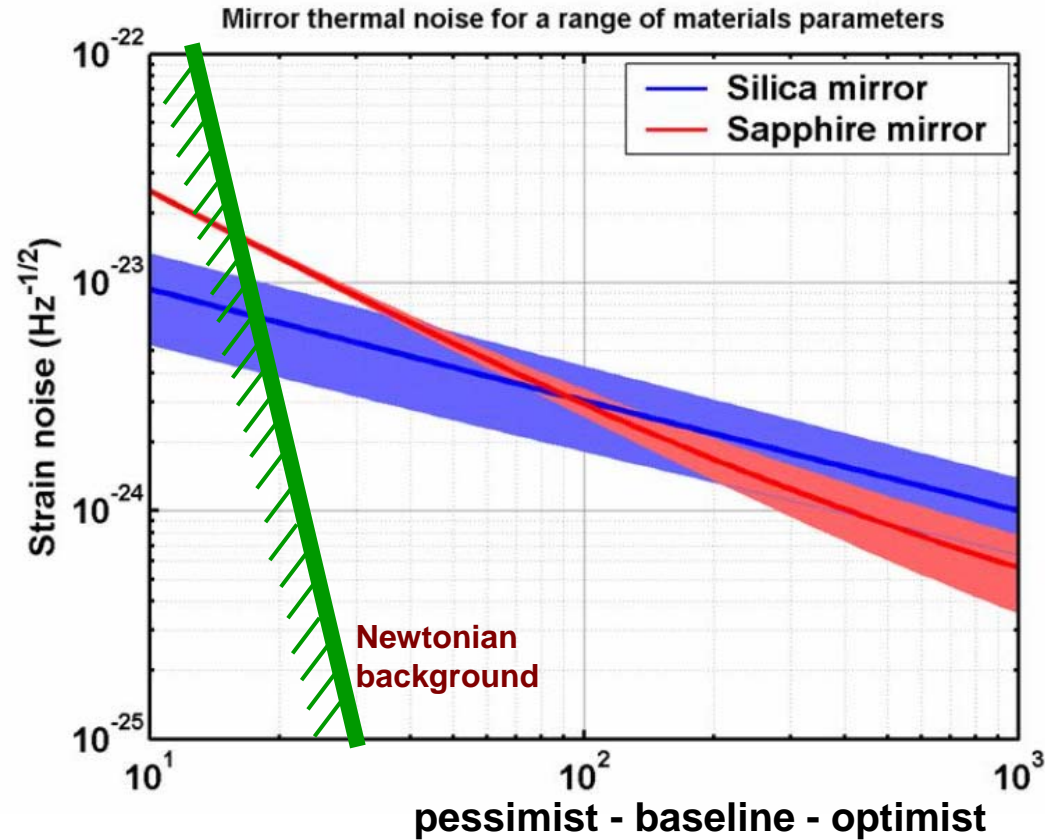

NS-NS	sapphire	165 - 191 - 208
Mpc	silica	153 - 191 - 254

10Ms BHBH	sapphire	762 - 923 - 1016
Mpc	silica	775 - 1052 - 1510

XRB, 730 Hz	sapphire	9.6 - 4.5 - 6.8
$\times 10^{-25}$	silica	16 - 7.2 - 12

Stochastic	sapphire	1.7 - 1.7 - 1.6
$\times 10^{-9}$	silica	1.9 - 1.2 - 1.1

## Mirror coatings

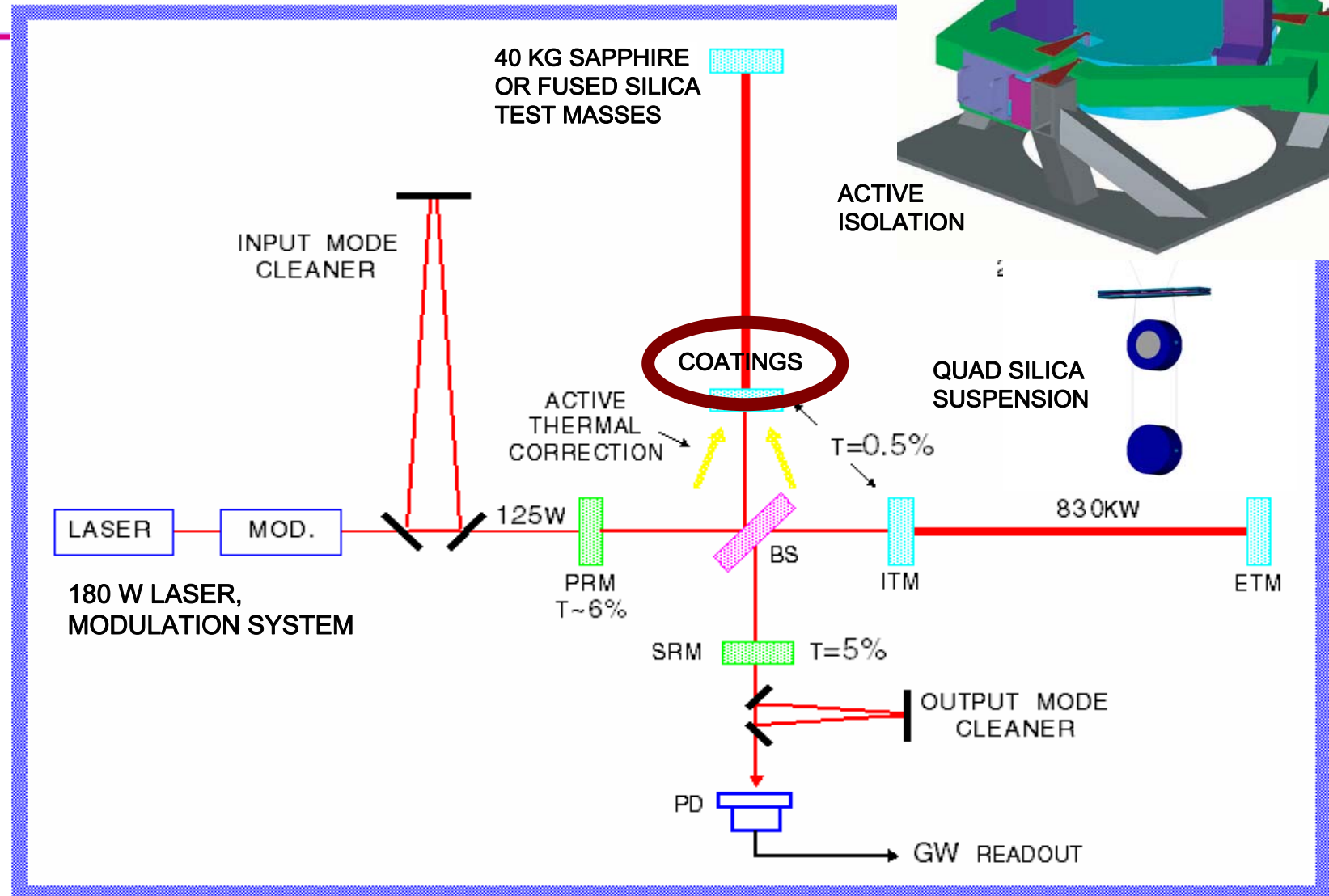



# Test Mass Coatings: Thermal noise

- R&D mid-2000: Thermal noise due to coating mechanical loss recognized; LSC program put in motion to develop low-loss coatings
  - » Series of coating runs – materials, thickness, annealing, vendors
  - » Measurements on a variety of samples
- $\text{Ta}_2\text{O}_5$  identified as the principal source of loss
- Direct measurements confirm theory (Caltech TNI, similar Japanese experiment)

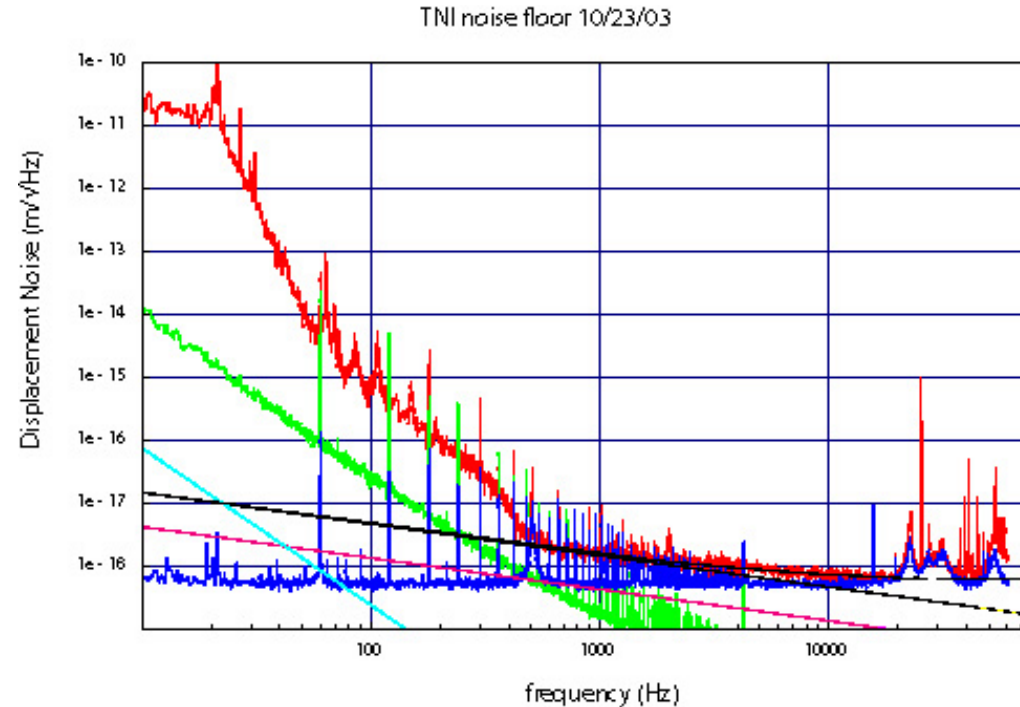

# Test mass coatings: Thermal noise

- 2004: Evidence of frequency dependence of coating mechanical loss
  - » Coating loss lower at lower (GW) frequencies
- 2004: Increasing Titania dopant reduces mechanical loss (LMA)
  - » So far, loss  $2.7 \cdot 10^{-4} \rightarrow 1.6 \cdot 10^{-4}$  ; may be the point of diminishing returns
- 2004: Secondary ion-beam bombardment reduces loss (CSIRO)
  - » So far, loss  $4.4 \cdot 10^{-4} \rightarrow 3.2 \cdot 10^{-4}$
- Both approaches still require tests for optical properties, optimization, checks if compatible and if both work at lower losses
- Seems likely that we can approach goal of  $5 \cdot 10^{-5}$  with such incremental improvements

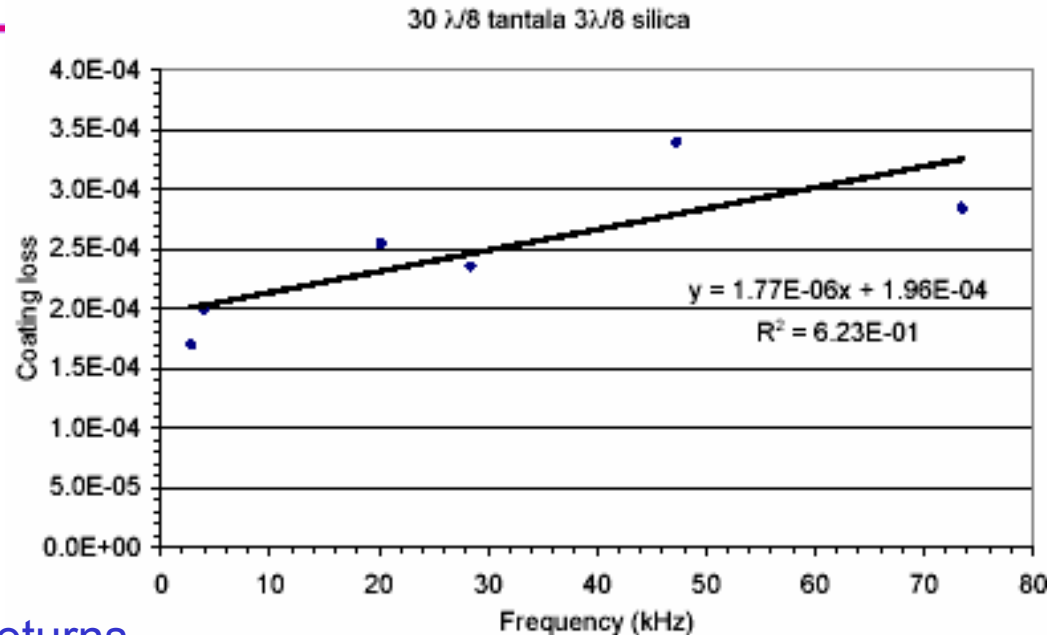



- Require low average absorption (0.5 ppm) to limit gaussian-shaped thermal distortion
- Also require freedom from point absorbers to limit inhomogeneous distortion
- 2004: Maps of low-absorption coatings measured in same class-10 room as coating machine (LMA)
- Best results: Average absorption 0.32 ppm
- Only 10 points greater than 0.5 ppm
- Doped coatings and coatings on sapphire need work to match this result (few samples)

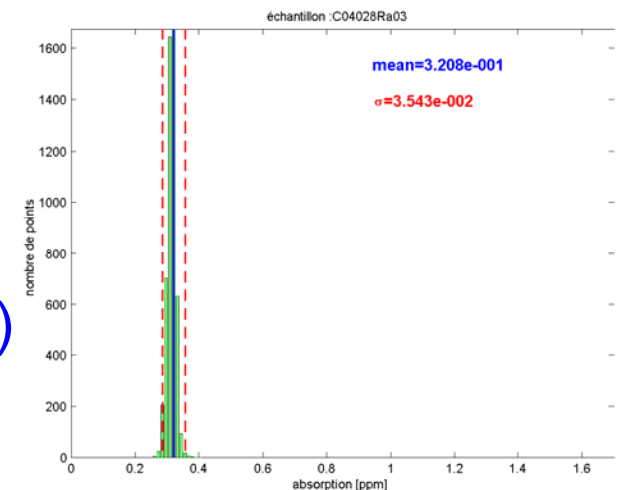
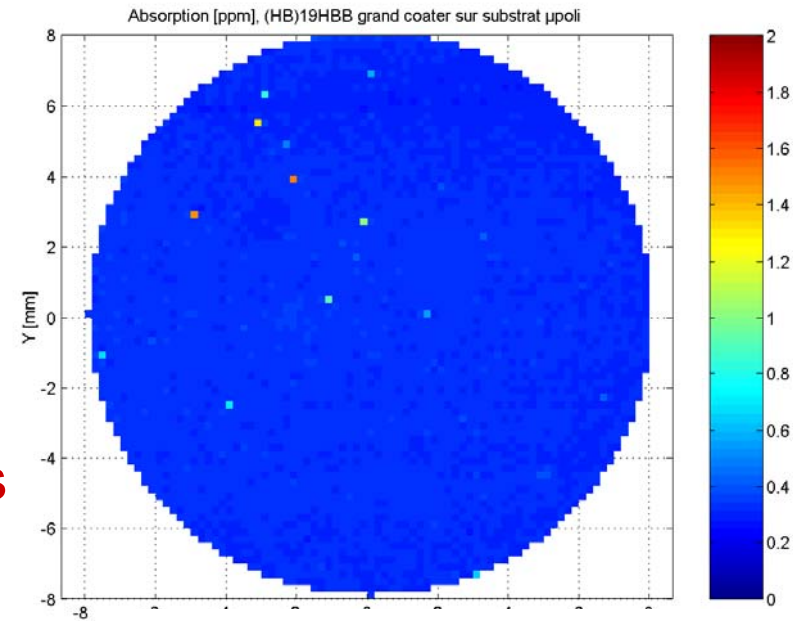

## Thermal Compensation

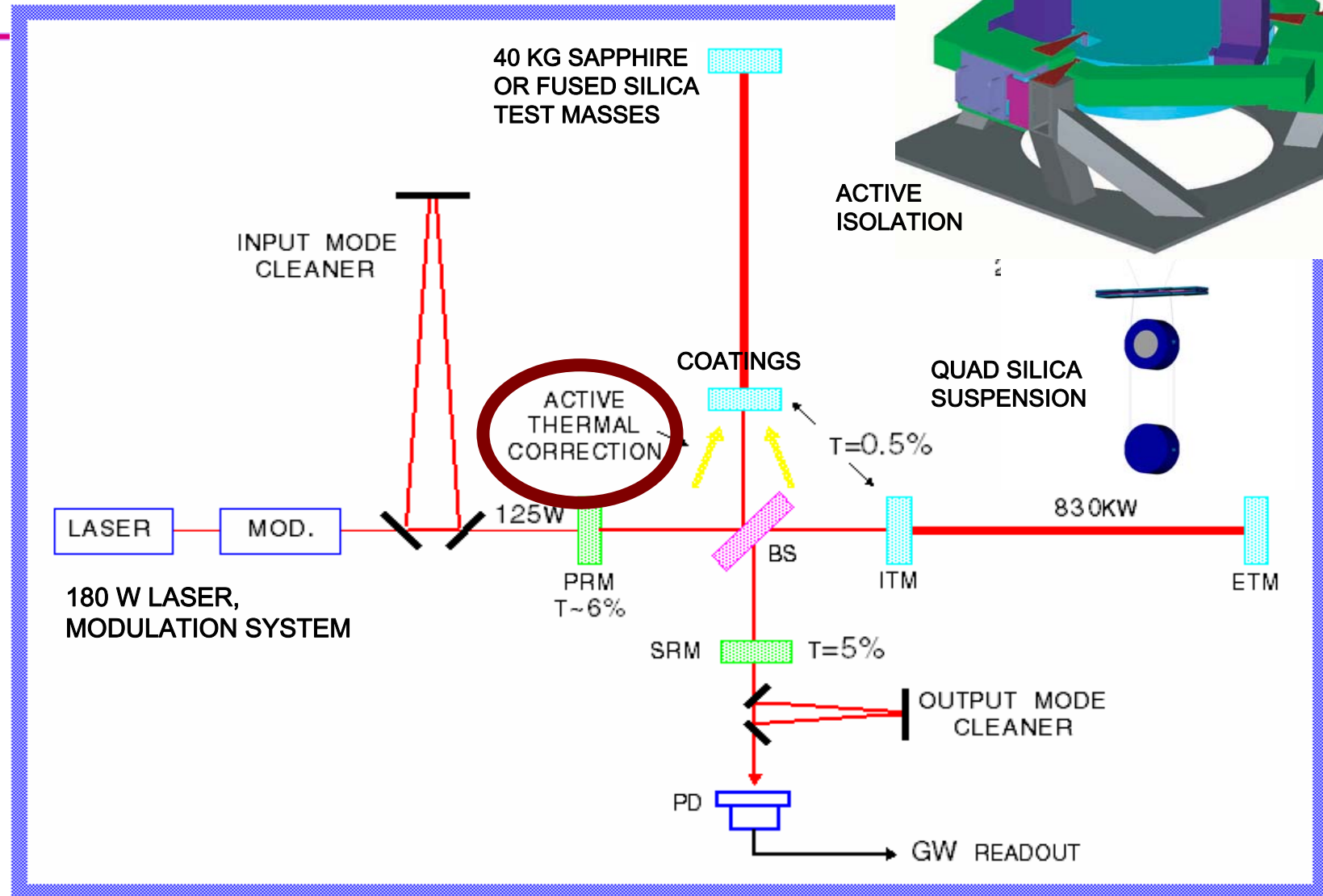

# Active Thermal Compensation

- Removes excess 'focus' due to absorption in coating, substrate
- Allows optics to be used at all input powers
- Sophisticated thermal model ('Melody') developed to calculate needs and solution
- 2004: Successful application to initial LIGO using new 'staring' approach
- 2004: Modeling, investigating effect on sidebands and point absorbers
  - » Silica and Sapphire behave differently due to thermal expansion, thermal conductivity differences;
  - » Some (dis)advantages for each, with Silica better on balance for 'clean' coatings

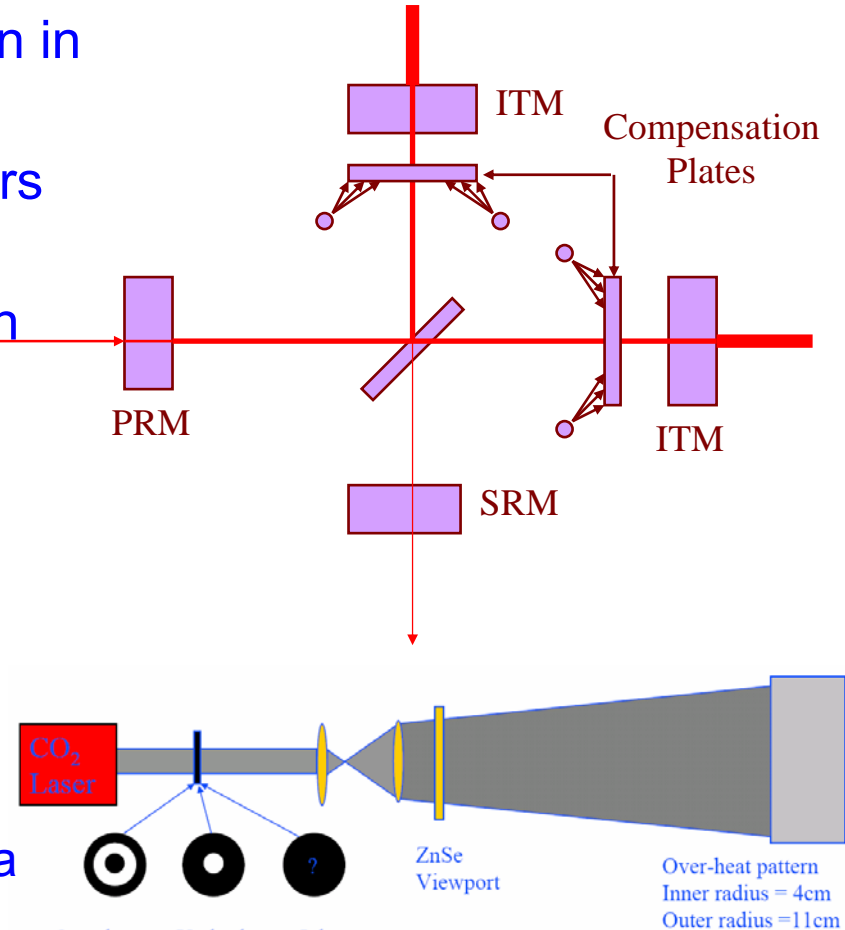

## Seismic Isolation

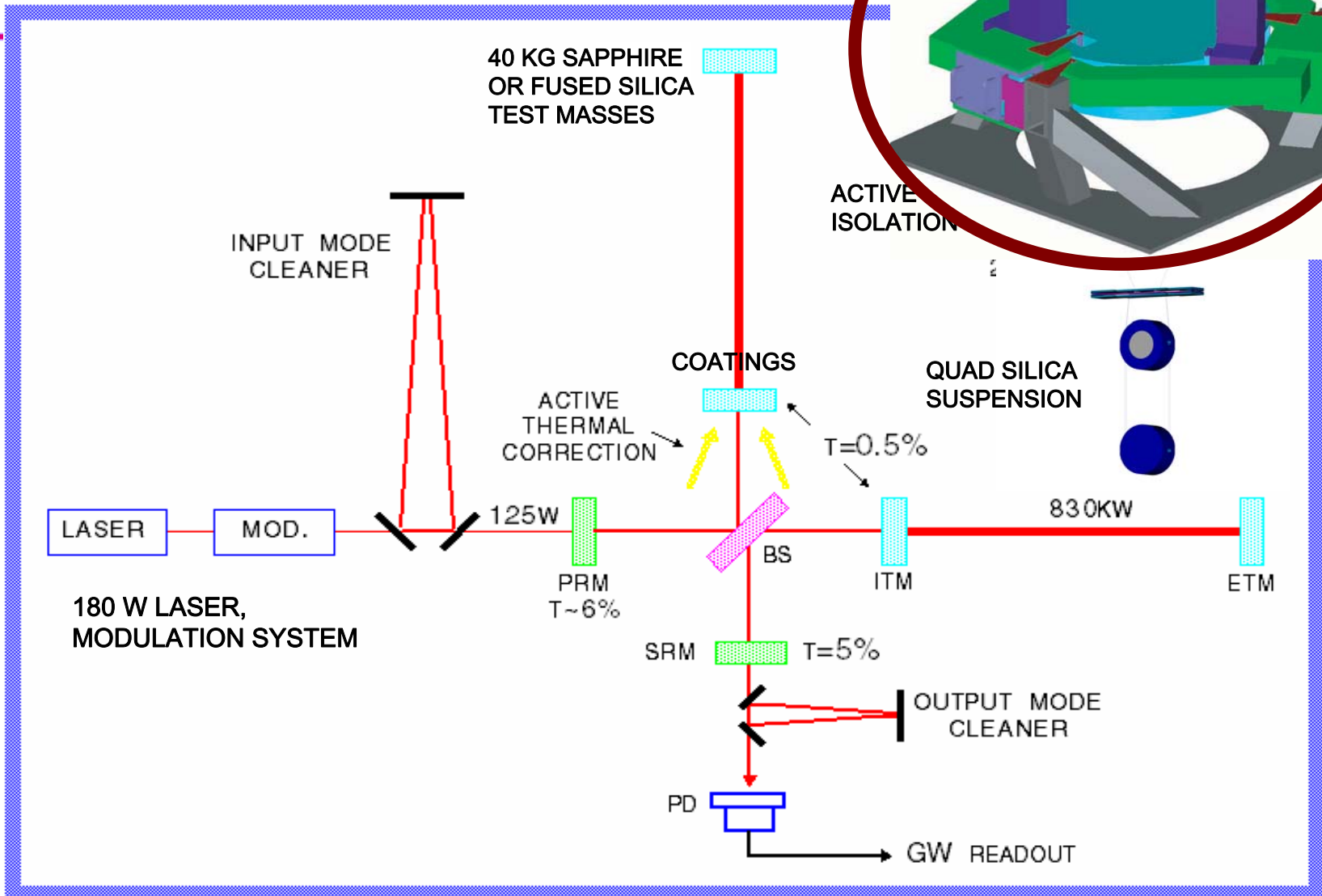
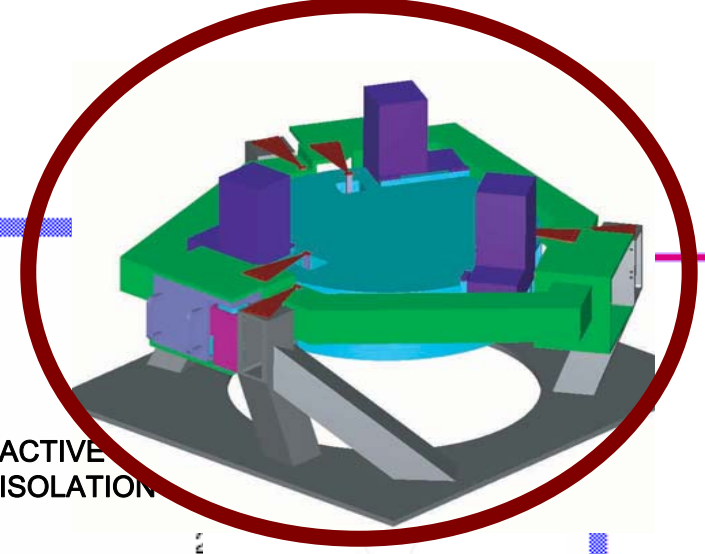

# Isolation: Requirements

- Render seismic noise a negligible limitation to GW searches
  - » Newtonian background will dominate for frequencies less than  $\sim 15$  Hz
  - » Suspension and isolation contribute to attenuation
- Reduce or eliminate actuation on test masses
  - » Actuation source of direct noise, also increases thermal noise
  - » Acquisition challenge greatly reduced
  - » In-lock (detection mode) control system challenge is also reduced

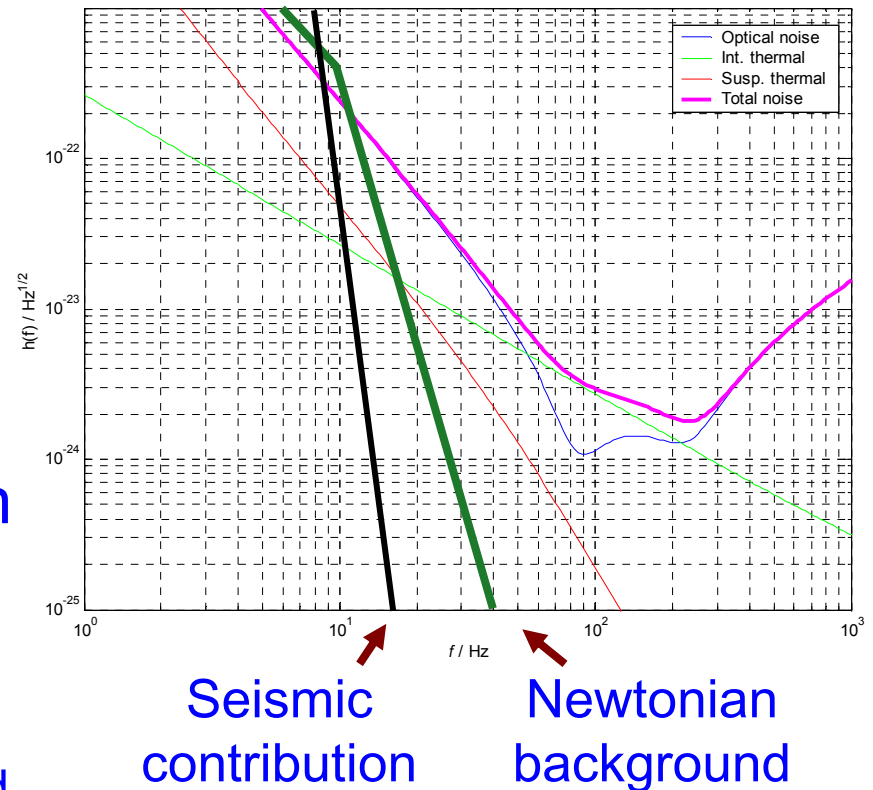

# Isolation: multi-stage solution

- Choose an active approach:
  - » high-gain servo systems, two stages of 6 degree-of-freedom each
  - » External hydraulic actuator pre-isolator
  - » Allows extensive tuning of system after installation, operational modes
- Lead at LSU, strong Stanford participation
- 2004: External pre-isolator installed, in commissioning at Livingston
  - » System performance meets initial needs
  - » Exceeds Advanced LIGO requirements

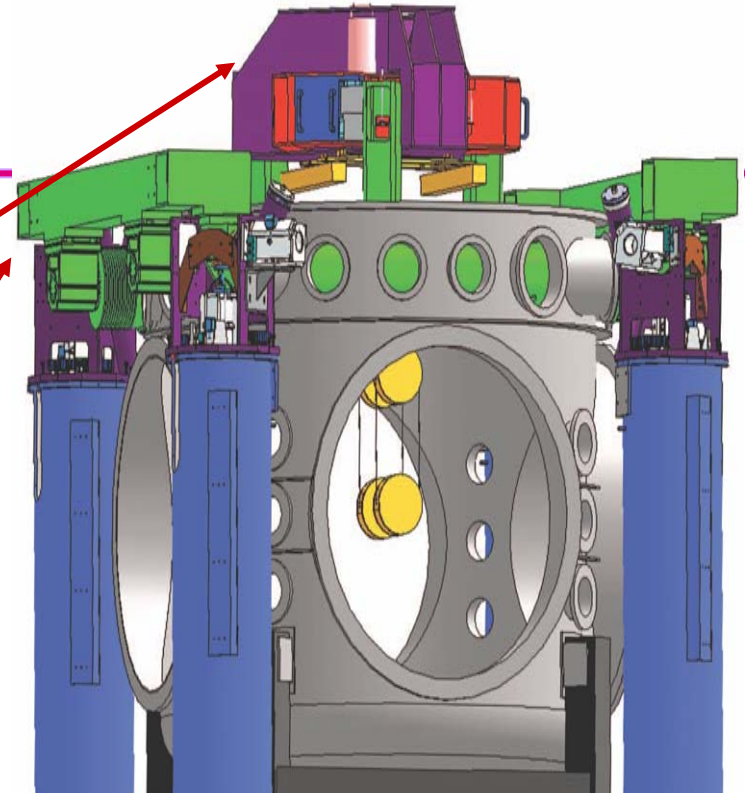

X-arm length disturbance, noisy afternoon

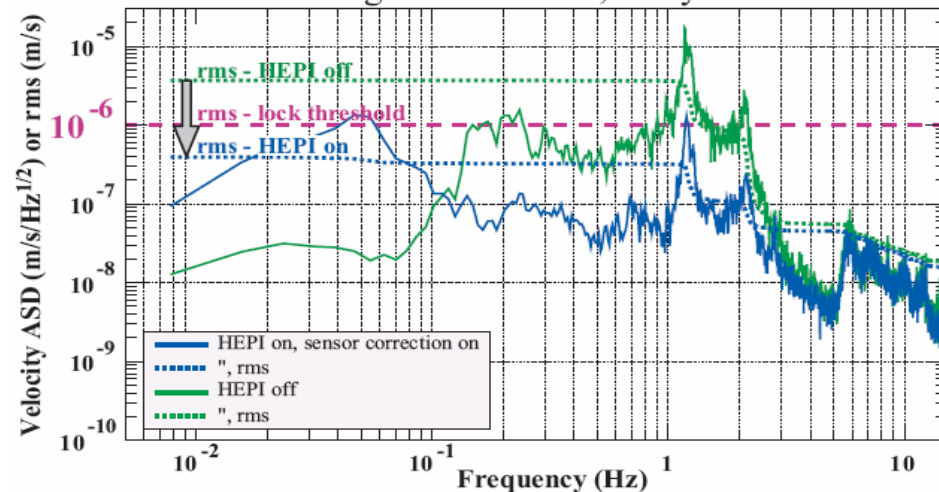



# Full-scale prototypes

- 2004: Technology Demonstrator at Stanford in characterization
  - » 1000x Isolation at GW frequencies demonstrated
  - » 1-10 Hz performance next
- Vendor contract for next generation prototype design and prototypes: significant progress in design, but cost increases and schedule delays
- LIGO has chosen to terminate contract at end of design, with plan to take advantage of juncture to review subsystem status and approach and re-bid accordingly

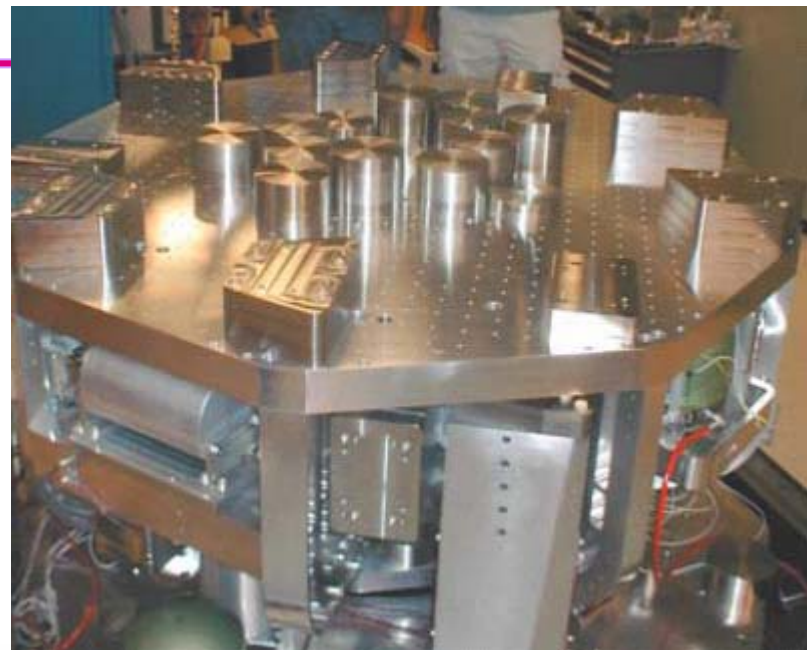

ETF Performance: X

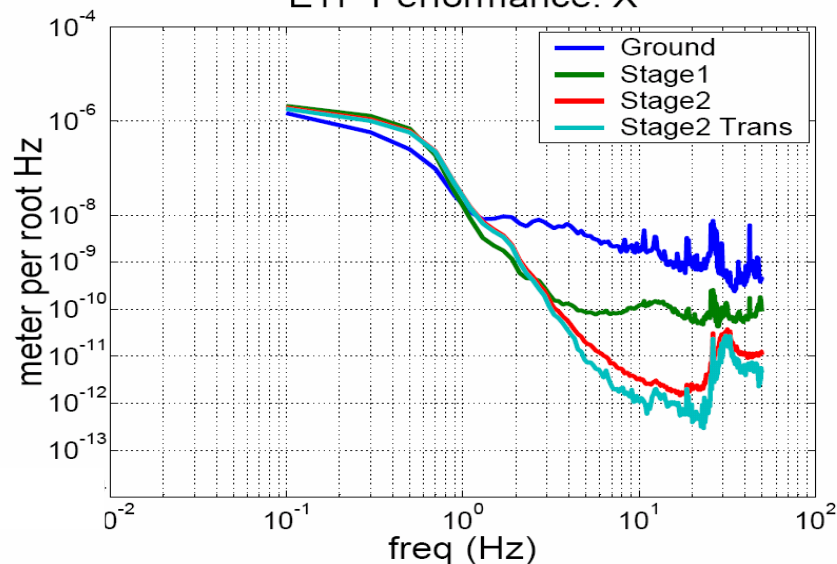

## Suspension

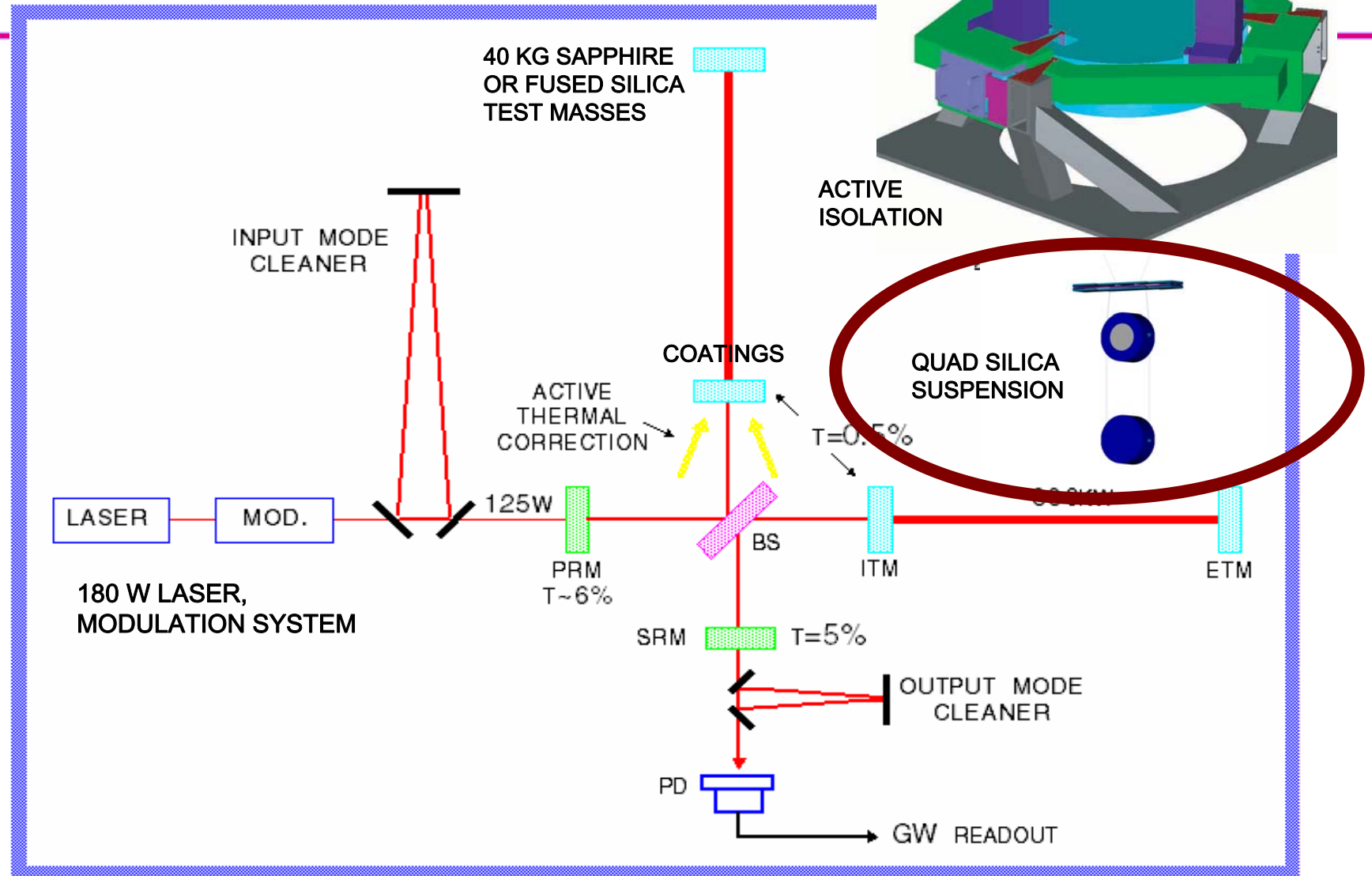



# Suspensions: Test Mass Quads

- Adopt GEO600 monolithic suspension assembly
- Requirements:
  - » minimize suspension thermal noise
  - » Complement seismic isolation
  - » Provide actuation hierarchy
- Quadruple pendulum design chosen
  - » Fused silica fibers, bonded to test mass
  - » Leaf springs (VIRGO origin) for vertical compliance
- PPARC funding approved for Adv LIGO (2003)
  - » significant financial, technical contribution; quad suspensions, electronics, and some substrates
  - » Quad lead in UK; U Glasgow, Birmingham, Rutherford
- **2004: Detailed design underway**
  - » 'Mass catcher' frame
  - » Interface with Seismic Isolation
  - » Finite element modeling
- **2004: CO<sub>2</sub> fiber drawing, welding in development**

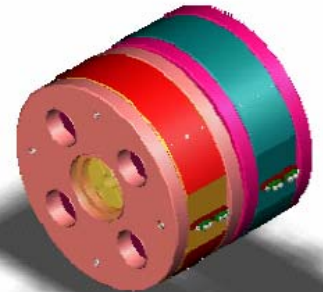
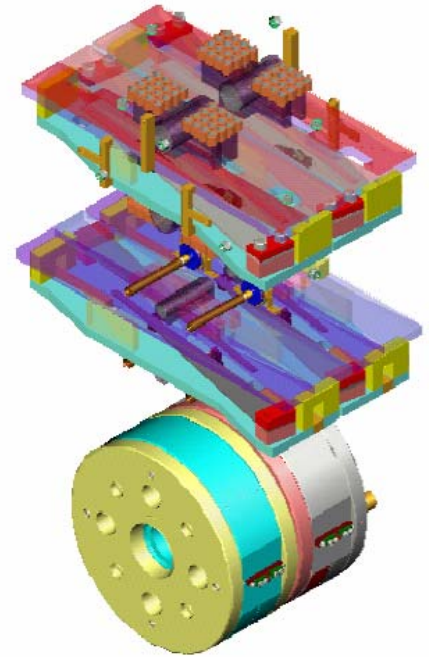

# Suspensions: Triples

- Triple suspensions for auxiliary optics
  - » Relaxed performance requirements
- Uses same fused-silica design, control hierarchy
- 2004: Mode Cleaner suspension installed in LASTI full-scale testbed
- Uses HEPI as 'shake table' for excitation
- Characterization of modes, isolation match model nicely



## GW Readout

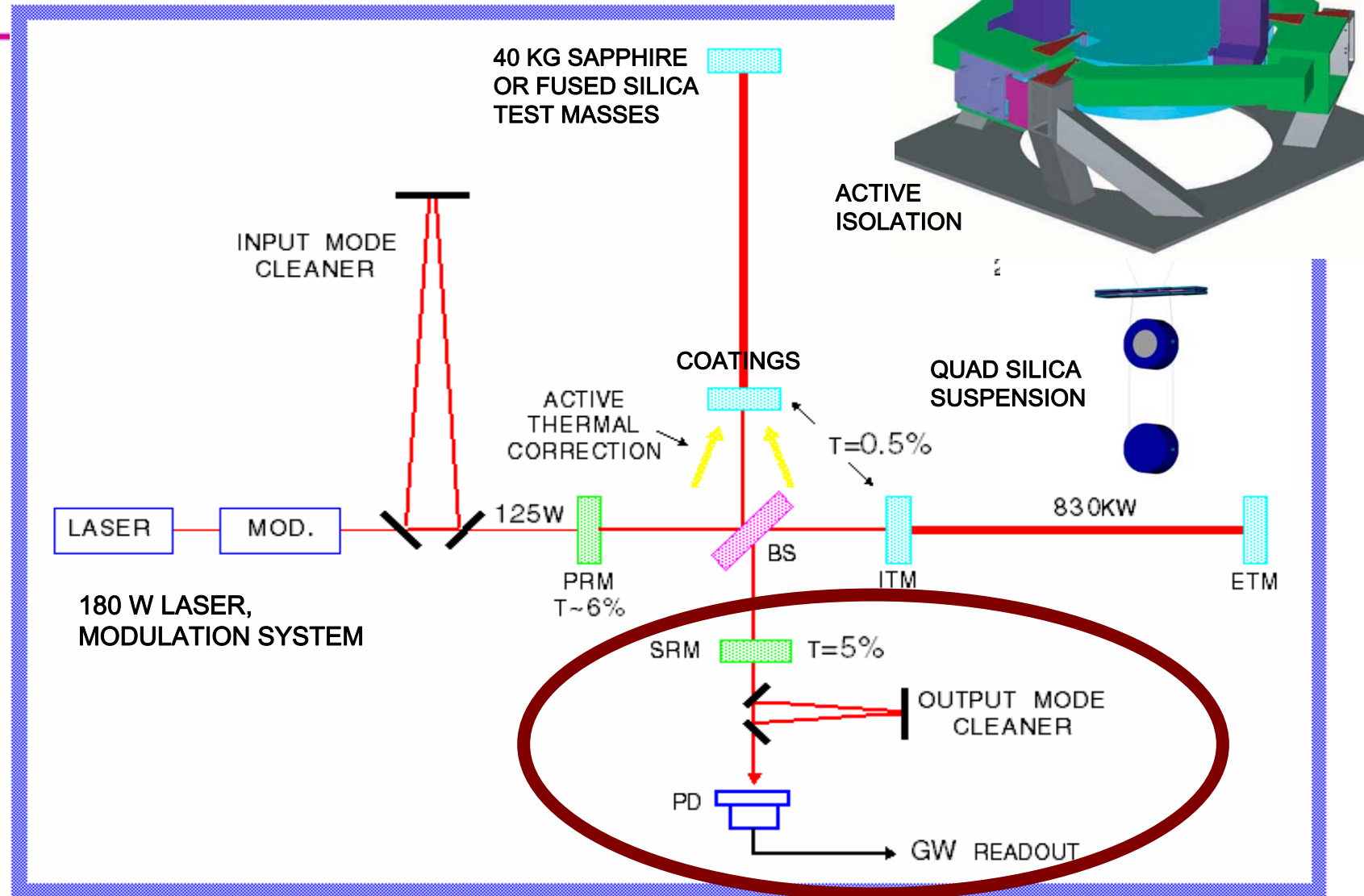

- Signal recycled Michelson Fabry-Perot configuration
  - » Offers flexibility in instrument response
  - » Can also provide narrowband response
  - » Critical advantage: can distribute optical power in interferometer as desired
- DC rather than RF for GW sensing
  - » Offset  $\sim 1$  picometer from interferometer dark fringe
  - » Best SNR, simplifies laser, photodetection requirements
- 2004: Caltech 40m prototype giving guidance to design
  - » Exploring modulation techniques; adoption of Mach-Zehnder design to avoid 'sidebands on sidebands'
  - » Locking of Dual-recycled Michelson

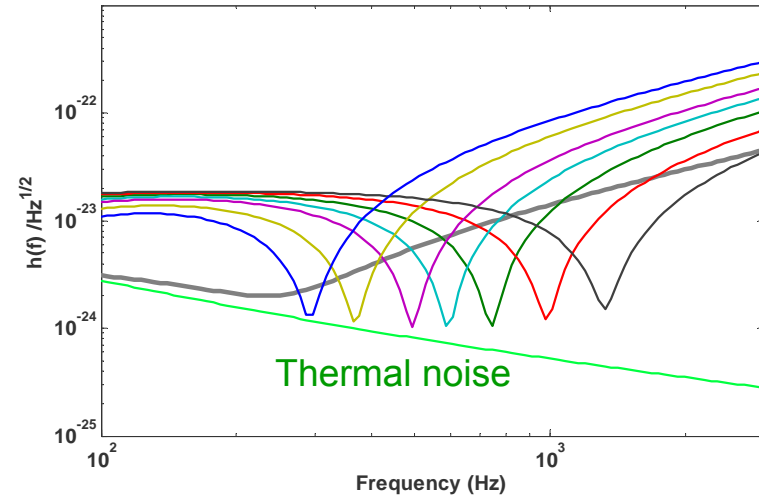



# System testing

- Initial LIGO experience: thorough testing off-site necessary
- Very significant feature in R&D plan: testing of accurate prototypes in context
- Two major facilities:
  - » MIT LASTI facility – full scale tests of seismic isolation, suspensions, laser, mode Cleaner
    - 2004: pre-isolator development, installation and test of triple suspension
  - » Caltech 40m interferometer – sensing/controls tests of readout, engineering model for data acquisition, software
    - 2004: start of research phase
- Support from LSC testbeds
  - » Gingin – thermal compensation
  - » Glasgow 10m – readout
  - » Stanford ETF – seismic isolation
  - » GEO600 – much more than a prototype!



# Baseline plan

- Initial LIGO Observation at design sensitivity 2005 – 2010
  - » Significant observation within LIGO Observatory
  - » Significant networked observation with GEO, VIRGO, TAMA
- Structured R&D program to develop technologies
  - » Conceptual design developed by LSC in 1998
  - » R&D progressing toward Final Design phase
- 2003: Proposal for fabrication, installation
  - » NSF considered proposal and timeline
- 2004: NSB recommends Advanced LIGO for funding consideration
- 2007: First (possible) funds arrive
  - » Test Mass material, seismic isolation fabrication long leads
  - » Prepare a 'stock' of equipment for minimum downtime, rapid installation
- 2010: Start initial decommissioning/installation
  - » Baseline is a staggered installation, Livingston and then Hanford
- 2013: Coincident observations
  - » At an advanced level of commissioning

# Recommendations from the 2003 Annual Review

- The R&D program for Advanced LIGO is making good progress. The installation of the active seismic isolation system at the Livingston Observatory will provide a critical test of this key subsystem of the Advanced LIGO plan while making it possible for the Livingston site to maintain lock during times of high ambient seismic noise from human activity. This is a strong confirmation of the advantages of supporting a vigorous R&D program while commissioning and operating the interferometers.
  - » **Agreed! HEPI successfully deployed. Further examples: thermal compensation applied to initial LIGO, output mode cleaner in preparation**
- The selection process for the high power laser system is likely to provide a laser system meeting the power and stability requirements for Advanced LIGO. It is, however, important to maintain a backup option for this critical system.
  - » **Continued effort at Stanford and Adelaide on LIGO-compatible lasers; continued success with the selected laser, demonstrating power requirement of 200 W.**
- Either silica or sapphire could be successfully used as the substrate for the test masses at their current performance levels assuming thermal compensation. The Panel supports the selection of sapphire as the test mass substrate material if no intervening results suggest otherwise.
  - » **Further research indicates comparable performance from fused silica and sapphire, with potentially fewer risks with fused silica. Choice imminent.**
- Coating mechanical loss remains the largest known mechanism of degradation of Advanced LIGO from design specifications. The planners are to be commended for seeking out wide expertise for solving this demanding problem. Immediate attention should be focused on the two most promising avenues, titania-doped tantala and hafnia.
  - » **Titania-doped tantala has been a successful approach for incremental improvements. Efforts to date with hafnia have led to defective coatings (bubbles), but we will pursue this approach.**