

Development of Fused Silica Suspensions for Advanced Gravitational Wave Detectors

LSC Virgo Meeting - Pasadena
19th March 2008

Alastair Heptonstall
LIGO

*Heptonstall, Barton, Cagnoli, Cumming, Faller, Hammond, Hough,
Jones, Kumar, Martin, Mittleman, Rowan, Strain, Tokmakov, van Veggel*

Monolithic suspensions for advanced detectors

- Development of monolithic suspensions is based on experience from the GEO600 suspensions
- This talk will cover aspects of production and testing of suspension elements suitable for Adv. LIGO and potential upgrades to Virgo
- The criteria that must be met by ribbon fibres for Adv. LIGO:
 - Breaking stress > 2.4 GPa
 - Intrinsic loss $< 3 \times 10^{-11}/t$, where t is the thickness of the ribbon
- We will present an update on the status of development since the last LSC

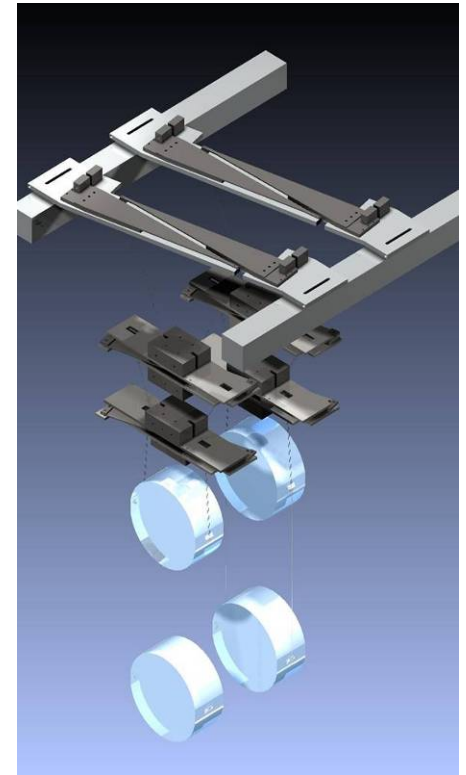
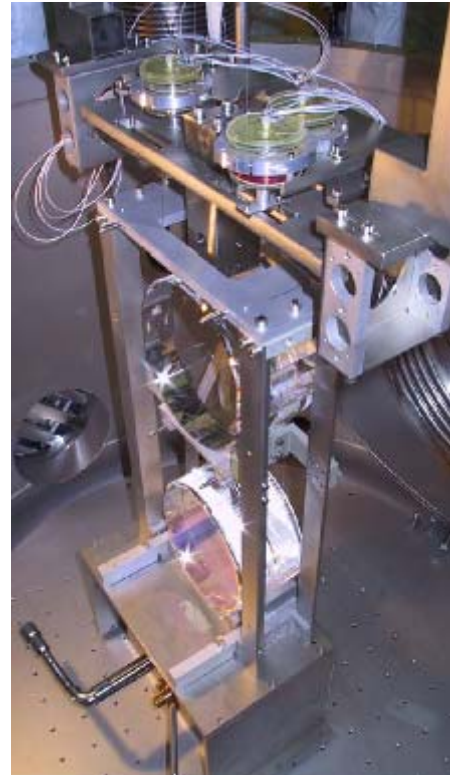

Heptonstall, Barton, Cagnoli, Cumming, Faller, Hammond, Hough, Jones, Kumar, Martin, Mittleman, Rowan, Strain, Tokmakov, van Veggel

LASTI Installation - Fibre Pulling Machine

- Installation of the fibre pulling machine began in December 2007
- Main mechanical parts installed over two weeks in December
- Labview / electrical installation completed in January
- Laser stabilisation controller implemented in January
- First fibres produced in February
- Work now progressing on improving the ribbon 'recipe'



Heptonstall, Barton, Cagnoli, Cumming, Faller, Hammond, Hough, Jones, Kumar, Martin, Mittleman, Rowan, Strain, Tokmakov, van Veggel

LASTI Installation - Fibre Pulling Machine

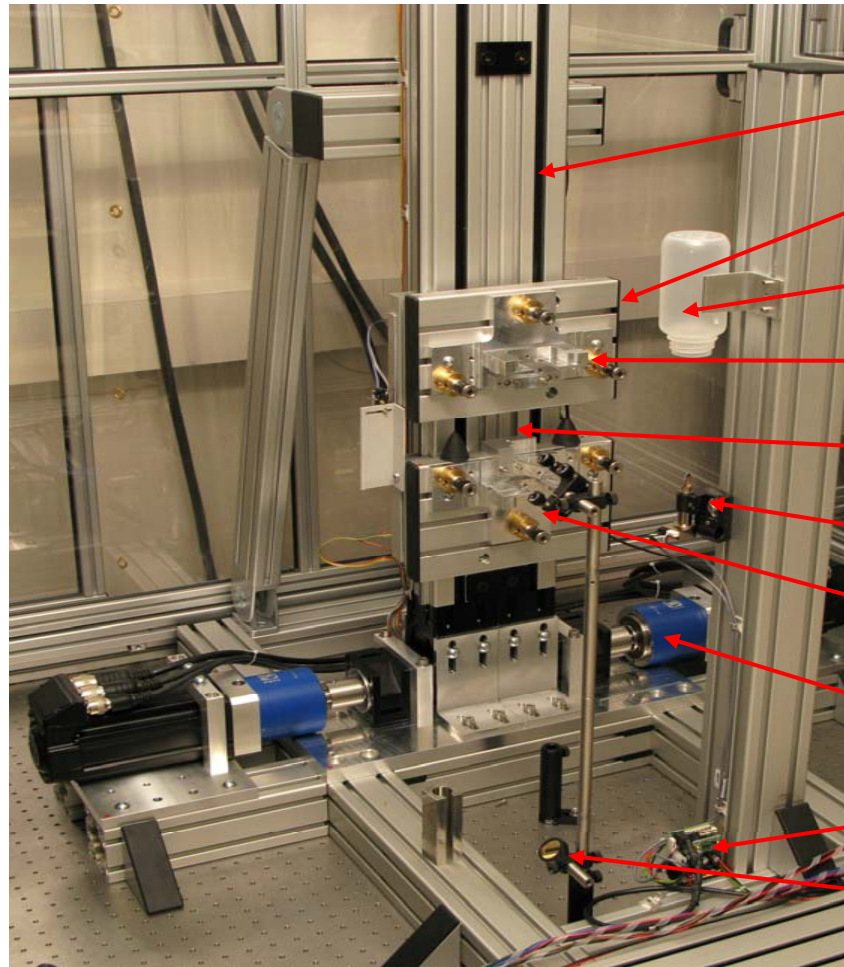

twin ballscrew unit

linear encoder

mirror cover

upper arm

heating zone

galvanometer

lower arm

motors

servo unit

periscope

*Heptonstall, Barton, Cagnoli, Cumming, Faller, Hammond, Hough, Jones,
Kumar, Martin, Mittleman, Rowan, Strain, Tokmakov, van Veggel*

LASTI Installation

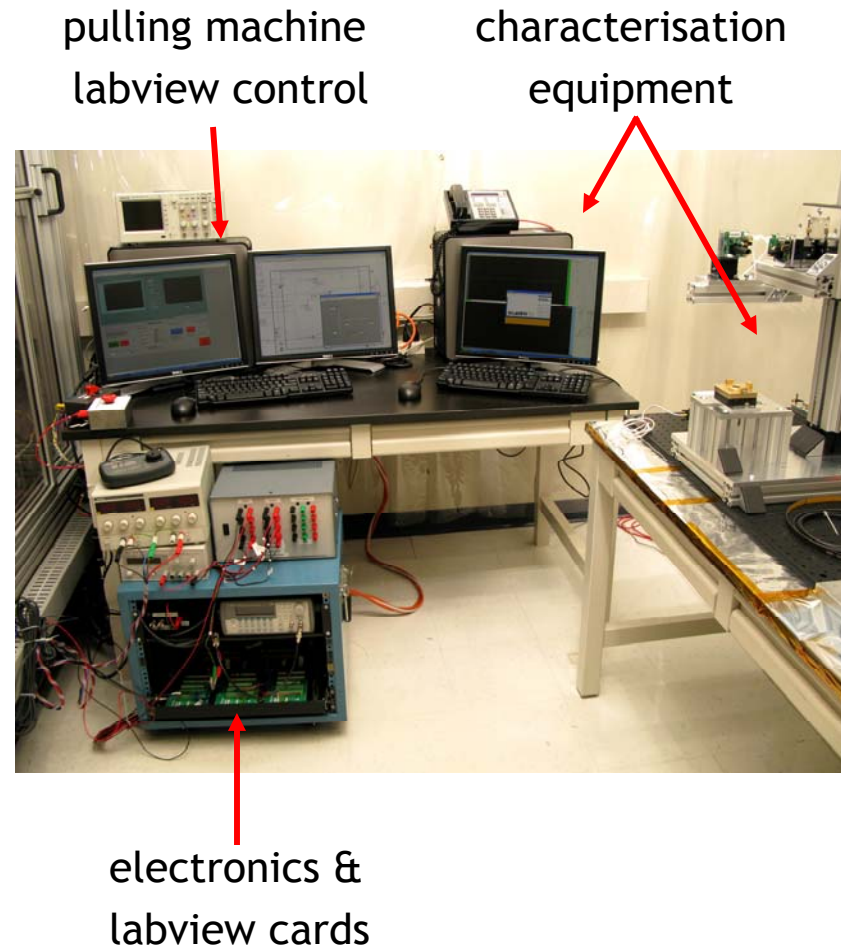
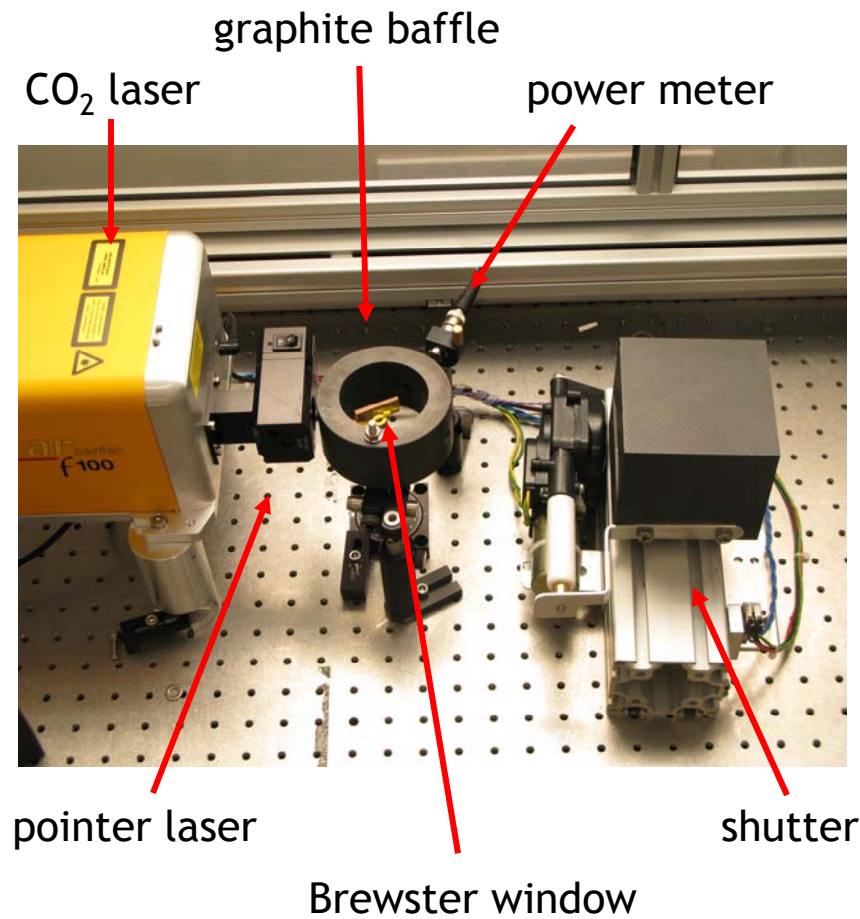

Heptonstall, Barton, Cagnoli, Cumming, Faller, Hammond, Hough, Jones, Kumar, Martin, Mittleman, Rowan, Strain, Tokmakov, van Veggel

LASTI laser fibre pulling machine

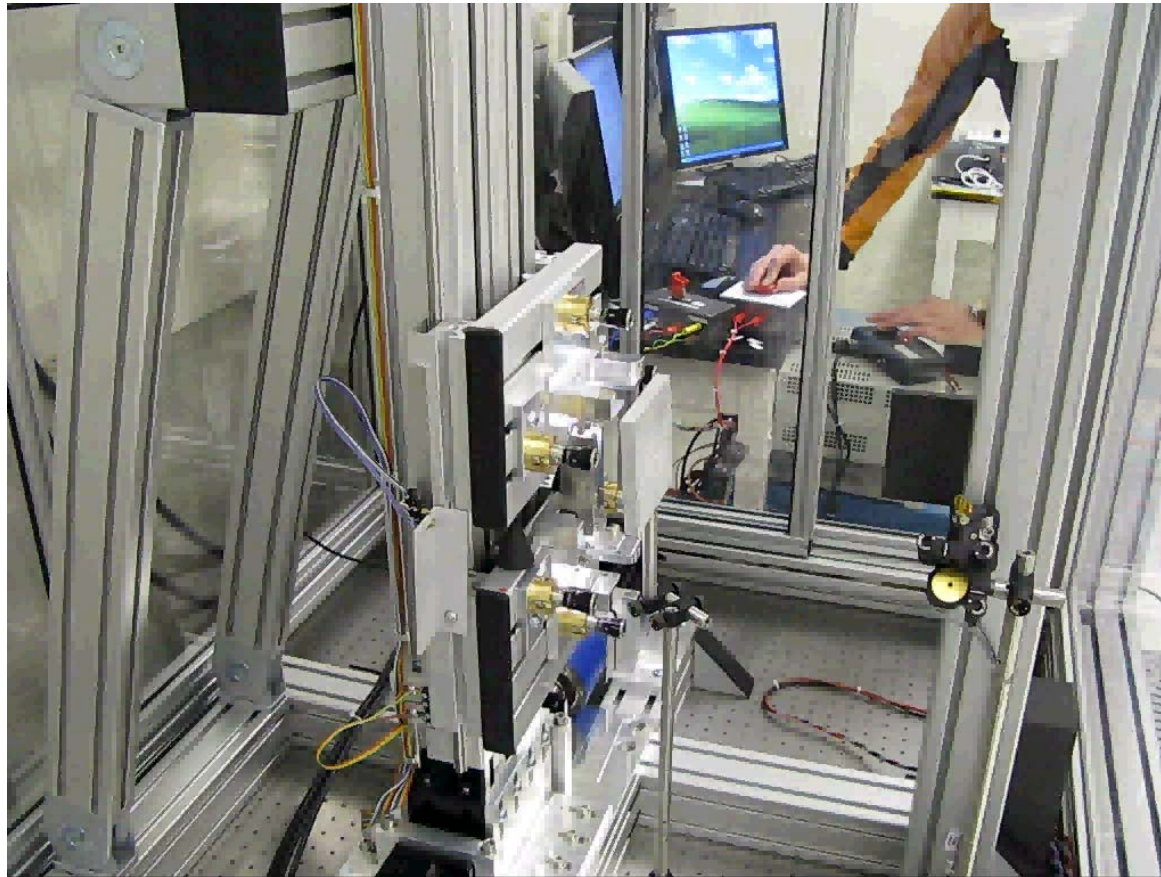

Heptonstall, Barton, Cagnoli, Cumming, Faller, Hammond, Hough, Jones, Kumar, Martin, Mittleman, Rowan, Strain, Tokmakov, van Veggel

LASTI Installation - Characterisation Equipment

- Parts have been delivered to LASTI for characterisation suite
 - Optical profiler
 - Bounce tester
 - Proof load
- Members of the University of Glasgow group have been installing these systems at the LASTI site
- Over the next month this work will be completed
- A destructive strength tester will also be installed in the coming weeks for further fibre evaluation

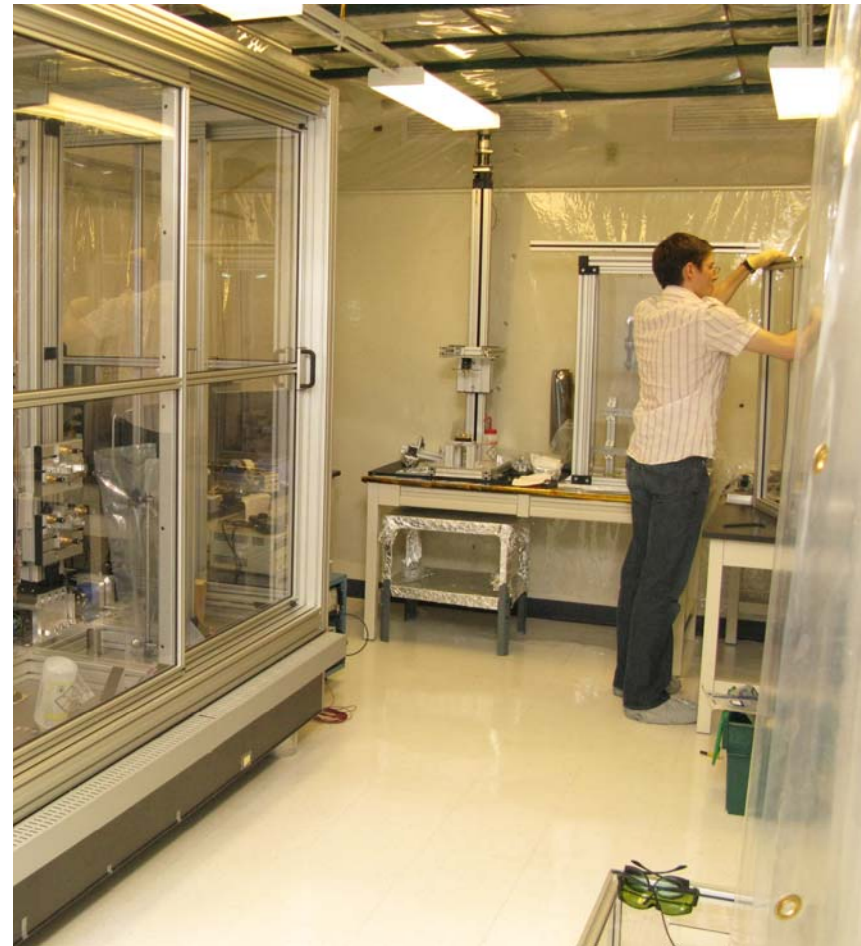

Heptonstall, Barton, Cagnoli, Cumming, Faller, Hammond, Hough, Jones, Kumar, Martin, Mittleman, Rowan, Strain, Tokmakov, van Veggel

Welding technology in Glasgow

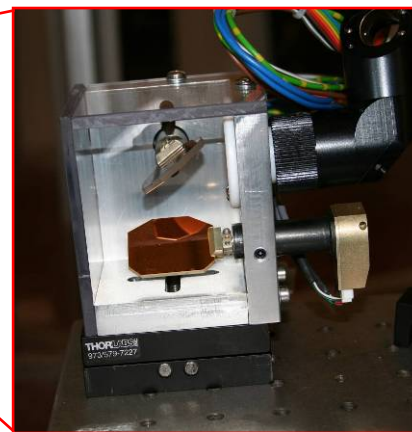
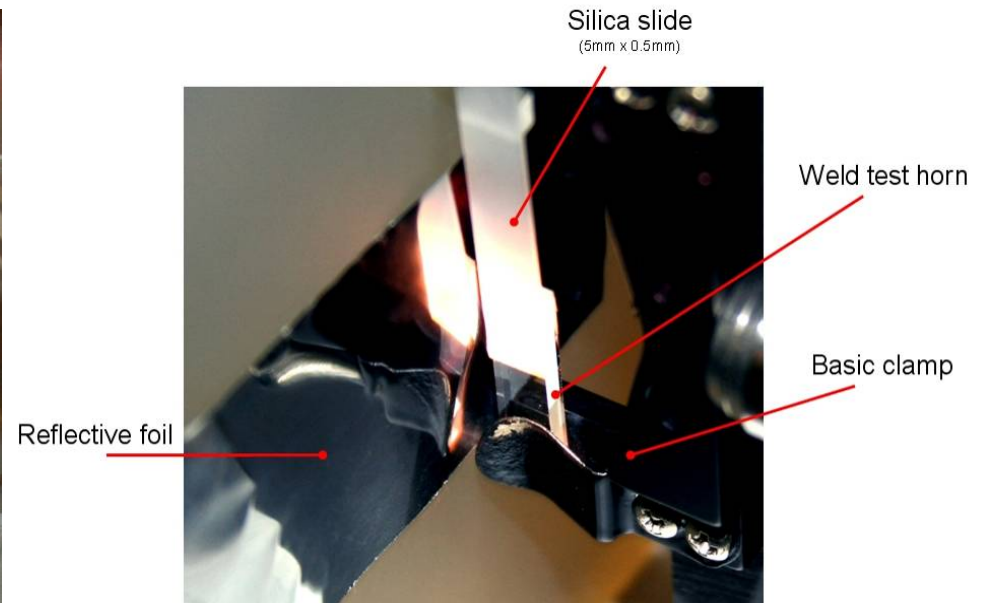

Heptonstall, Barton, Cagnoli, Cumming, Faller, Hammond, Hough, Jones, Kumar, Martin, Mittleman, Rowan, Strain, Tokmakov, van Veggel

Welding in and around the structure

Main structure



articulated arm
& injection optics

galvanometers

flats on mass
upper mass

outer structure
inner structure

lower mass

safety enclosure

truck bed

Flat on side of mass

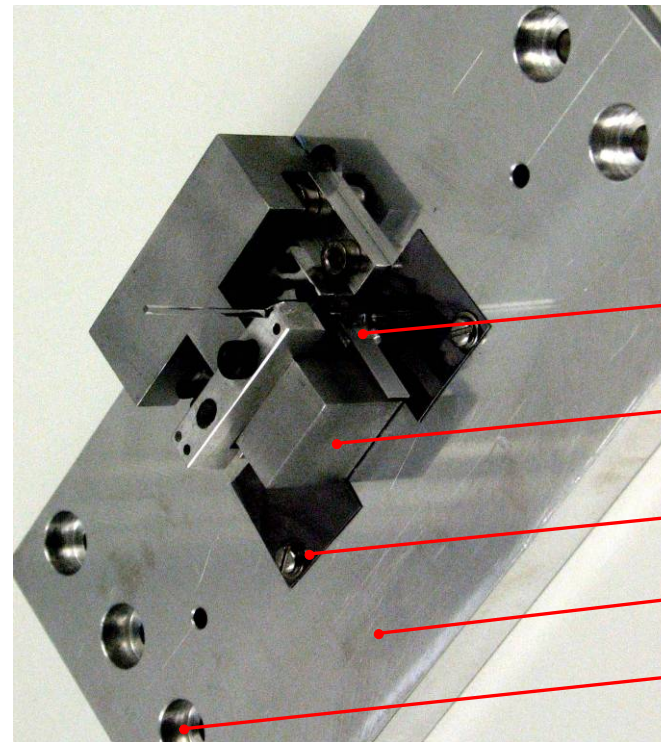

test ear

shot blasted
mount/baffle

tantalum
reflector

flat of mass

mounting holes

*Heptonstall, Barton, Cagnoli, Cumming, Faller, Hammond, Hough, Jones,
Kumar, Martin, Mittleman, Rowan, Strain, Tokmakov, van Veggel*

Initial Welding Tests at LASTI

- Mirror galvanometers have been set up on the optical bench, with a Labview control programme
- Preliminary tests on the bench are underway
- The articulated laser arm has been delivered to LASTI
- Designs for the tooling for welding in the structure have been completed
- This tooling is now out for manufacture

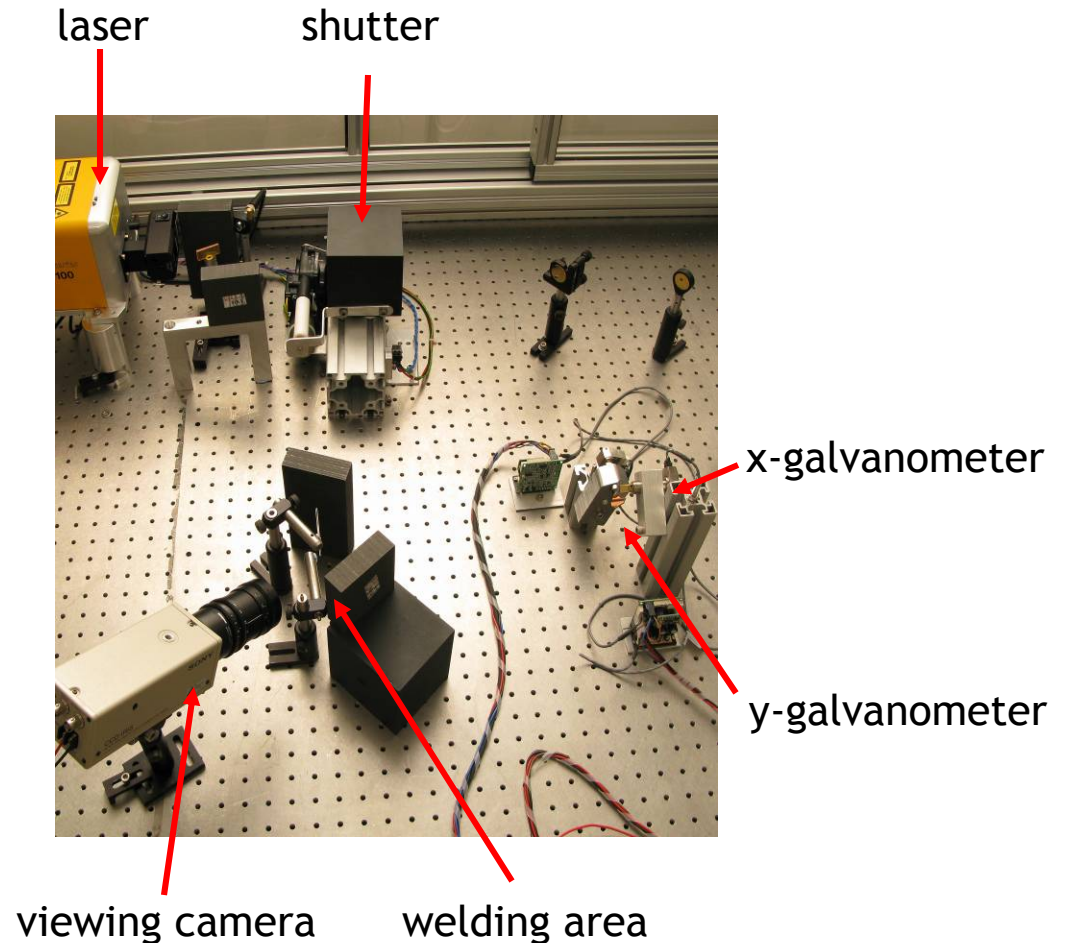

Heptonstall, Barton, Cagnoli, Cumming, Faller, Hammond, Hough, Jones, Kumar, Martin, Mittleman, Rowan, Strain, Tokmakov, van Veggel

Optimisation of Fibre Shape

- The current baseline uses a 'thin ribbon' design (60cm x 1.15mm x 0.115mm)
- This design maximises dilution by minimising stiffness in direction of measurement
- At 20Hz loss is a factor of 6 lower compared to a similar cross section cylindrical
- The plot below show the main sources of loss for a baseline design ribbon
- The dominant source of dissipation is non-linear thermoelastic loss

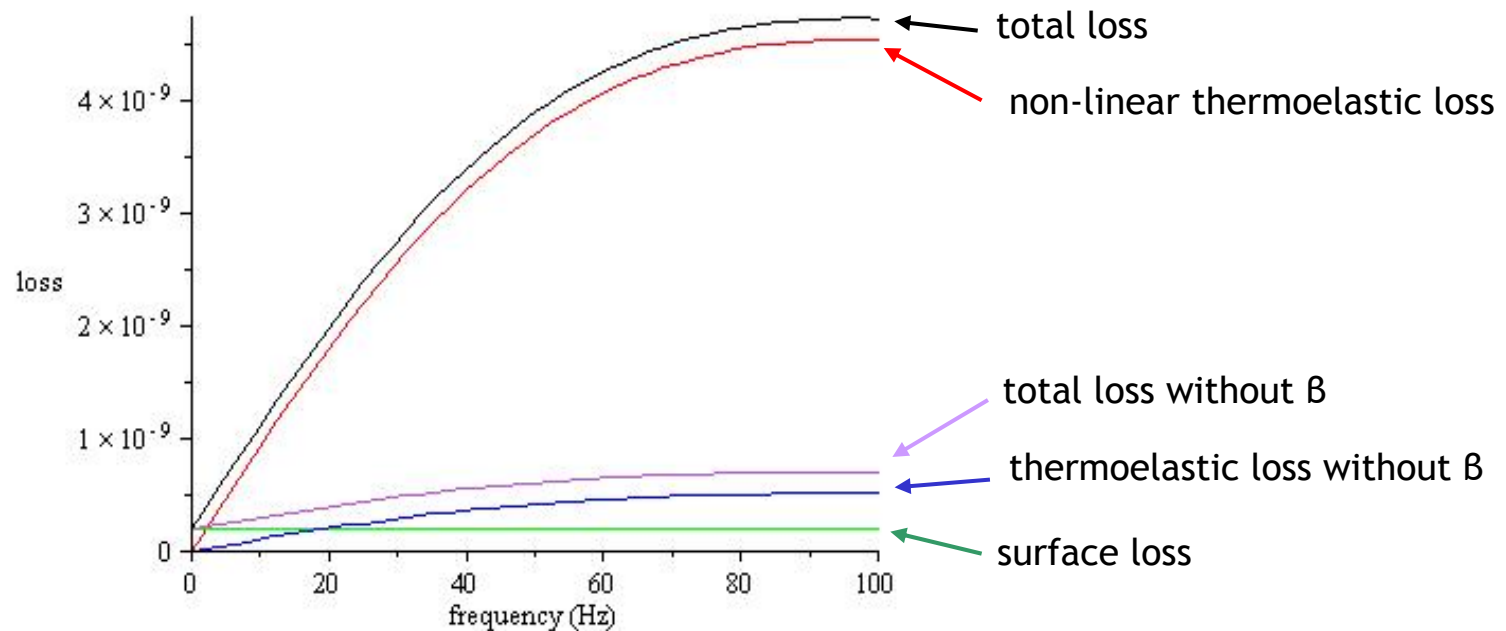

Heptonstall, Barton, Cagnoli, Cumming, Faller, Hammond, Hough, Jones, Kumar, Martin, Mittleman, Rowan, Strain, Tokmakov, van Veggel

Optimisation of Fibre Shape

- Obtaining a high dissipation dilution is not the only critical factor in reducing loss
- We present here initial results of modeling of different suspension fibre geometries to look for optimised shapes for the Advanced LIGO suspensions
- A two stage analytical/FEA computer model is used to look at optimising fibre shape
- We have used a ribbon aspect ratio of 10:1 here
- Included are the effects of surface dissipation, dissipation dilution, non-linear thermoelastic loss and energy distribution in the suspension

$$\phi_{total} = \sqrt{\frac{YI}{Tl^2}} \left[\underbrace{\frac{E_{surface}}{E_{bulk}} \phi_{surface}}_{\text{dilution}} + \underbrace{\left(\frac{YT}{\rho C} \right) \left(\frac{\omega\tau}{1 + (\omega\tau)^2} \right)}_{\text{surface loss}} \underbrace{\left(\alpha - \beta \frac{\sigma_0}{Y} \right)^2}_{\text{non-linear thermoelastic loss}} \right]$$

Heptonstall, Barton, Cagnoli, Cumming, Faller, Hammond, Hough, Jones, Kumar, Martin, Mittleman, Rowan, Strain, Tokmakov, van Veggel

Optimisation of Fibre Shape

- Plotted below is total loss as a function of fibre thickness
- A substantial improvement can be made across a wide frequency range by moving to fibres with thicker flexure regions
- Thicker flexure regions have a reduced stress, and hence a reduced thermoelastic loss

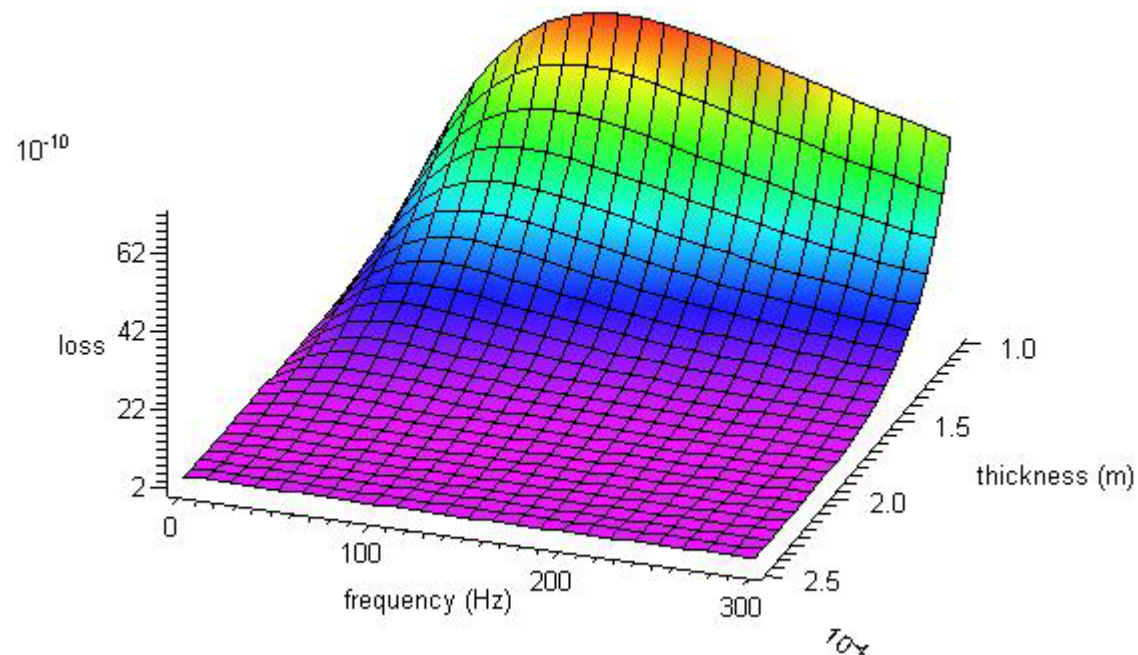

Heptonstall, Barton, Cagnoli, Cumming, Faller, Hammond, Hough, Jones, Kumar, Martin, Mittleman, Rowan, Strain, Tokmakov, van Veggel

Optimisation of Fibre Shape

- Below we plot the loss at 20Hz for a ribbon fibre
- The optimum thickness for the flexure region is 0.221mm
- The total loss for this thickness is 3.76×10^{-10}
- This is an improvement of a factor of 5 compared to the baseline design

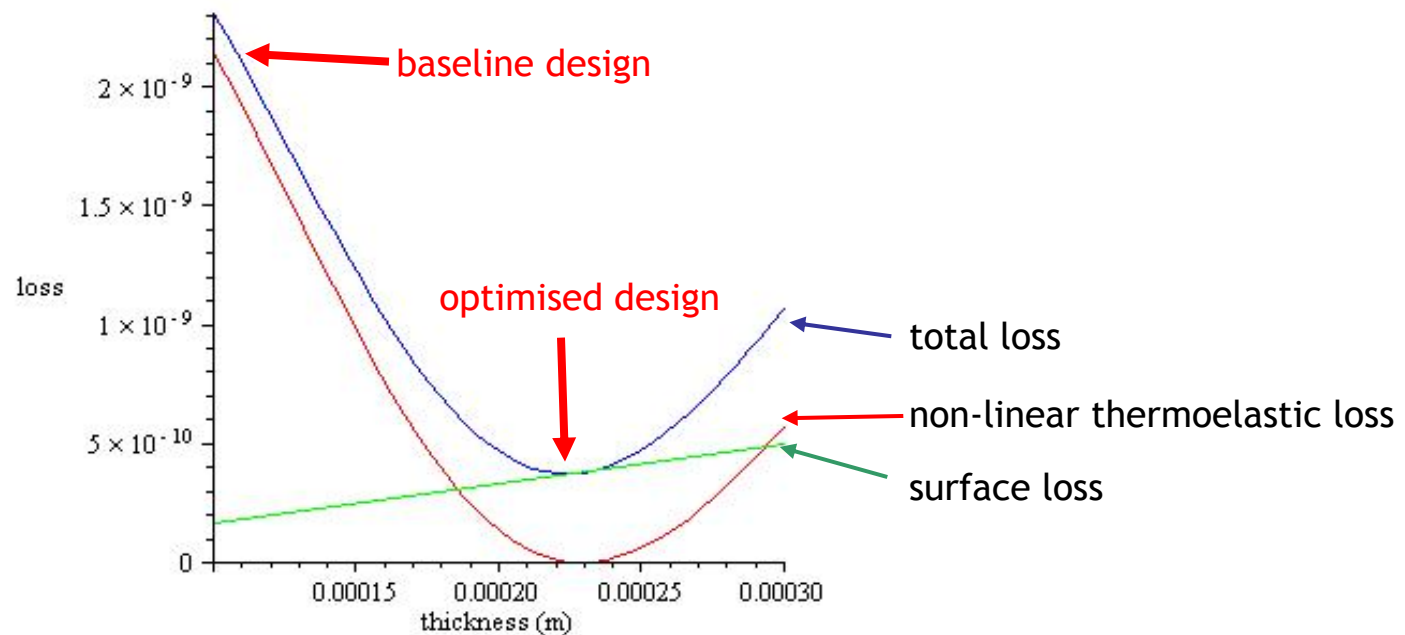

Heptonstall, Barton, Cagnoli, Cumming, Faller, Hammond, Hough, Jones, Kumar, Martin, Mittleman, Rowan, Strain, Tokmakov, van Veggel

Optimisation of Fibre Shape

- This optimisation model was repeated for cylindrical fibres.
- Again a significant improvement in performance is possible by moving to thicker flexure regions

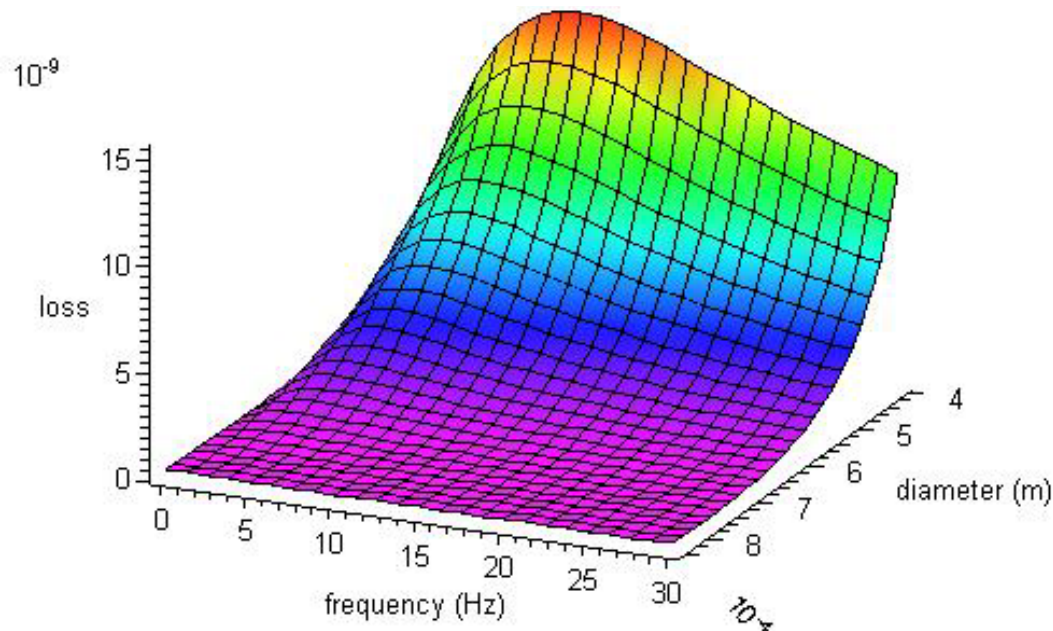

Heptonstall, Barton, Cagnoli, Cumming, Faller, Hammond, Hough, Jones, Kumar, Martin, Mittleman, Rowan, Strain, Tokmakov, van Veggel

Optimisation of Fibre Shape

- At 20Hz the optimum diameter for cylindrical fibres is 794 μ m.
- The total loss for this thickness is 4.25×10^{-10}
- The vertical stiffness of the fibre can be brought down by reducing the diameter of the central section by 8 μ m.

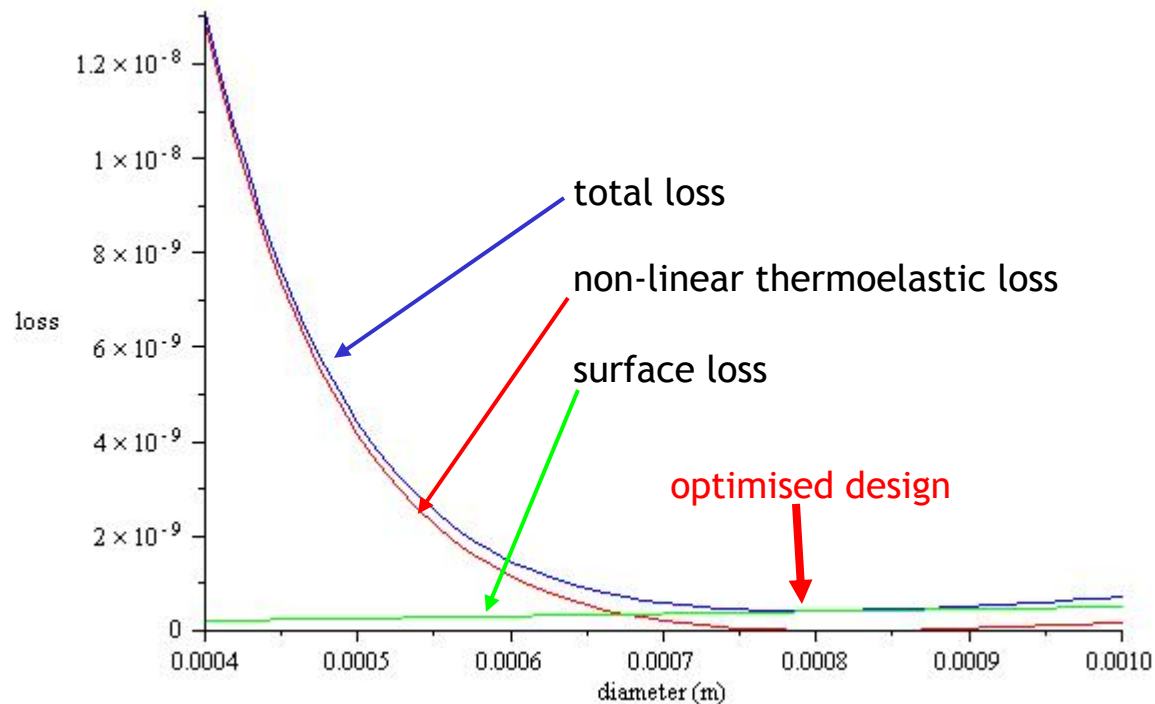

Heptonstall, Barton, Cagnoli, Cumming, Faller, Hammond, Hough, Jones, Kumar, Martin, Mittleman, Rowan, Strain, Tokmakov, van Veggel

Comparison of Fibre Designs

- The plot below shows a comparison between cylindrical and ribbon fibres
- In optimum configuration there is 15% difference between ribbon and cylindrical fibre performance
- Both give significant decrease in loss compared to the baseline ribbon design
- The optimised fibre performance has a lower frequency dependence

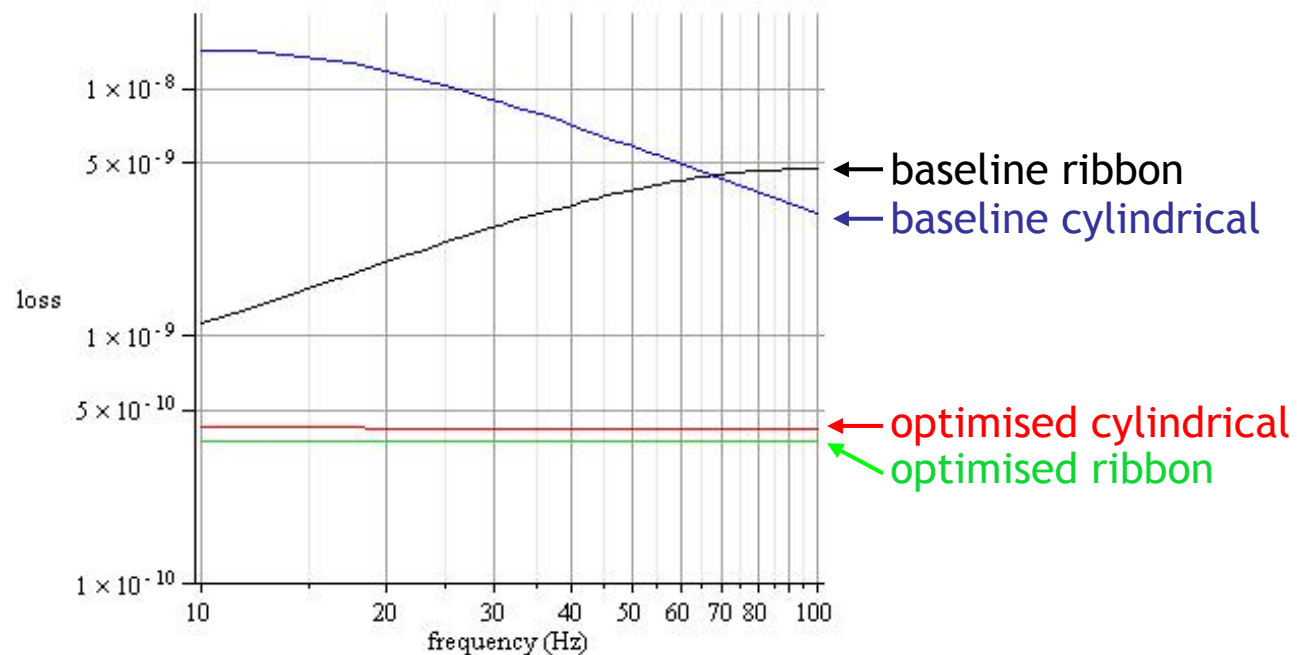

Heptonstall, Barton, Cagnoli, Cumming, Faller, Hammond, Hough, Jones, Kumar, Martin, Mittleman, Rowan, Strain, Tokmakov, van Veggel

FEA Modelling of Optimised Fibre

- An Ansys model was made for an optimised fibre design.
- The fibre has 1cm long thicker ends, with a short taper down to the thinner central section
- Dilution found using FEA matches theoretical to within 3%

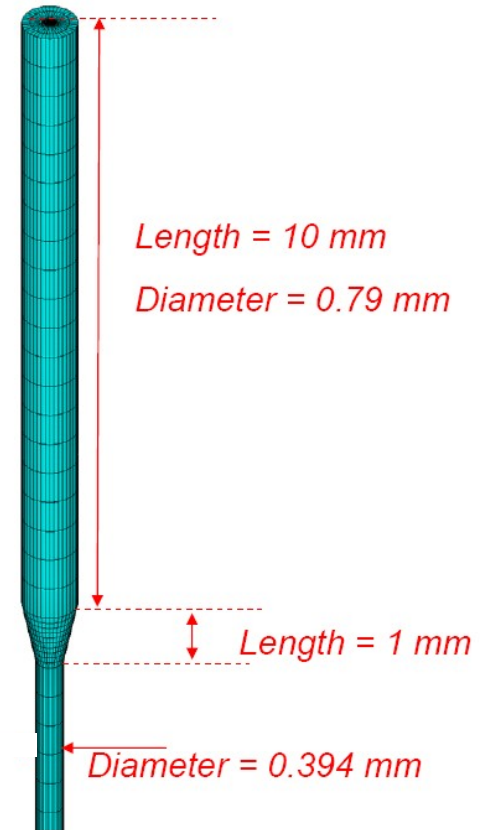
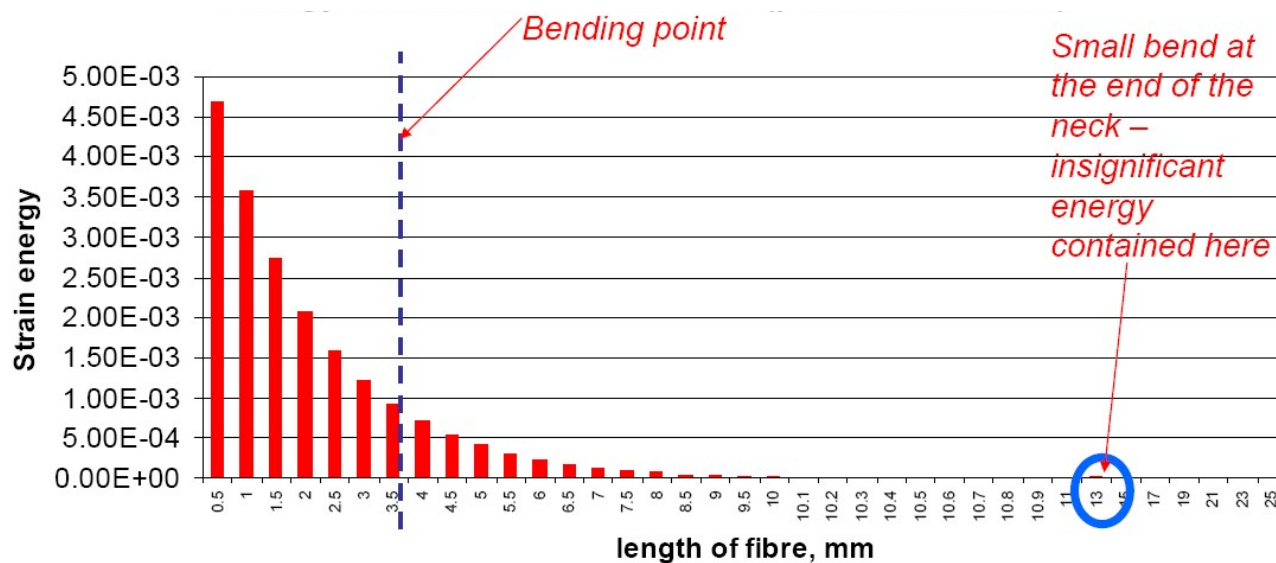

Heptonstall, Barton, Cagnoli, Cumming, Faller, Hammond, Hough, Jones, Kumar, Martin, Mittleman, Rowan, Strain, Tokmakov, van Veggel

FEA Modelling of Ear Stiffness

- A further model was constructed to add in the effects of ears
- Since a real ear cannot be infinitely stiff some small amount of flexing must occur
- Using FEA we can quantify the amount of energy stored in the ear and tapered fibre end

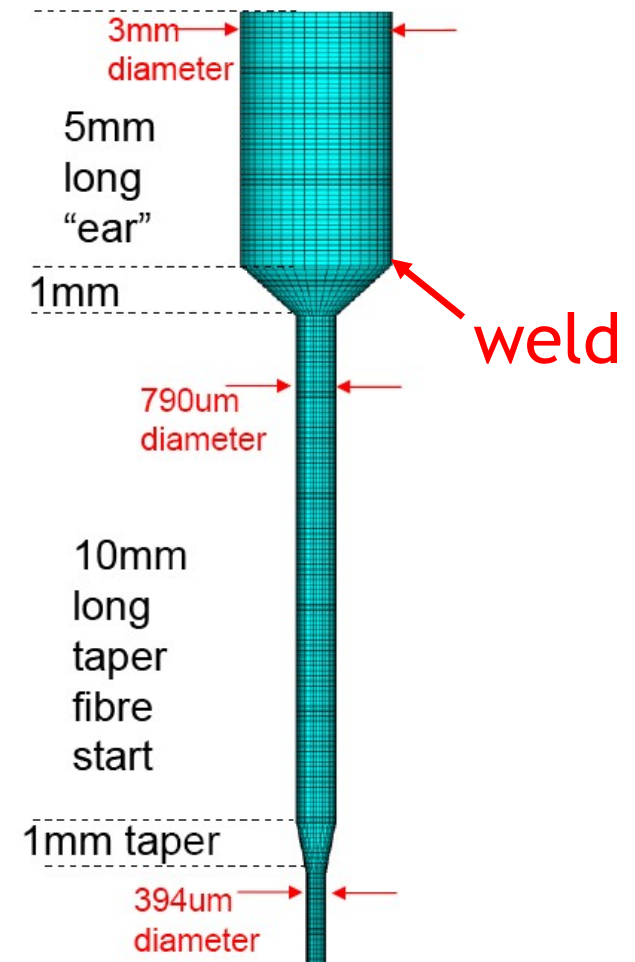
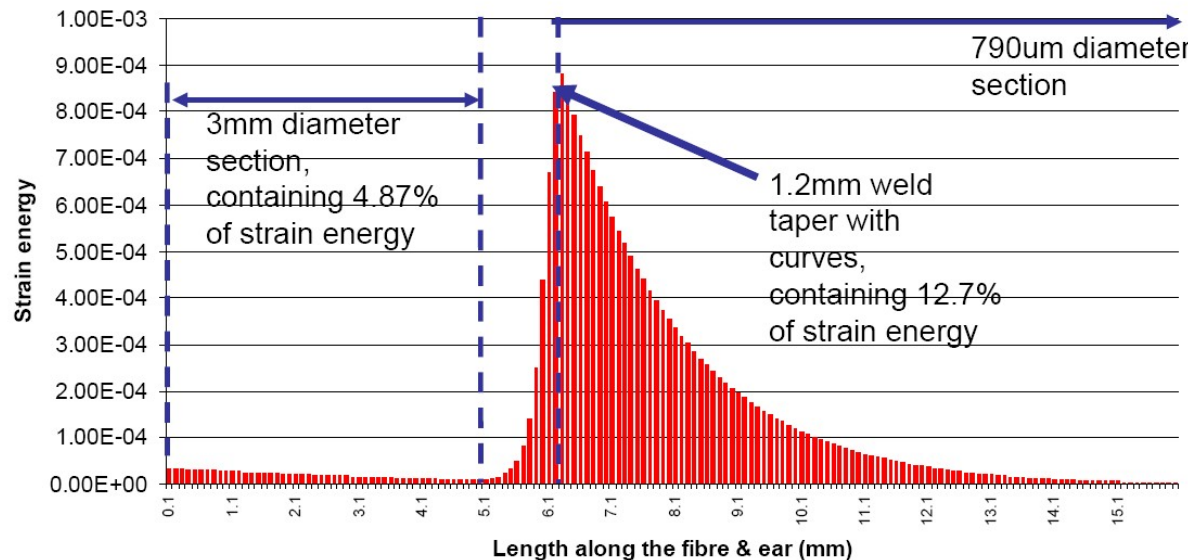

Heptonstall, Barton, Cagnoli, Cumming, Faller, Hammond, Hough, Jones, Kumar, Martin, Mittleman, Rowan, Strain, Tokmakov, van Veggel

FEA Modelling of Ear Stiffness

- Using the energy ratios found from FEA it is then possible to calculate the loss contributions from each section of the fibre and ear assembly

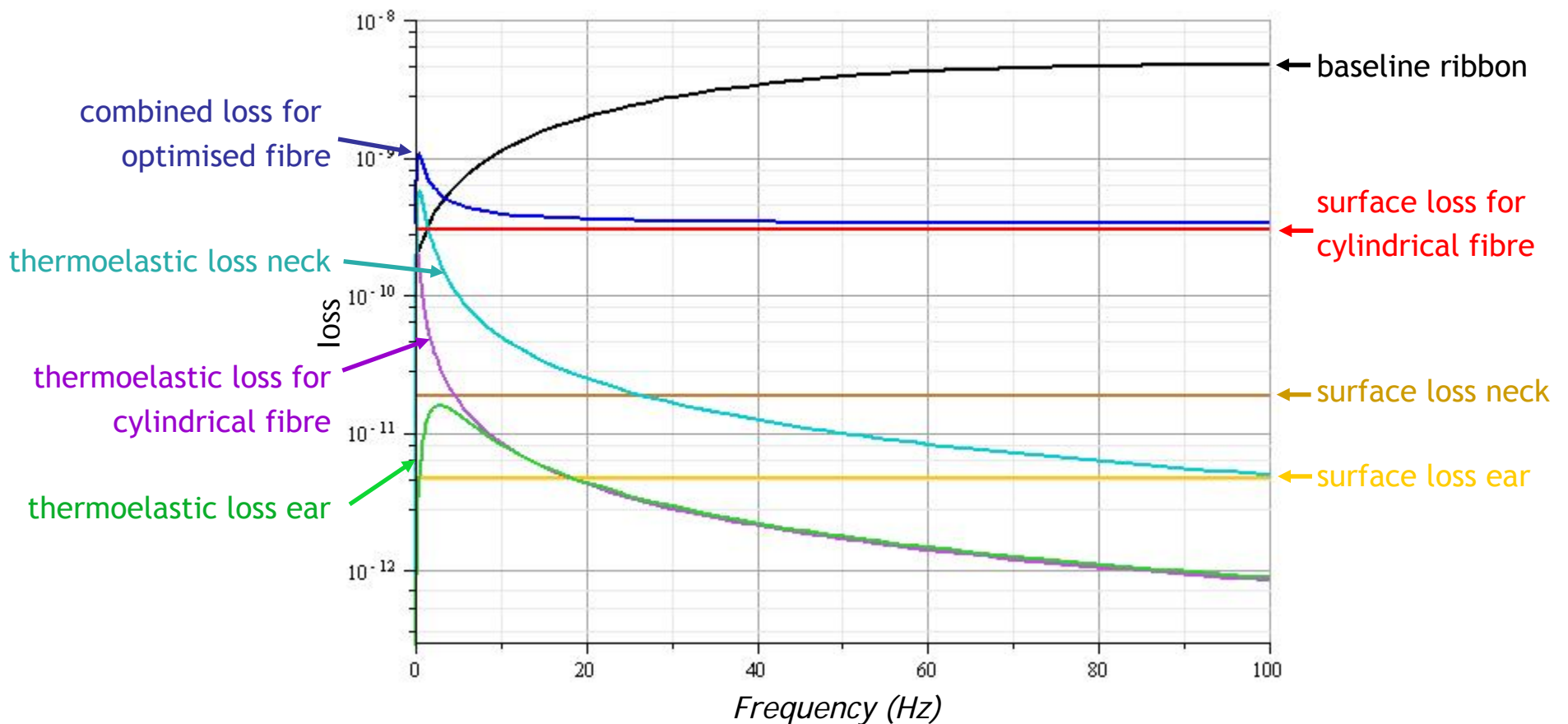

Heptonstall, Barton, Cagnoli, Cumming, Faller, Hammond, Hough, Jones, Kumar, Martin, Mittleman, Rowan, Strain, Tokmakov, van Veggel

Conclusions

- Optimising of the thickness of the fibre ends can result in reduced loss compared to the baseline design
- There is a 15% difference between the optimised cylindrical and optimised ribbon fibres
- Cylindrical fibres have been proven in use in GEO600 suspensions, with a large quantity of literature relating to them
- They are simple to produce and tapered versions have already been demonstrated using the LASTI pulling machine
- We would suggest that use of the optimised cylindrical fibre design presented here is advantageous compared to the current baseline ribbon design in terms of superior performance and reduced risk

Heptonstall, Barton, Cagnoli, Cumming, Faller, Hammond, Hough, Jones, Kumar, Martin, Mittleman, Rowan, Strain, Tokmakov, van Veggel