The Detection of Gravitational Waves

Barry Barish
Caltech

Harvey Mudd College
March 5, 1996

Gravitational vs E.M. Waves

	EM WAVES	GRAV. WAVES
Nature	Oscillation of EM Fields Propagating Through Spacetime	Oscillations of the "fabric" of spacetime
Emission Mechanism	Incoherent superposition of waves from molecules, atoms, particles	Coherent emission by bulk motion of energy
Interaction with Matter	Strong absorption and Scattering	Essentially None!
Frequency Band	$f > 10^7 \text{Hz}$	$f < 10^4 \text{Hz}$

■ Implications

- ◆ Most gravitational sources not seen as electromagnetic (and vice versa)
- ◆ Potential for great surprises
- ◆ Uncertainty in strengths of waves

Gravitational Wave Emission

Russell Hulse and Joseph Taylor

PSR 1913 + 16

17/sec

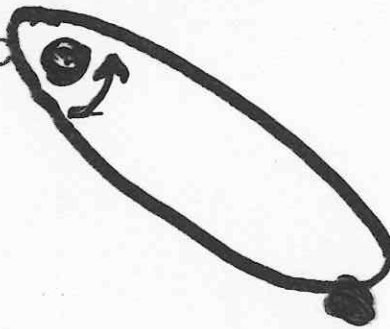

Timing of Pulsars

8 hr

Timed to $\sim 50 \mu\text{sec}$

Since discovery, observed period
gradually speed up

- 10 sec in 15 years
- growing quadratically in time

Due to loss of orbital energy, from
emission of gravitational waves

Neutron Star Binary Coalescence

<i>Method</i>	<i>Our Galaxy</i>	<i>Distance for 3/yr</i>
Progenitor Death Rate	$\sim 1/1000$ yr	130 M.L.yr
Binary Pulsar Searches and Discoveries	$\sim 1/10^{5\pm 1}$ yr	600 M.L.yr.
Ultra-conservative Limit from Binary Pulsar Searches	$\sim 1/10^7$ yr	3000 M.L.yr

International Effort - Gravitational Waves

□ Techniques

⇒ Resonant Bar Detectors

- narrow band

⇒ Large Scale Interferometers

- broad band

□ International Interferometer Effort

⇒ U.S. -- LIGO (Two Sites)

- Caltech & MIT (Wash and Louisiana)

⇒ Europe -- VIRGO (One Site)

- French and Italian (near Pisa)

⇒ Smaller efforts

- Germany, Japan, Australia

□ Time Scale

⇒ Approximately year 2000

LIGO

Scientific Mission

□ Direct Detection of Gravitational Waves

Neutron Binary Coalescence
(Last 15 minutes of Hulse/Taylor
in 100 Million Years)

- ⇒ Test General Relativity in Strong Field and High Velocity Limit
- ⇒ Measure Polarization and Propagation Speed

WAVEFORMS FROM BINARY INSPIRAL

(Very "clean"; depend only on $M_1, M_2, \vec{S}_1, \vec{S}_2, r$, orbital elements)

WAVEFORM

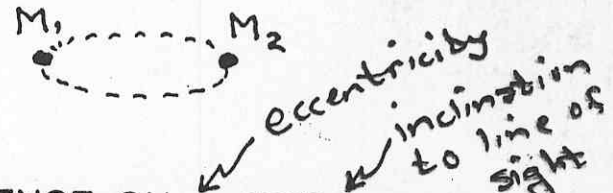
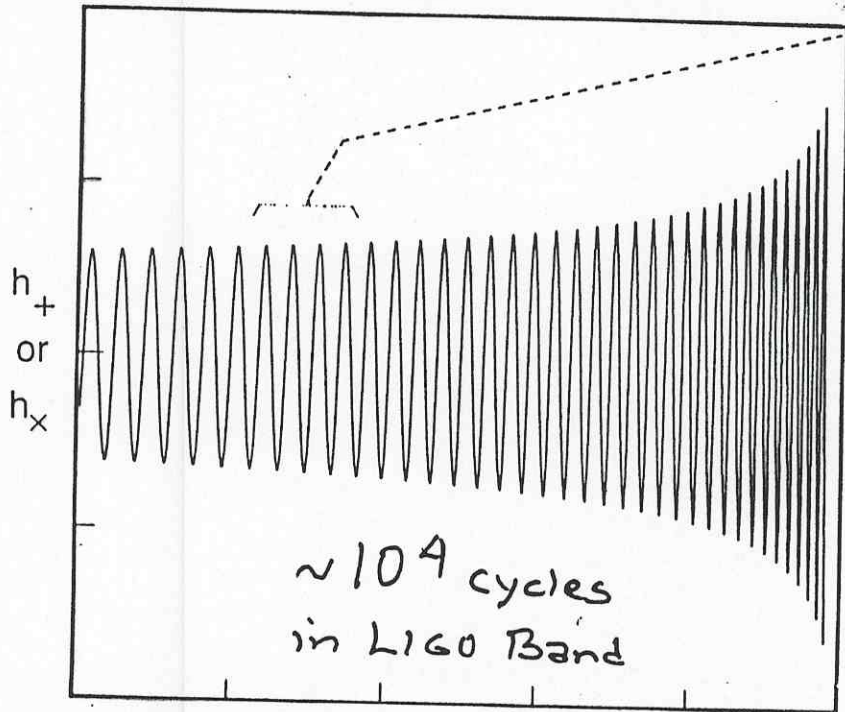

DEPENDENCE ON e , FOR $i = 90^\circ$
(expect $e = 0$)

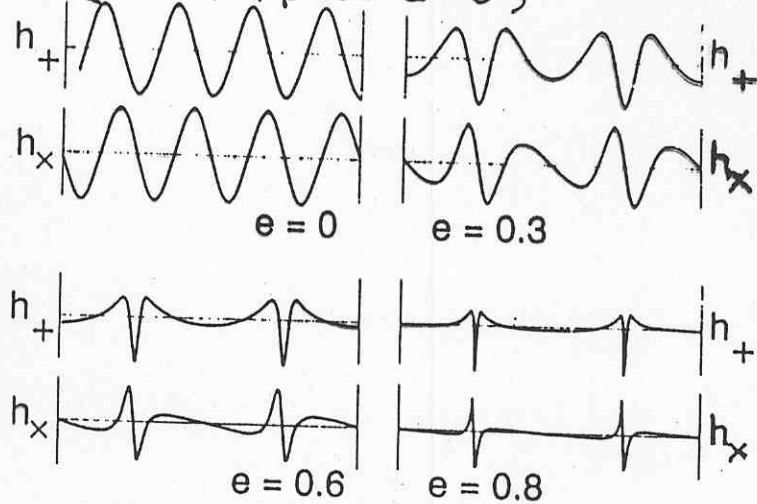

DEPENDENCE ON i , FOR $e = 0$:

$$\frac{\text{Amp}(h_x)}{\text{Amp}(h_+)} = \frac{2 \cos i}{1 + \cos^2 i}$$

FOR $e = 0$

$$\frac{df}{dt} \propto \frac{M_1 M_2}{(M_1 + M_2)^{1/3}} f^{11/3} + \left(\text{relativistic corrections that depend on } M_1, M_2, \vec{S}_1, \vec{S}_2 \right)$$

$$\text{Amplitude} \propto \frac{M_1 M_2}{(M_1 + M_2)^{1/3}} \frac{r}{f^{2/3}}$$

Masses & Spins
 $\Delta M/M \sim \text{few } \%$

Distance
 $\Delta r/r \sim .05 \text{ to } .5$ STANDARD CANDLE!

"Chirp Mass"
 $\Delta M/M \sim 0.001$

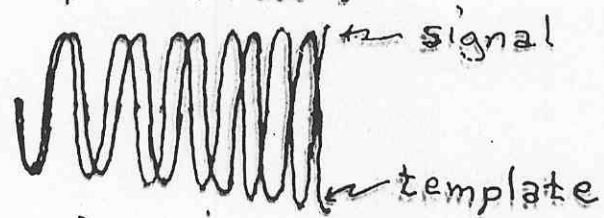

↑ Sensitivity to phase evolution: $\sim 1/10^5$

LIGO Long Range Goals

□ “New Tool” to Explore the Universe

⇒ Final Coalescence of Binary Systems

- Neutron Star/Neutron Star

Design Benchmark: last 15 min;
20,000 cycles
600MLyr

- Black-hole/Black-hole or /Neutron Star

⇒ Supernovae

- Axisymmetric in our galaxy
- Non-axisymmetric ~300MLyr

⇒ Early Universe

- Vibrating Cosmic Strings
- Vacuum Phase Transitions
- Vacuum Fluctuations from Planck Era

⇒ The Unknown

Gravitational Wave Strength

Strain Sensitivity

$$h \approx \frac{G(E_{kin}^{ns} / c^2)}{r} \frac{1}{c^2}$$

for $E_{kin}^{ns} / c^2 \sim M_{\odot}$

$h \sim 10^{-20}$ for Virgo Cluster of Galaxies

$h \sim 10^{-23}$ at Hubble Distance

LIGO Goal: $h \sim 10^{-22}$

Detector $\Delta L = hL$

$L = 4km \Rightarrow \Delta L = 10^{-16} cm$

This leads to Stringent Specifications:

Vacuum

Seismic and Acoustic Isolation

Test Mass Suspensions

Optics

etc.

SCHEMATIC INTERFEROMETRIC DETECTOR

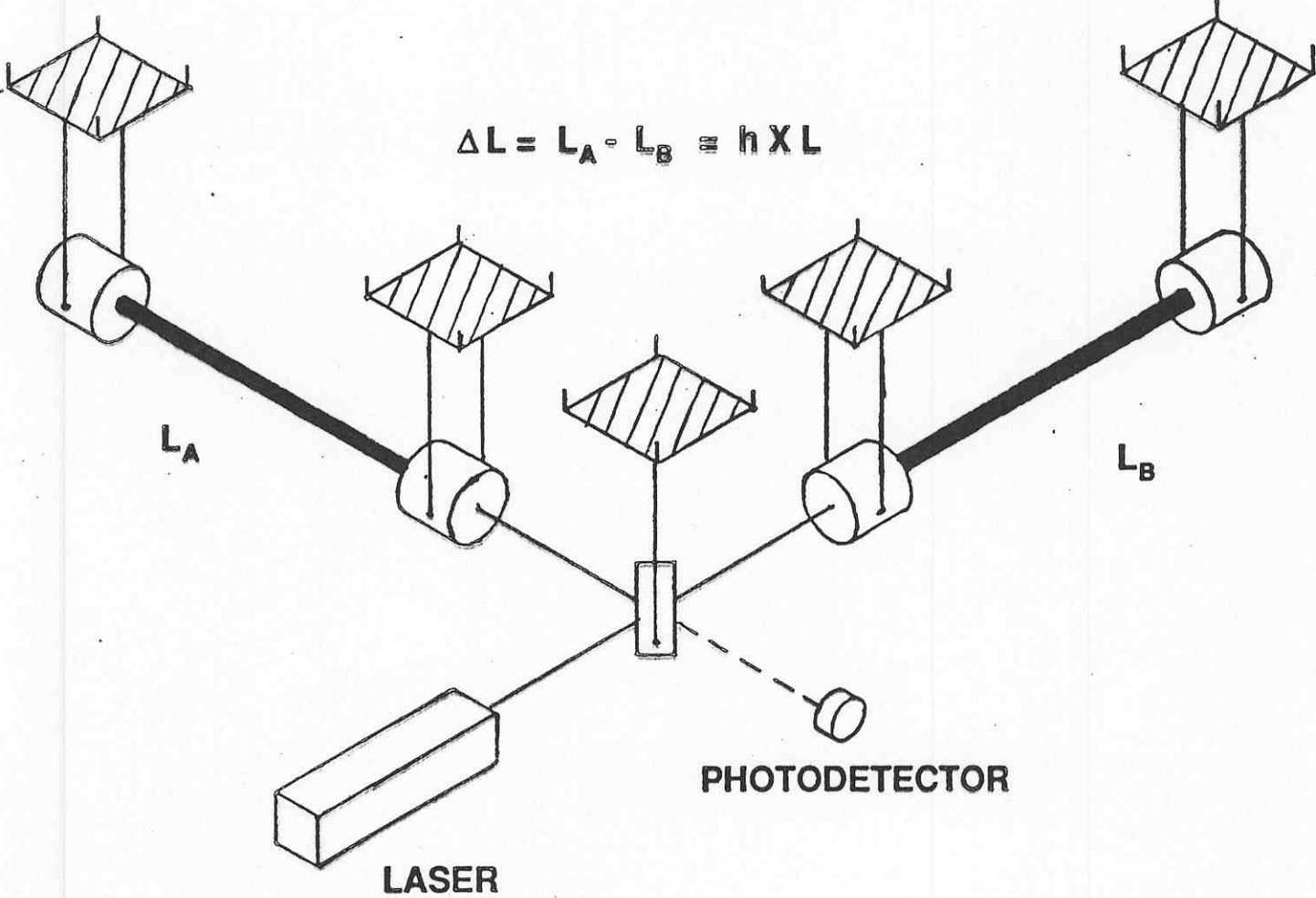

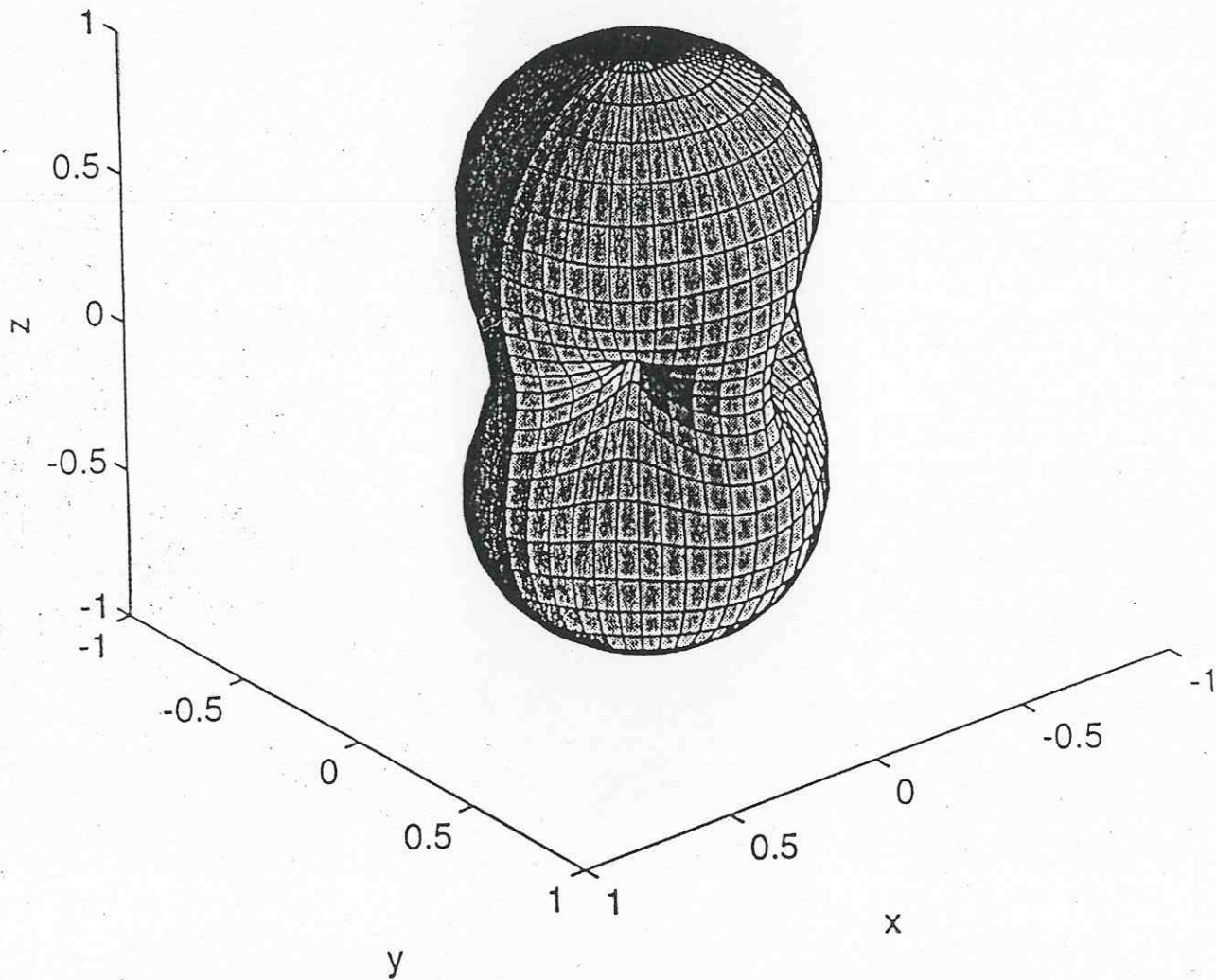
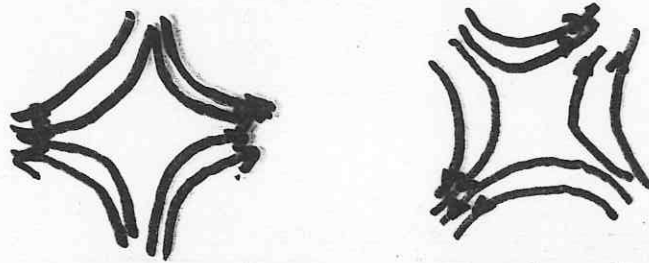

Figure 2.7 The sensitivity, as a function of direction, of an interferometric gravitational wave detector to unpolarized gravitational waves. The interferometer arms are oriented along the x and y axes.

Forces Exerted by a Gravitational Wave

If Detector Size \ll Wavelength
(4 km) (300-30,000km)

Then: Quadrupolar Lines of Force



+ Polarization x Polarization

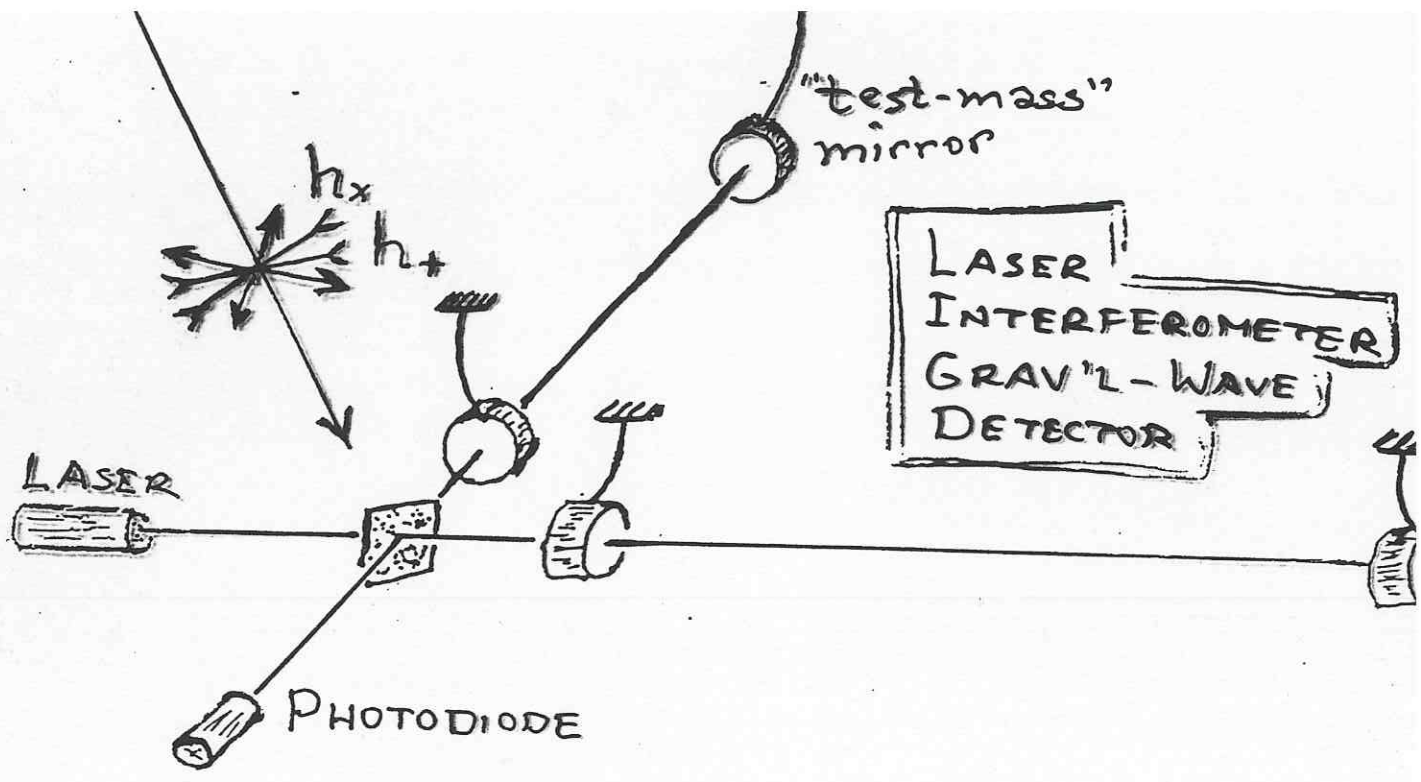

$$\frac{\Delta L}{L} \equiv h = F_+(direction) h_+(t) + F_x(direction) h_x(t)$$

Antenna Patterns \swarrow
 \nwarrow Waveforms \searrow

- LIGO measures one waveform;
 - \uparrow Hanford WA
 - Livingston LA

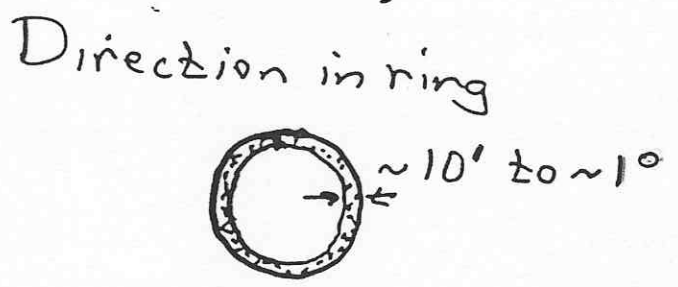

- LIGO + VIRGO measure both waveforms;
 - \uparrow Pisa Italy

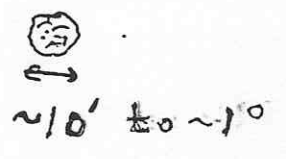

NEUTRON STAR BINARIES

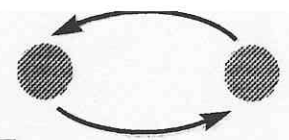

[“Near-Guaranteed” source]

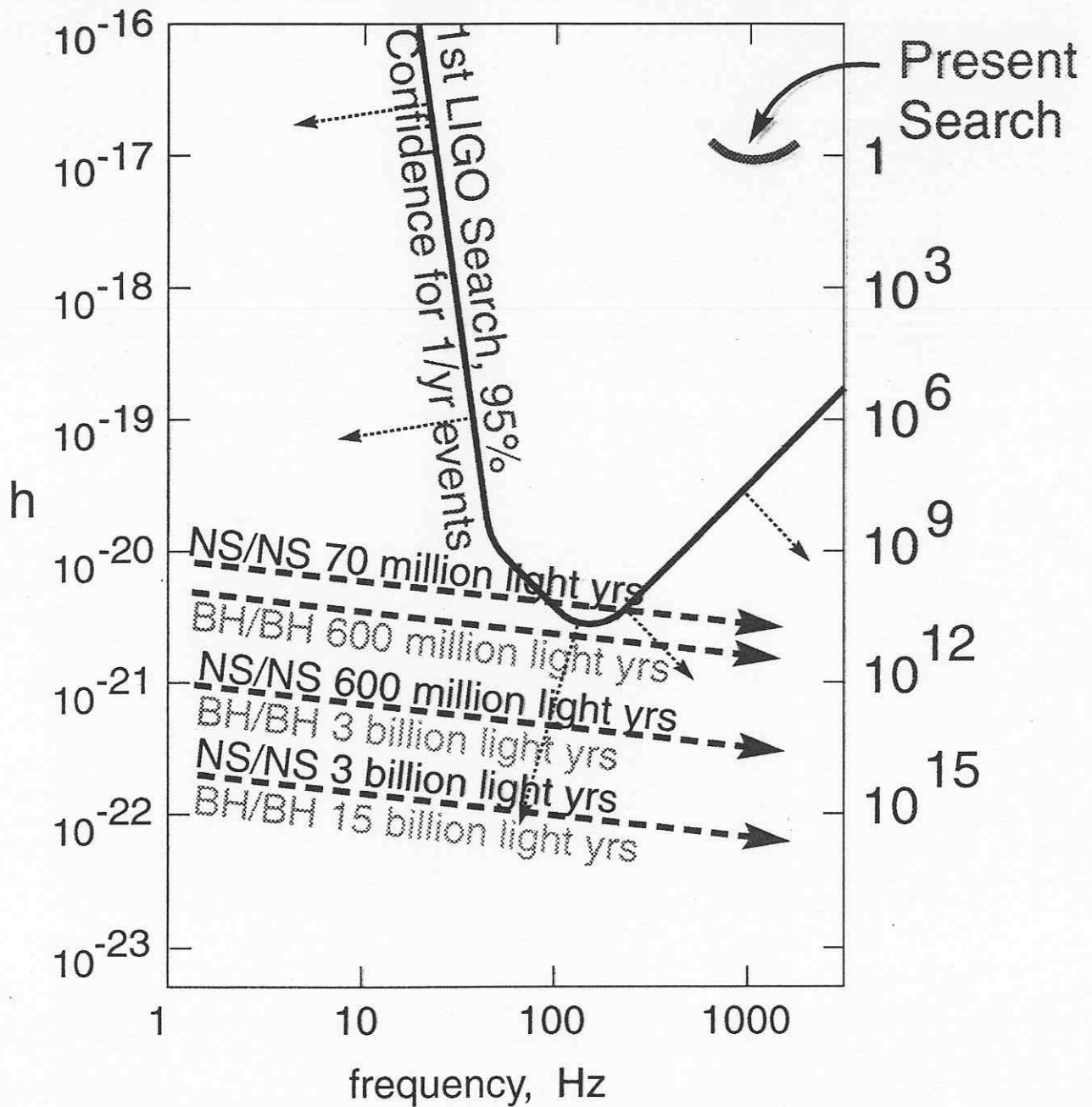

■ 15 minutes & 10,000 orbits in LIGO band

■ Rich information in waveforms:

masses, spins, distance, direction,
nuclear equation of state

LIGO

- National Science Foundation
- Construction Project (1994-1999)
 - ⇒ Facilities and Initial Detector
- Commission Facility (1999-2001)
 - ⇒ Implement Initial Detectors
 - $h \sim 10^{-20}$ - Initial Search in 2000
 - $h \sim 10^{-21}$ - Sensitivity by end 2001
- Full Operations (2002 + ...)
 - ⇒ Operate/Enhance Initial Detector
 - data collaboration with VIRGO
 - incorporate outside Users
 - ⇒ Advanced Detectors
 - Syracuse, Colorado, Stanford, etc
 - Caltech efforts (LIGO, Drever, Kimble..)

LIGO Project

- **Detector**
 - » Detection Strategy
 - » Interferometers

- **R&D**
 - » Noise Sources and Sensitivity
 - » Demonstration Experiments

- **Major Facilities**
 - » Beam Tube
 - » Vacuum Systems
 - » Civil Construction

- **Status and Plans**

Gravitational Wave Detection Strategy

□ Interferometer Sensitivity

⇒ R&D Program

- Technology Development
- Demonstration Experiments

⇒ Engineering Implementation

- Precision Engineering Design
- Quality Control

□ Two Sites - Three Interferometers

⇒ Single Interferometer ~50/hr

- non-gaussian level

⇒ Hanford (Doubles) ~1/day

- correlated rate (x1000)

⇒ Hanford + Livingston <0.1/yr

- uncorrelated (x5000)

MULTIPLE COINCIDENCES

local window 1msec
non-local window 20msec

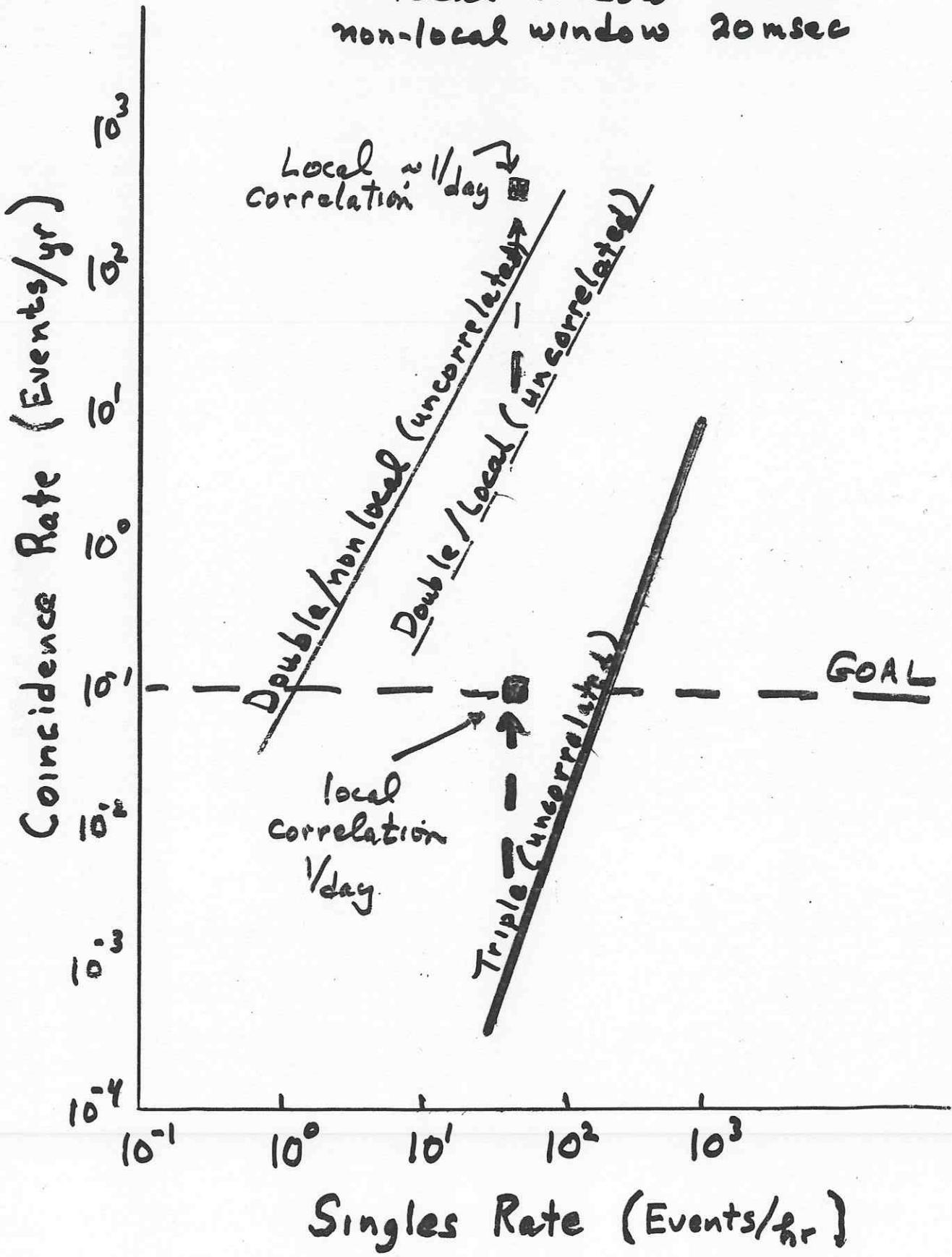

Description of LIGO

- Two Sites - Widely Separated
- Hanford, Washington
 - 4km and 2km Interferometers
- Livingston, Louisiana
 - 4 km Interferometer
- Expansion for Advanced Detectors

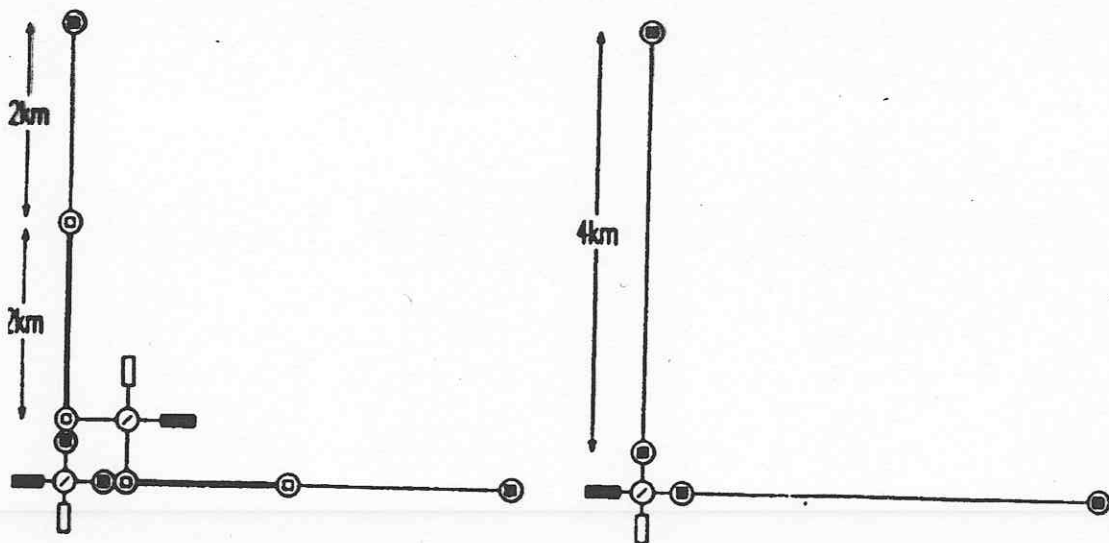

LIGO Site Pair

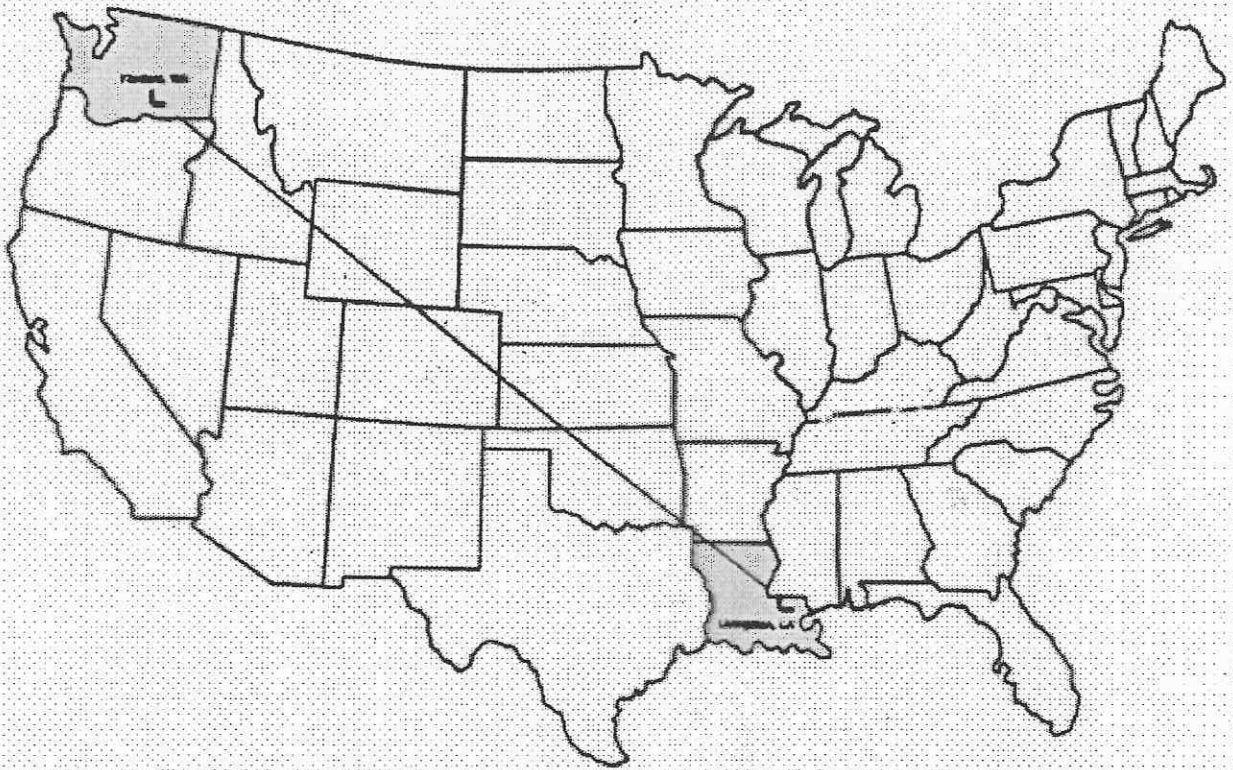

- **Hanford, Washington**
 - Located on U.S. Dept. of Energy Reservation
 - Treeless, Semi-arid Desert
 - Approx. 25 km from Richland (Metropolitan Pop. 140,000)
- **Livingston, Louisiana**
 - Located in Forested Rural Area
 - Approx. 50 km from Baton Rouge (Pop. 450,000)

Detectors

□ Approach and Characteristics

⇒ Employ Demonstrated Techniques

- Required R&D has been defined
- 40m, 5m, Optics Experiments, etc

⇒ Precision Engineering

- Design Freeze (1997)

⇒ Systems Engineering/Integration

- Interfaces, flexibility

⇒ Advanced Control/Data System

□ Status and Plans

⇒ Design/Performance for Detector is Consistent with the Design Goals

- Optimization of the Design
- Define Responsibilities
- Advanced Options: seismic isolation, suspension, laser ???

Noise Budget For First LIGO Detectors

- 5 Watt Laser
- Mirror Losses 50 ppm
- Recycling Factor of 30
- 10 kg Test Masses
- Suspension $Q=10^7$

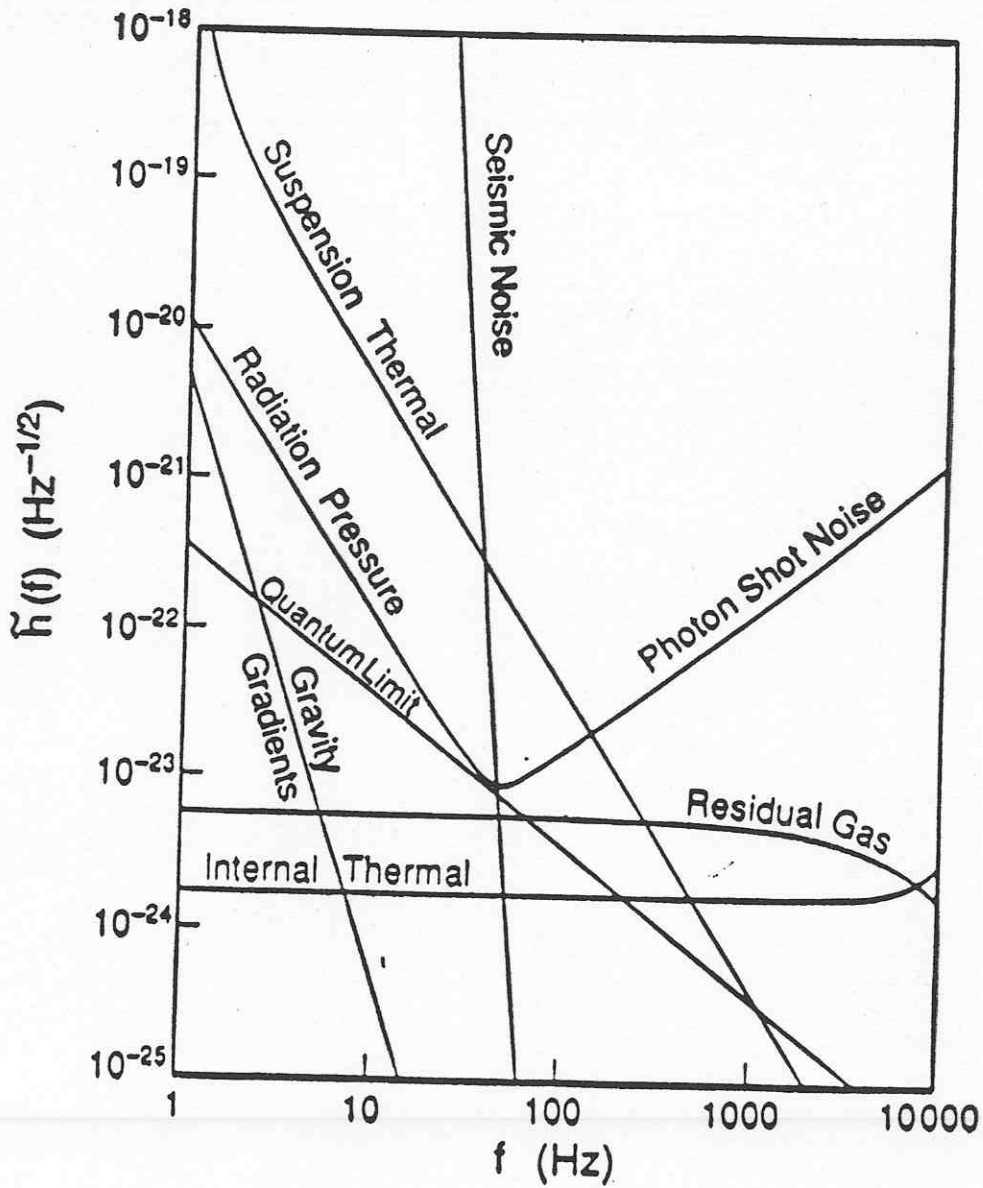

Table 1-1. Initial interferometer specifications

Strain Sensitivity	10^{-21}
Displacement Sensitivity	$4 \times 10^{-18} \text{ m}$
Fabry-Perot Arm Length	4000 <i>m</i>
Vacuum Level	$< 10^{-6} \text{ torr}$
Laser Wavelength	514.5 <i>nm</i>
Optical Power at Laser Output	5 <i>W</i>
Optical Power at Interferometer Input	2 <i>W</i>
Power Recycling Factor	30
Input Mirror Properties	Flat, Reflectivity = 0.97
End Mirror Properties	6-km Curvature, Reflectivity > 0.9999
Arm Cavity Optical Loss	$\leq 3\%$
Light Storage Time in Arms	1 <i>ms</i>
Test Masses	Fused Silica, 11 <i>kg</i>
Mirror Diameter	25 <i>cm</i>
Test Mass Period Pendulum	1 <i>sec</i>
Seismic Isolation System	Passive, 4 stage
Seismic Isolation System Horizontal Attenuation	$\geq 10^{-7}$ (100 <i>Hz</i>)
Maximum Background Pulse Rate	1 <i>per minute</i>

R&D Program

□ Overview

⇒ Demonstration Experiments

- Technical: Suspensions; Optics, Servos, ..
- Sensitivity: Displacement, Phase Noise

⇒ Priorities for Detector Design Freeze

⇒ Operations: Reliability, Stability

⇒ Develop Advanced Techniques

- Active Seismic Isolation

□ Progress and Plans

⇒ Optics, Test masses, Mirrors, etc

⇒ 40m Displacement Results

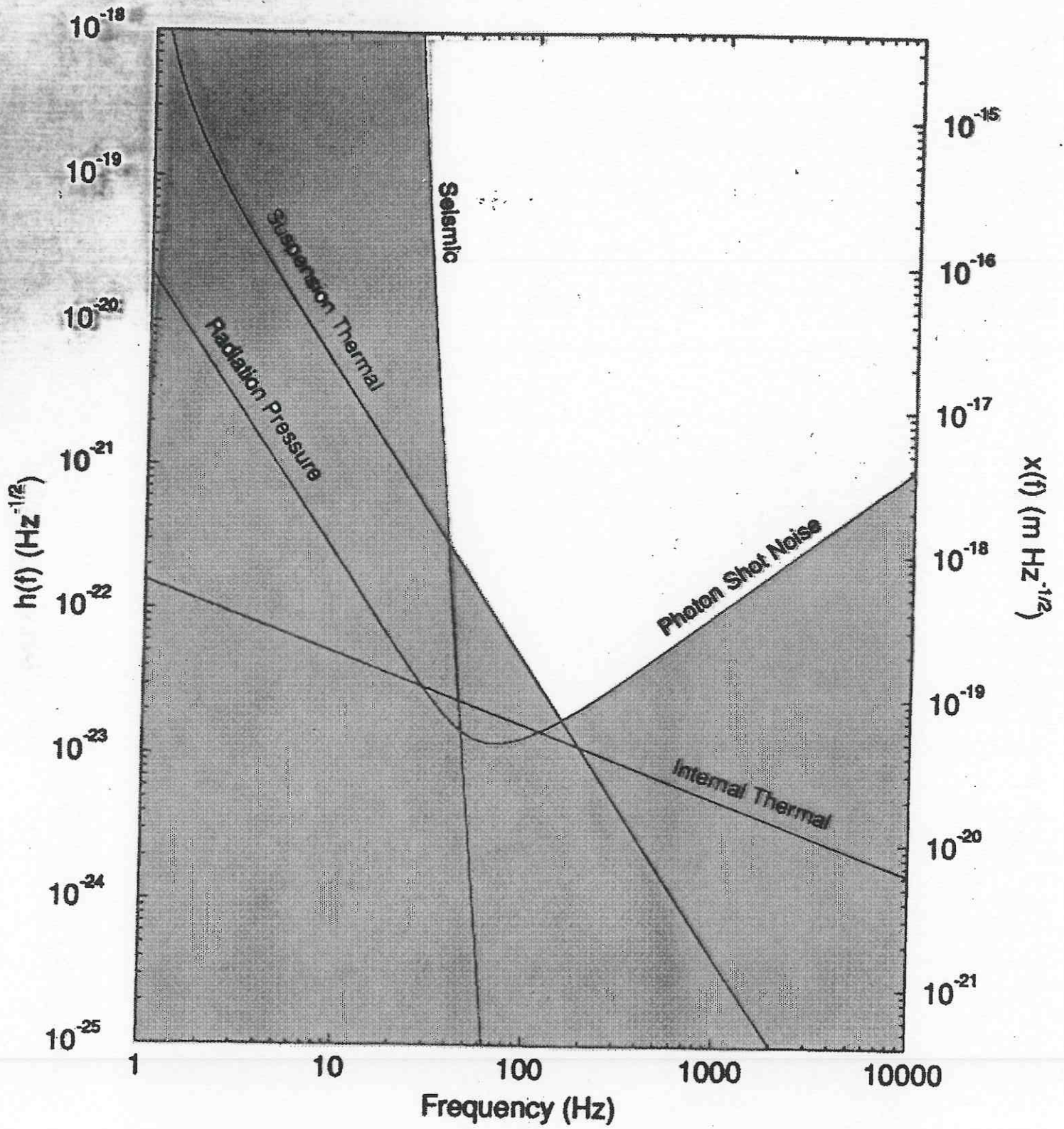

Displacement Sensitivity of Caltech 40 m Interferometer

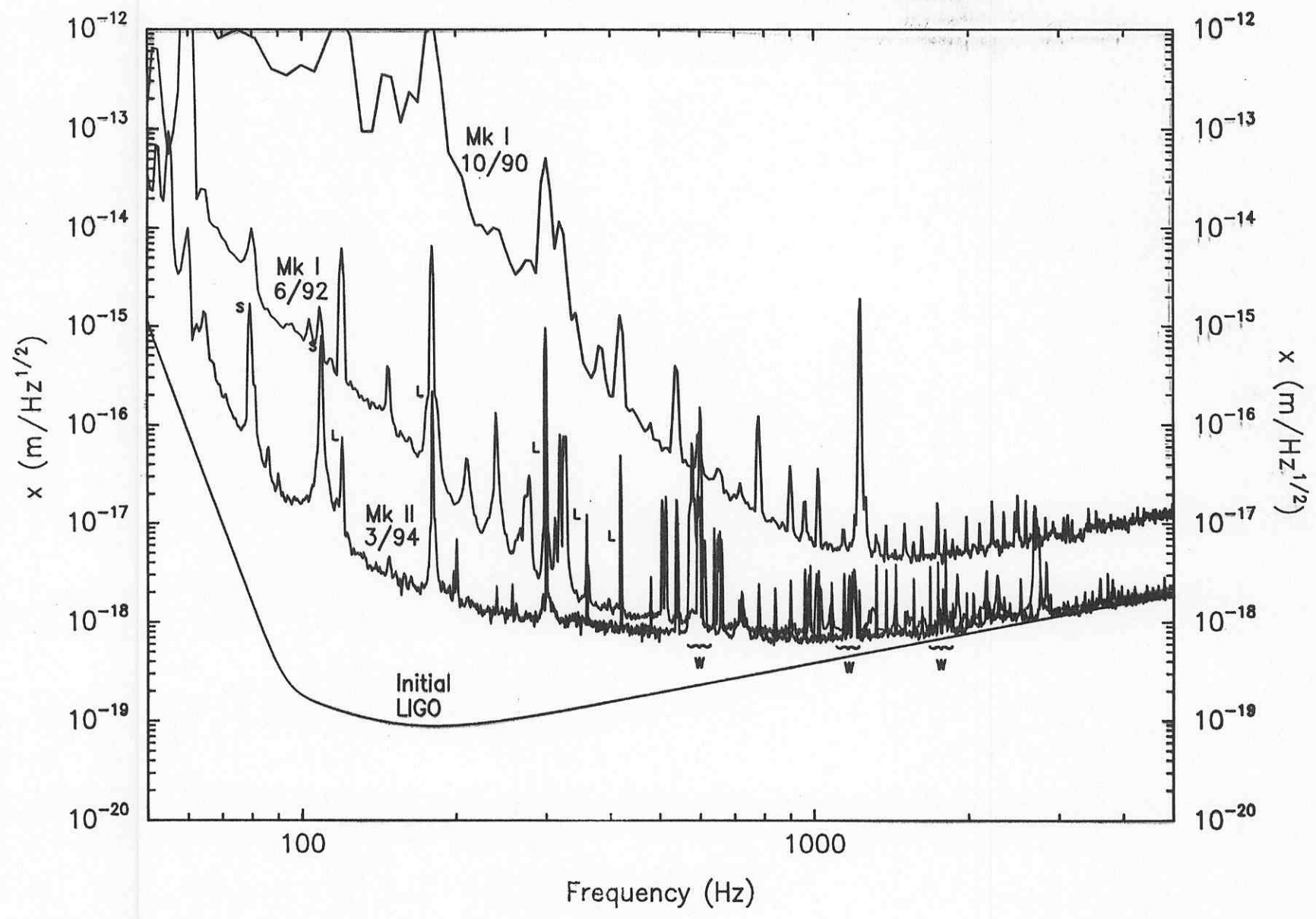

Displacement Sensitivity of 40-Meter Interferometer

Noise Model (9/15/94)

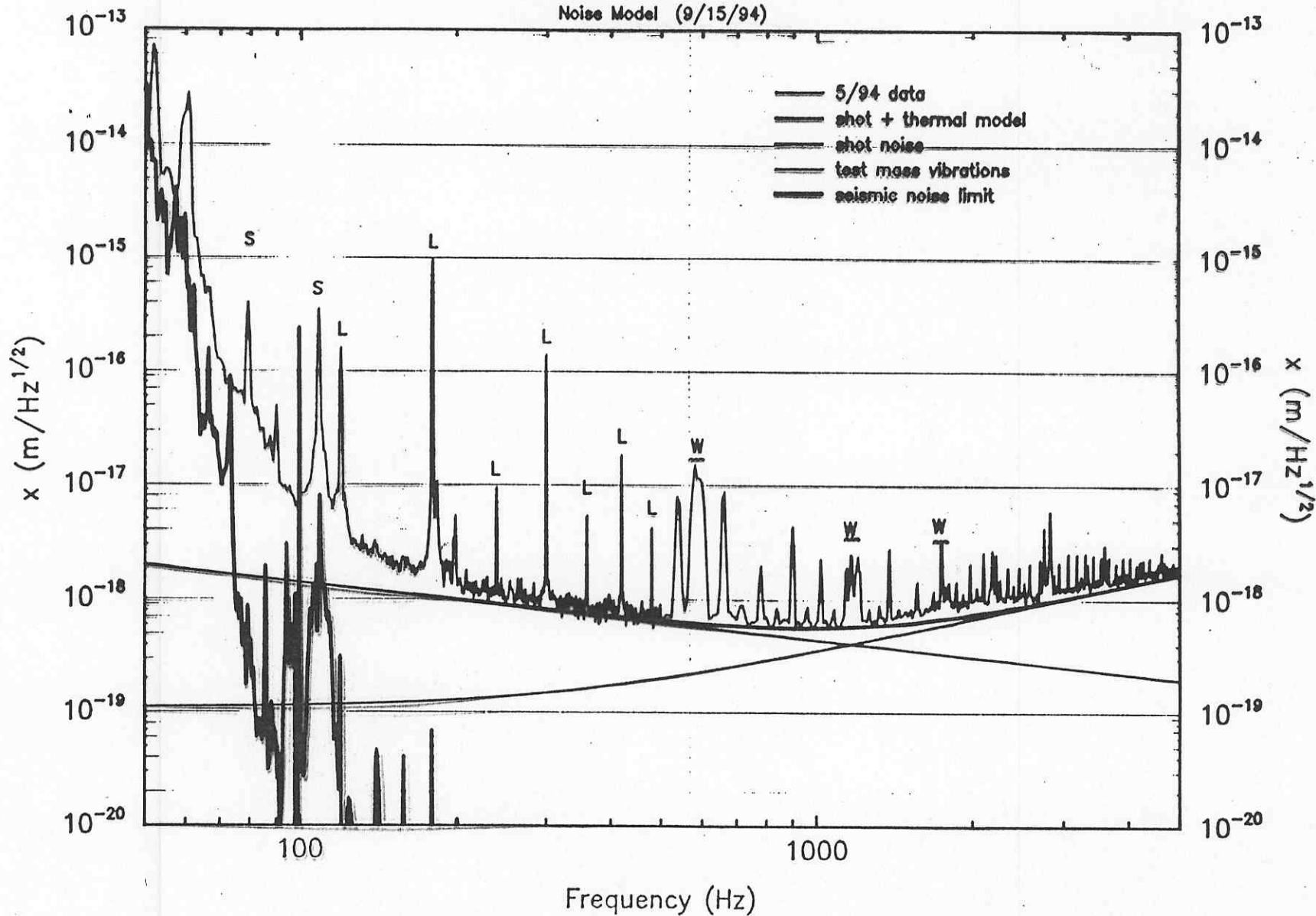

Reaching Design Sensitivity

□ Technical

- ⇒ R&D - Improvements
- ⇒ Engineering Design Improvements
- ⇒ Systems Engineering/Integration

□ Site Specific Factors

- ⇒ Length 4 km (factor of 100)
- ⇒ Environmental Factors (e.g.. Seismic)

□ Long Term

- ⇒ Reliability/Stability
- ⇒ Flexibility - Detector Improvements
- ⇒ Allow for Future New Detectors

MK2_PSL1_Control.adl

PSL SUBSYSTEM

Frequency
Intensity
Mode Alarms

FSS LCU

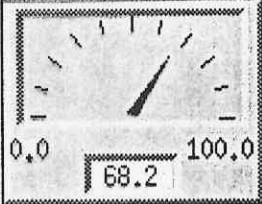
Scan
Gain
RF Photodiode
Reference PD
Visibility Monitor

0.0 68.2 100.0

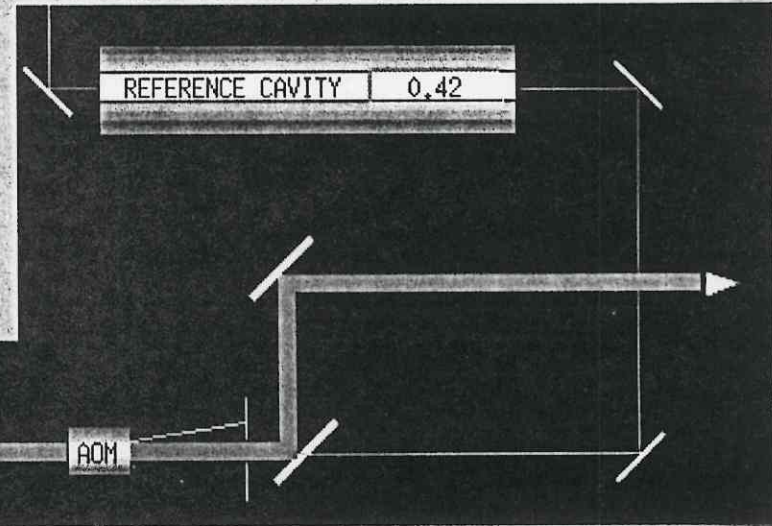
-0 RC Output PD



FPZT

ARGON ION LASER

SPZT

PC1

PC2

PC3

AOM

Laser LCU

LSQ: Laser OFF

LCU Mode
Laser PS
Laser Power (Watts)
Laser Current (Amps)
Laser Voltage (Volts)

Quad PD X
Quad PD Y
Temp Mon 1
Temp Mon 2
Temp Mon 3

PSS LCU

Lock Mode
Reference PD
PSA Output

TYPICAL GROUND MOTION SPECTRA

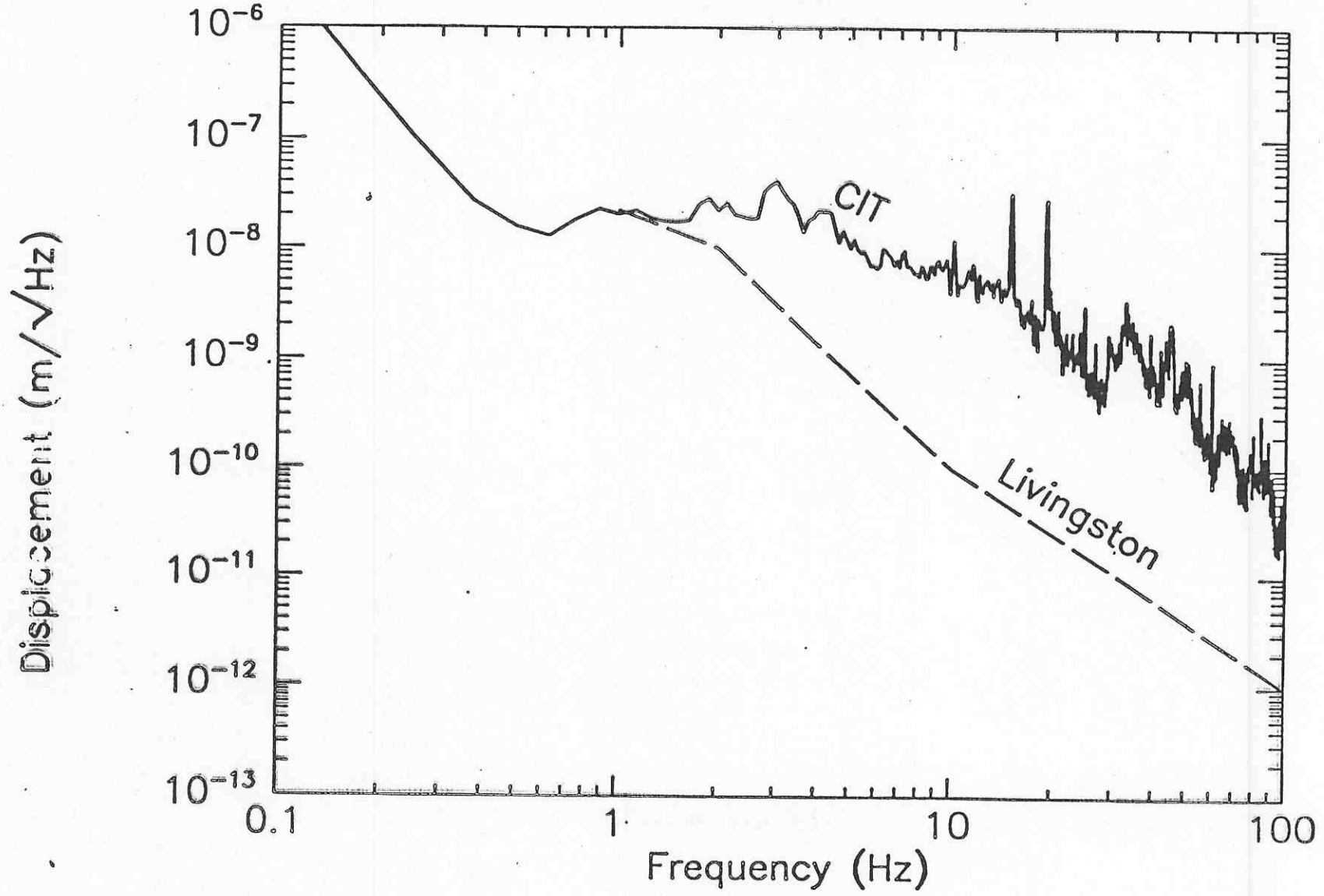

Hanford Corner Station SW Arm Axis, Late Night December 12, 1994 (Preliminary Data)

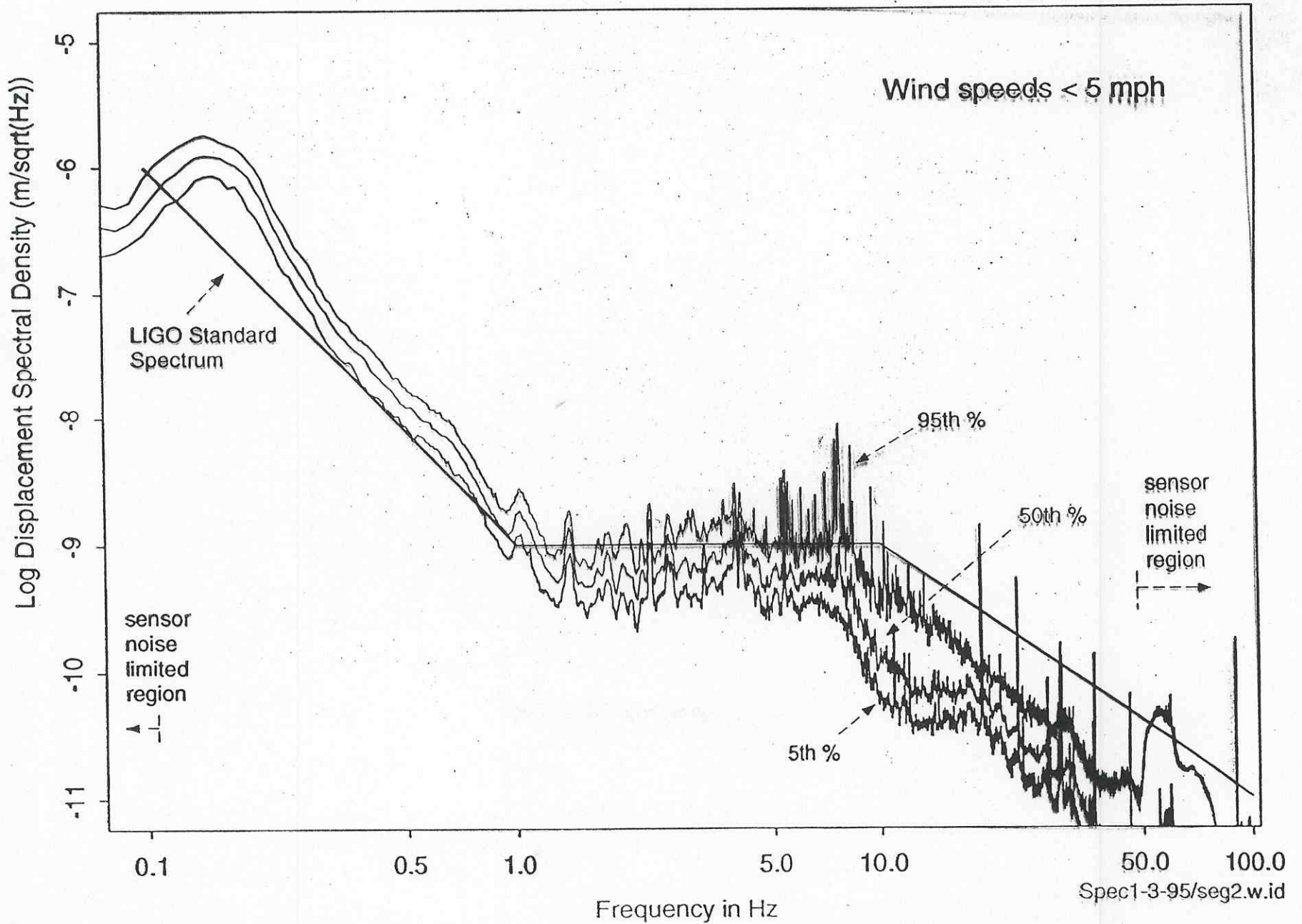

Hanford Corner Station SW Arm Axis, Morning Traffic December 13, 1994 (Preliminary Data)

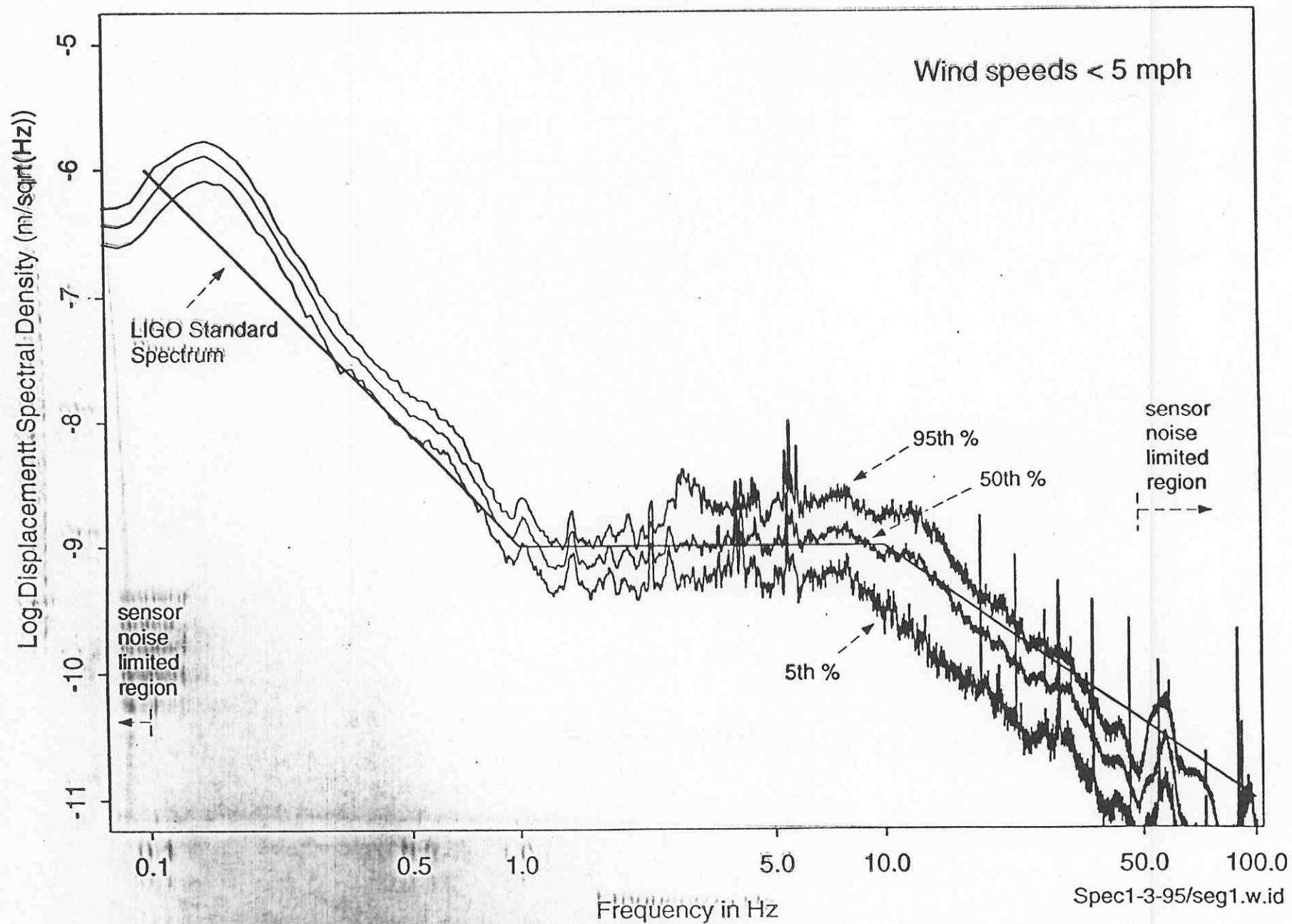

Suspension Thermal Noise

Observation of Thermal Noise in Violin Modes of 40-m Test Mass Suspensions

East End Mass Violin Resonances

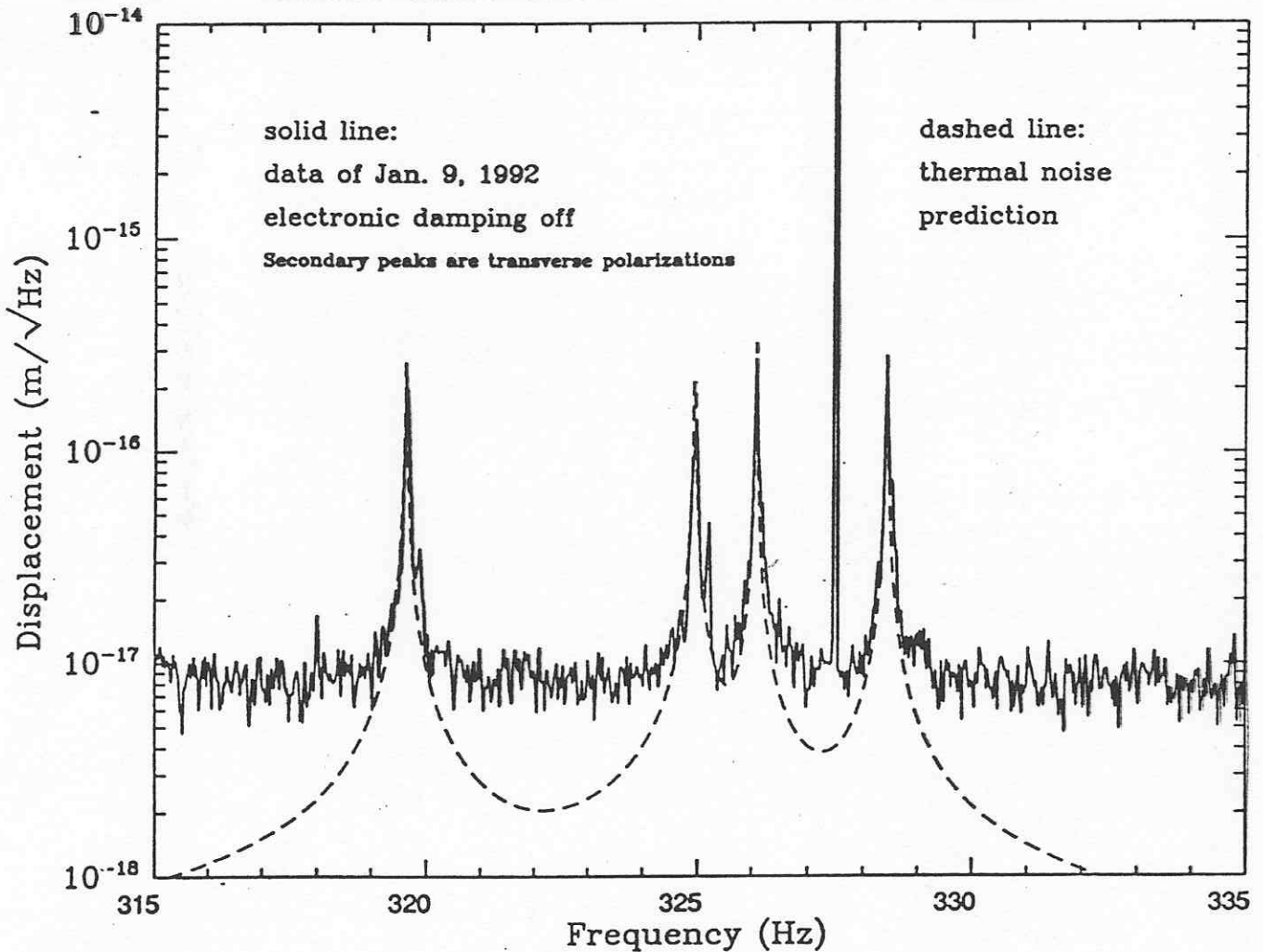

Suspension Thermal Noise For LIGO Interferometers

- Projected Thermal Noise for LIGO Interferometers
 - Model Suspension System Using Frequency Independent Loss Function
 - Use Current 40-m Suspension Design (Standoff on Test Mass and Clamps at Suspension Point)

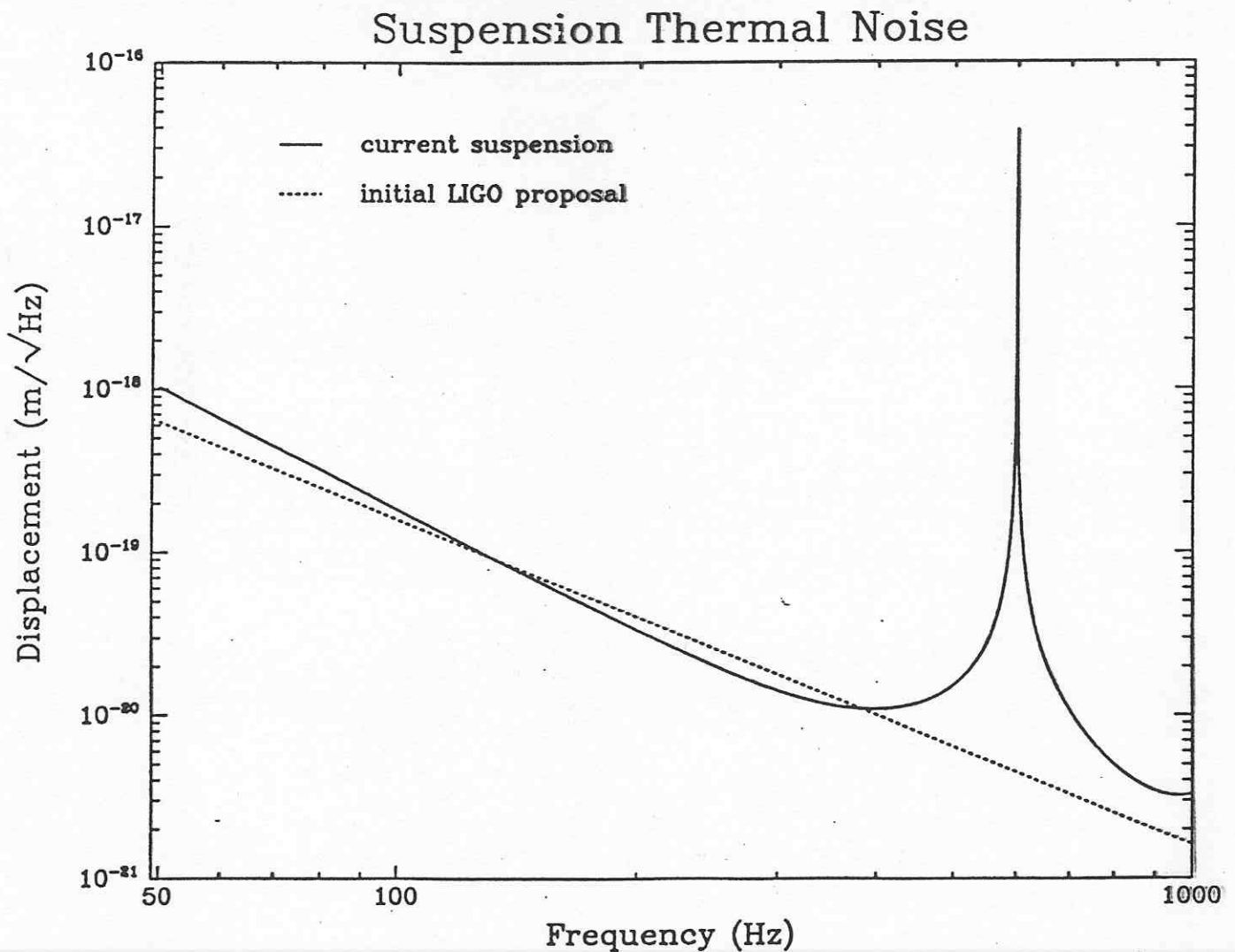

Phase Noise Demonstration

- **Goal is to Develop and Demonstrate Technology for Shot-Noise Limited Phase Measurements at Initial LIGO Interferometer Power Levels**
 - **Requires Development and Testing of Modulators and Photodetectors.**
- **Build Up 5-m Interferometer in Stages toward Full Recombined, Recycled Operation**
 - **Begin with Simple Michelson Interferometer Using LIGO Readout Scheme ($P_{\text{eff}} \sim 1 \text{ W}$)**
 - **Add Recycling Mirror ($P_{\text{eff}} \sim 15 \text{ W}$)**
 - **Reconfigure with Input Mode Cleaner ($P_{\text{eff}} \sim 70 \text{ W}$)**

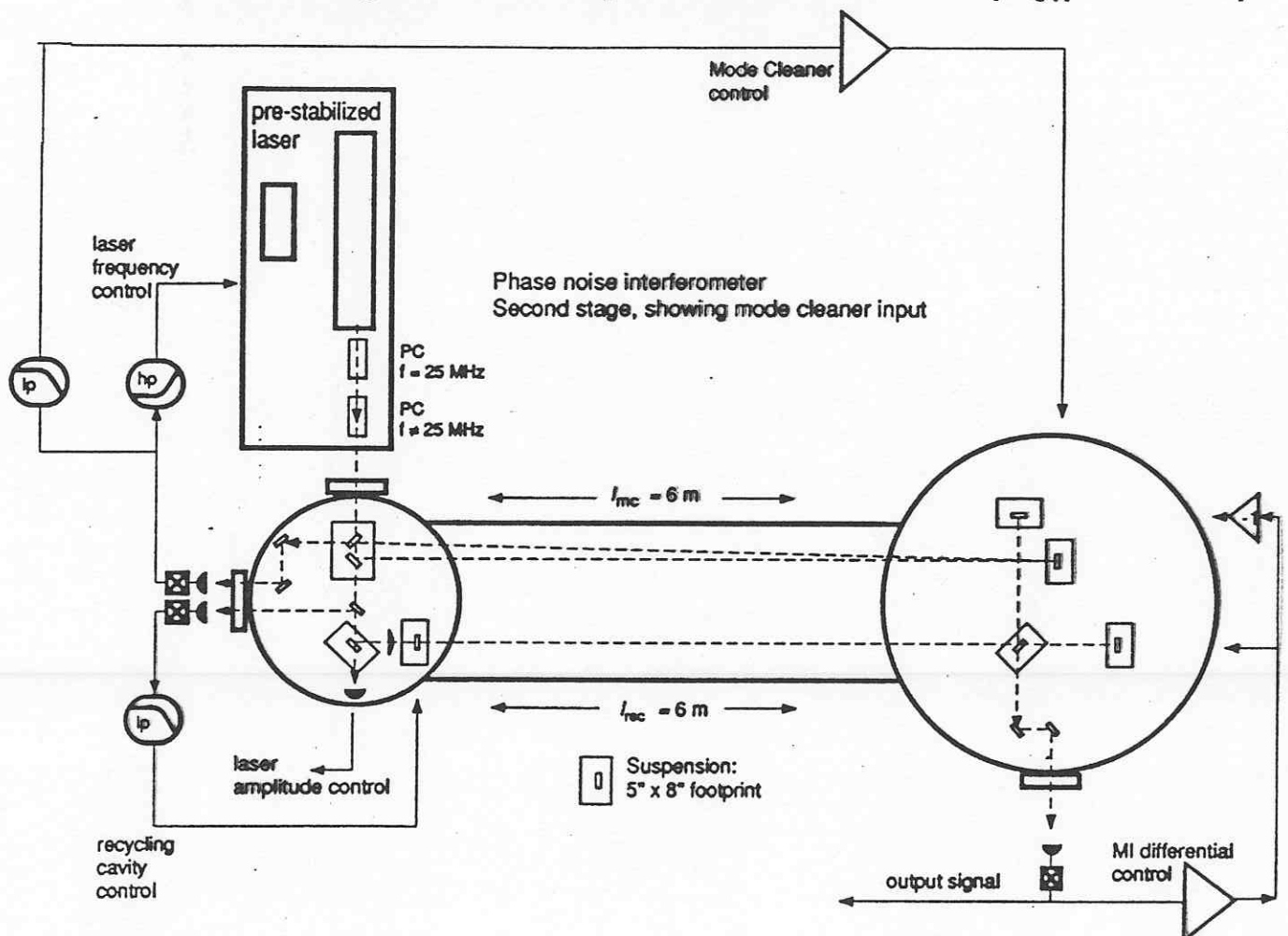

Shot Noise

$$\delta h(f) \approx \frac{1}{L} \left(\frac{\partial \phi}{\partial x}(f) \right)^{-1} \delta \phi(f)$$

PROPERTY OF
INTERFEROMETER

OPTICAL CONFIGURATION
(MIRROR R'S, ETC.)

DETERMINED PRIMARILY
BY EFFECTIVE OPTICAL
POWER

- Achieving Shot-Noise Limited Phase Sensitivity Requires Understanding and Control of All Other Optical Sources of Noise
 - Laser Noise
 - Photodiode Uniformity
 - Modulator-Induced Noise
 - Scattered Light

LIGO Requirement	$10^{-10} \text{ rad}/\sqrt{\text{Hz}}$
Current 40-m Interferometer	$10^{-8} \text{ rad}/\sqrt{\text{Hz}}$
MPQ Garching	$10^{-9} \text{ rad}/\sqrt{\text{Hz}}$

Optical Configuration Investigations

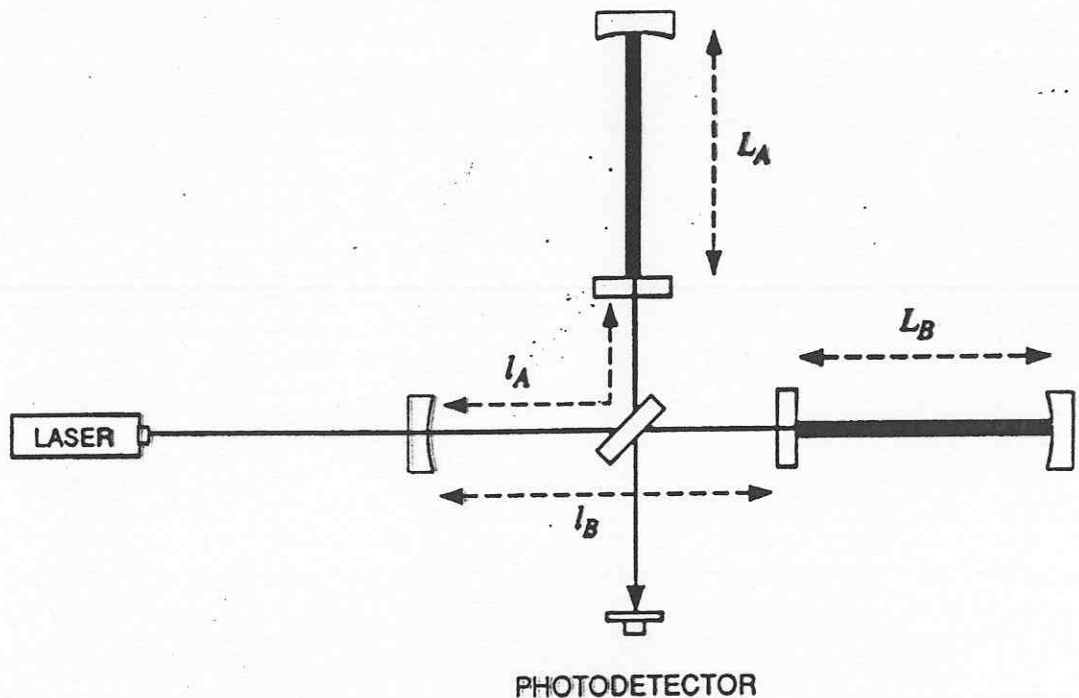

- **Must Control at Least Four Critical Lengths**
 - **Need to Specify Placement of Pick-offs, Photodetectors, and Modulators to Extract Required Control Signals**
- **In 1991, Started Efforts to Build and Test Two Possible Schemes in Tabletop Experiments For Comparison with Model Predictions of Performance**
 - **Test Signal Sizes, Servoloop Stability**
 - **Look for Gaps in Models**
 - **Not Practical to Test Noise Performance**

LIGO Project

- Major Facilities

- ⇒ Beam Tube
- ⇒ Vacuum Systems
- ⇒ Civil Construction

- R&D

- Detector

- ⇒ Interferometers
- ⇒ Control and Data Systems

- Project Management

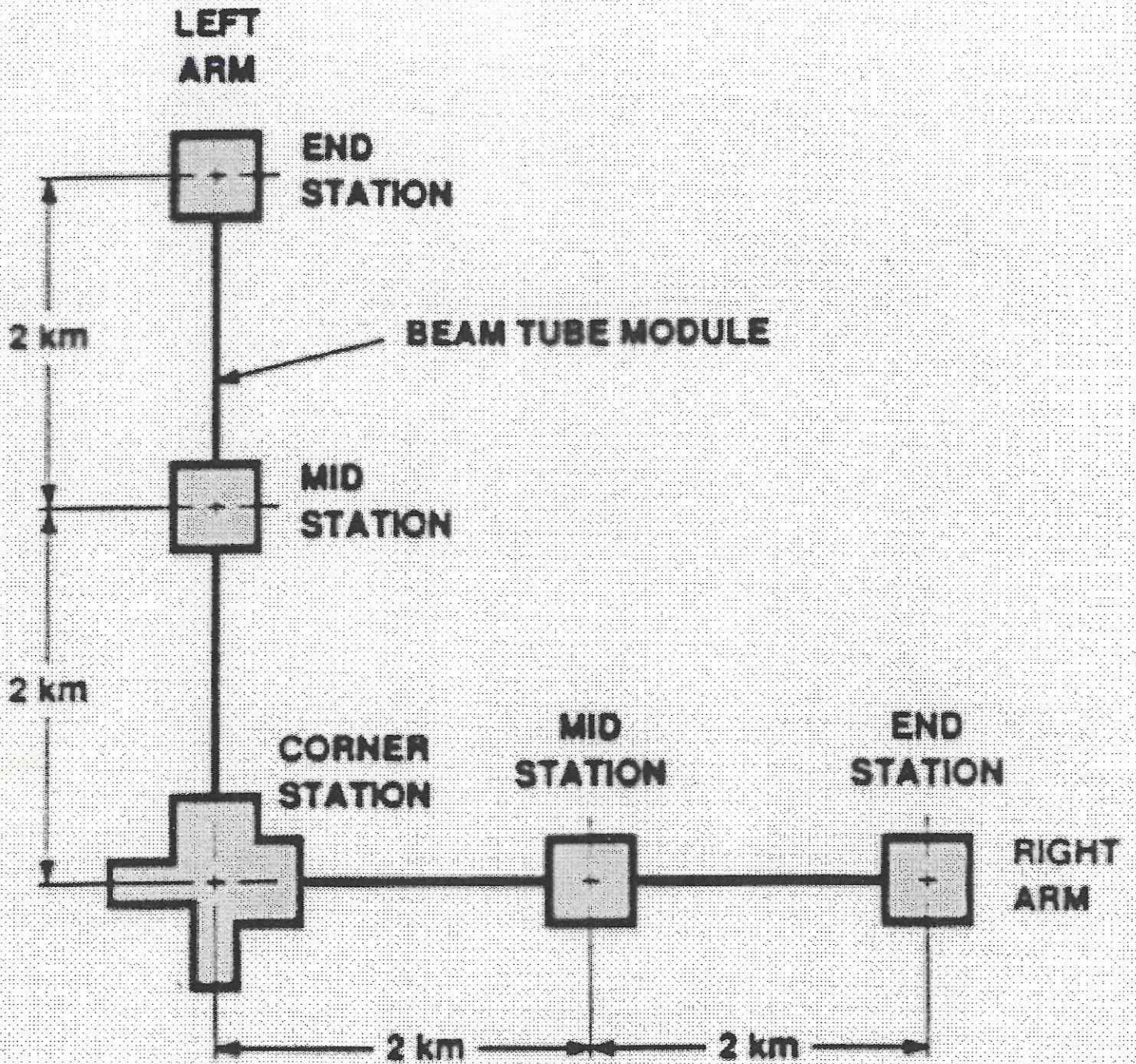

Beam Tube

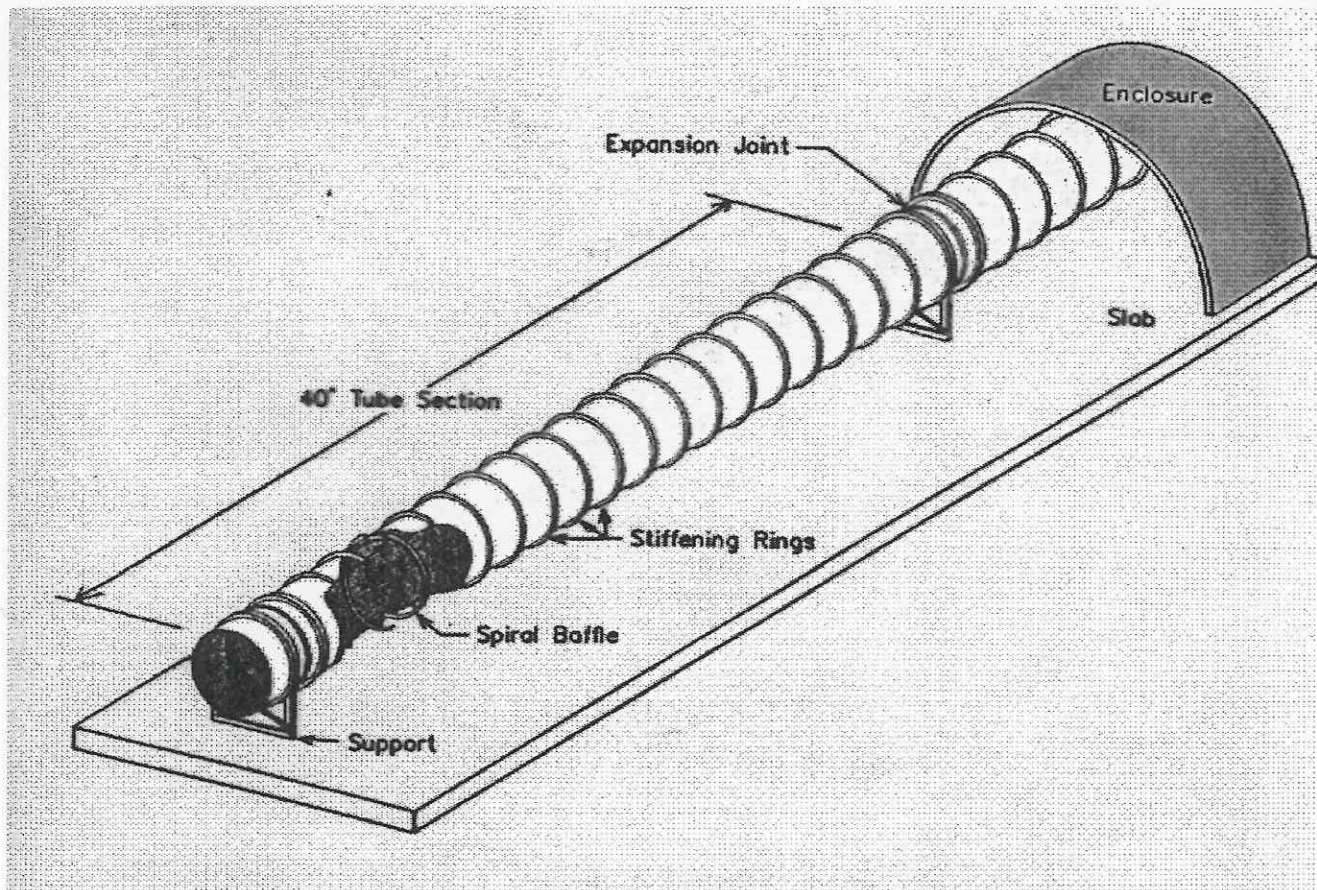

Beam Tube

□ Characteristics

- ⇒ Arm Lengths - 4km
- ⇒ Tube Diameter - 4 ft
- ⇒ Initial Detector
 - 10^{-6} torr Hydrogen; 10^{-7} torr Water
- ⇒ Advanced Detectors
 - 10^{-9} torr Hydrogen; 10^{-10} torr Water
- ⇒ Quality Control
 - (materials, welding, cleaning, etc)

□ Status and Plans

- ⇒ Design Contract was with CBI
 - Final Design Report Accepted (6/94)
- ⇒ Qualification Test
 - 130 ft Section - success (4/95)
- ⇒ Contract Options

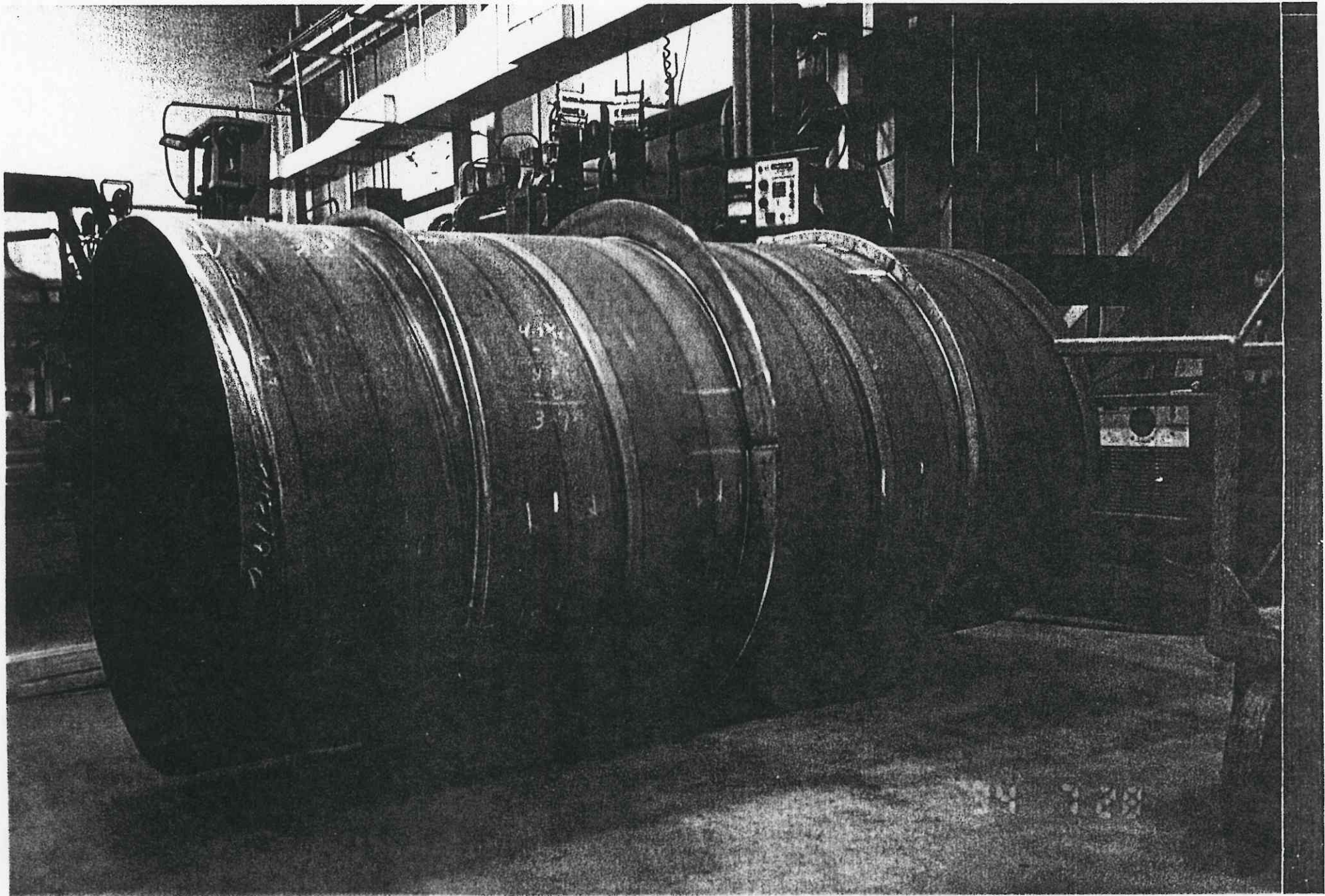

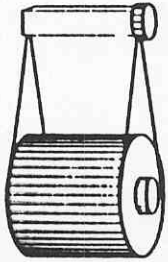

1

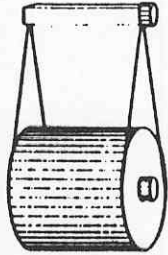

2



3



4



5



6

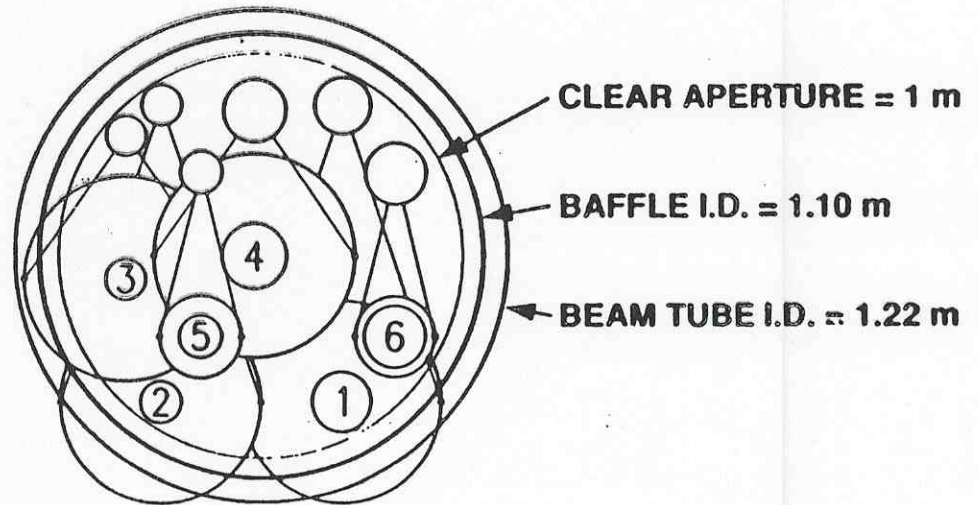
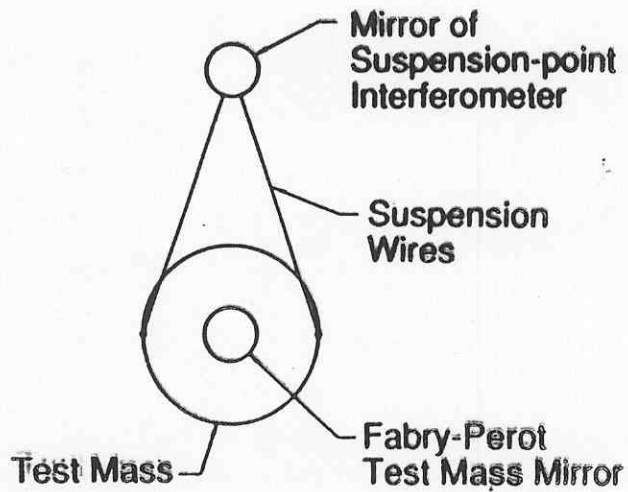

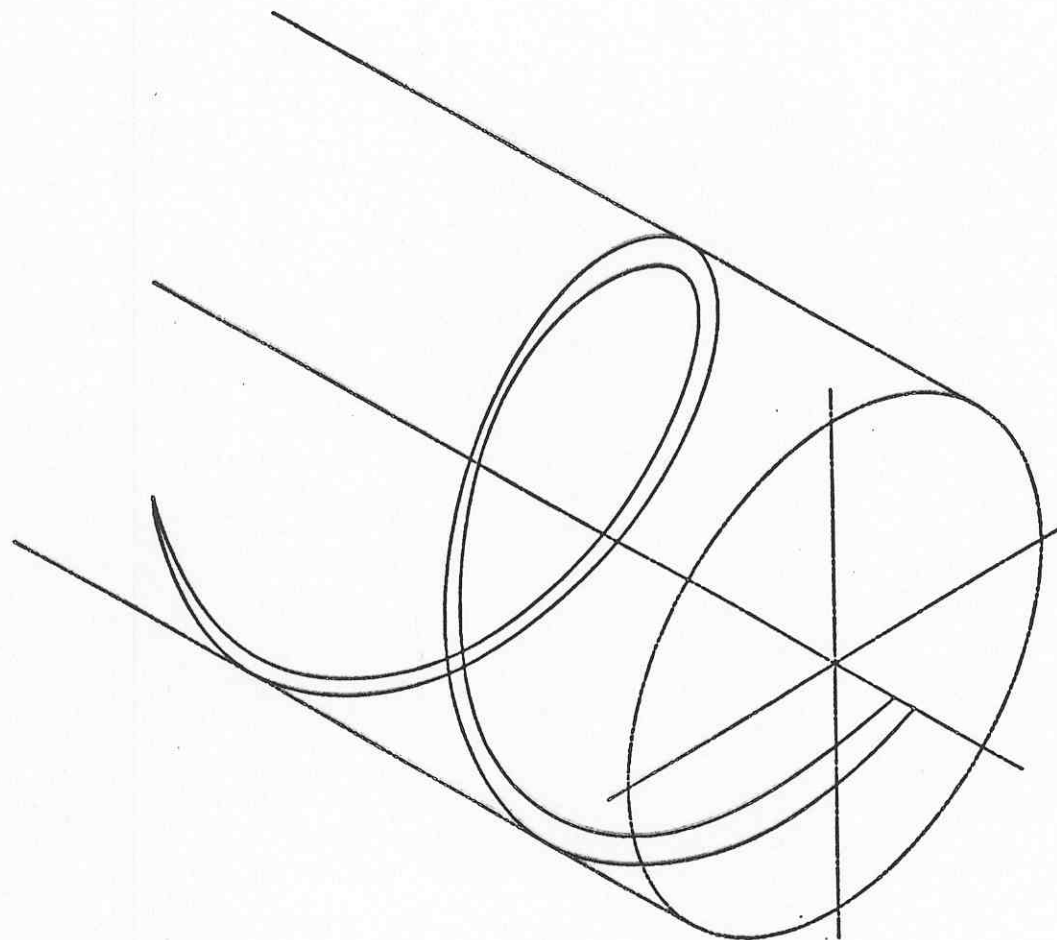
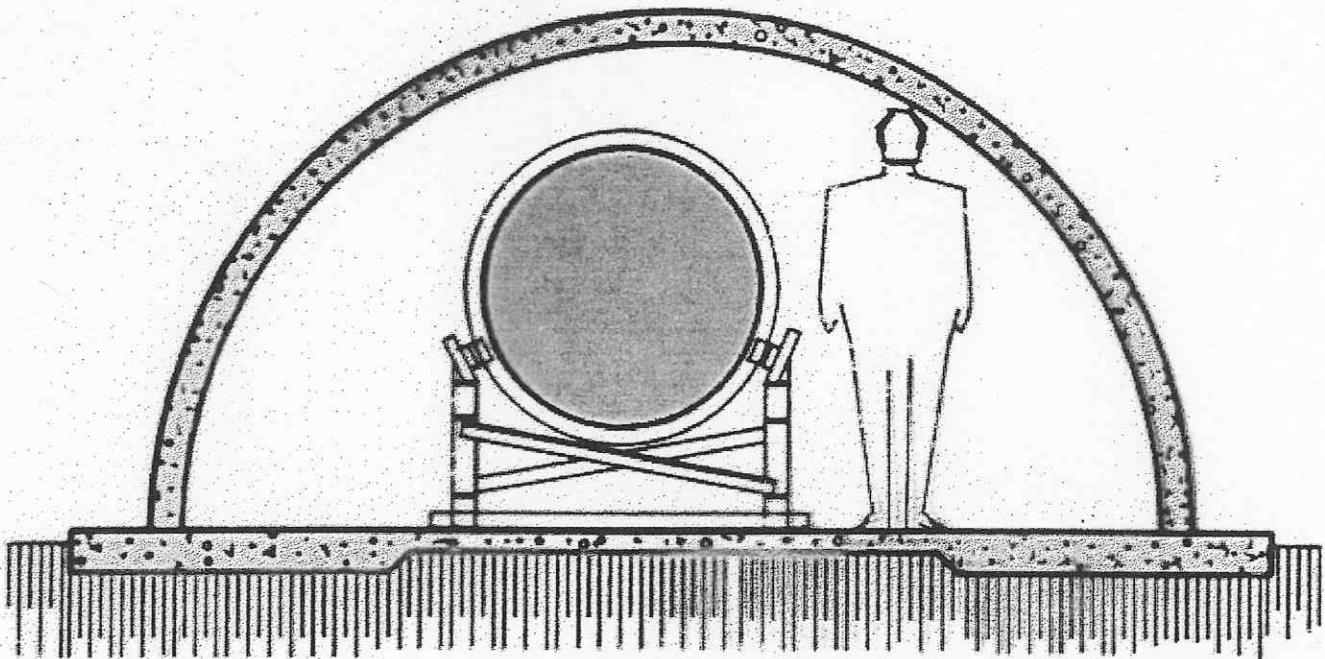
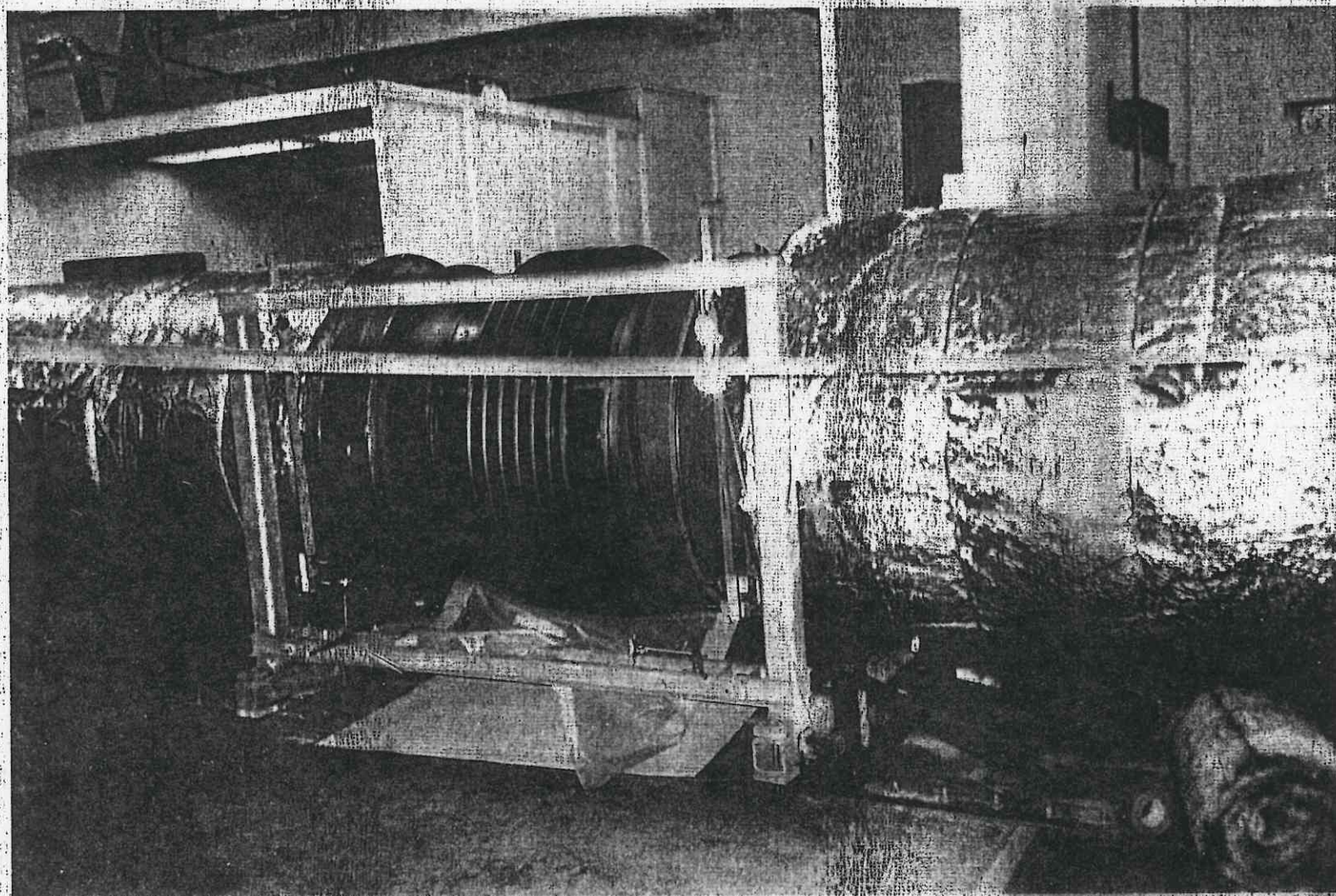

FIGURE 1.1.2 #4 BAFFLE SCHEMATIC

Beam Tube Enclosure





Vacuum Equipment

□ Characteristics

- ⇒ Enormous Volume (~20,000 m³)
- ⇒ Mostly Standard Vac. Equipment
 - 1st stage roughing - Atm -> 0.1 torr
 - 2nd stage roughing - 0.1 torr -> 10⁻⁶ torr
 - Steady State - Ion/getter pumps.
- ⇒ Large Gate Valves (4ft diam)
 - access and flexibility
- ⇒ Controls and Monitoring

□ Status and Plans

- ⇒ Specifications Defined
 - Science Review Complete - Aug '95
- ⇒ RFP for Design and Manufacturing
 - CBI and PSI awarded design contracts
 - Down-select 6/95

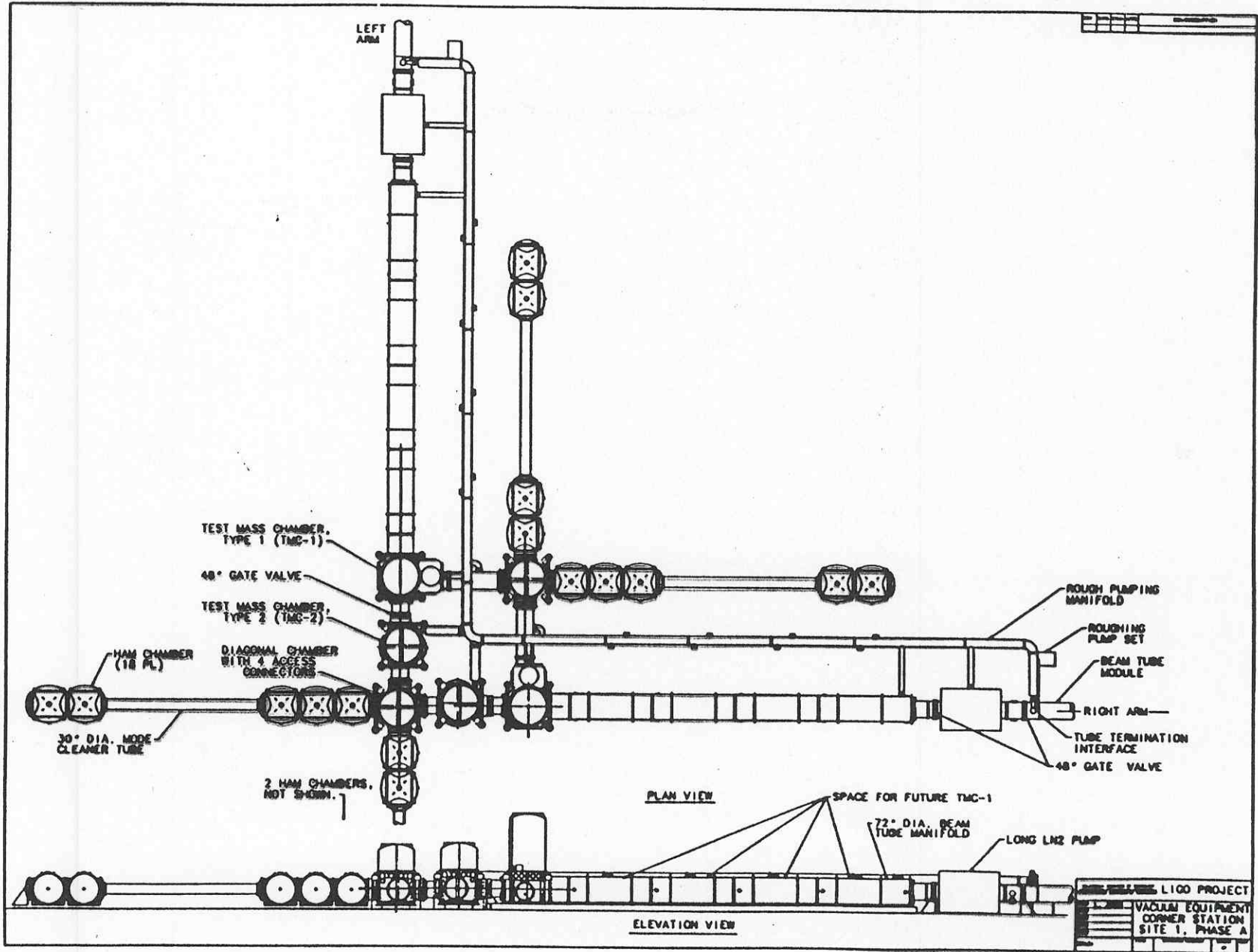

LIGO PROJECT	
VACUUM EQUIPMENT	
CORNER STATION	
SITE 1, PHASE A	

EDITION 11-5-92

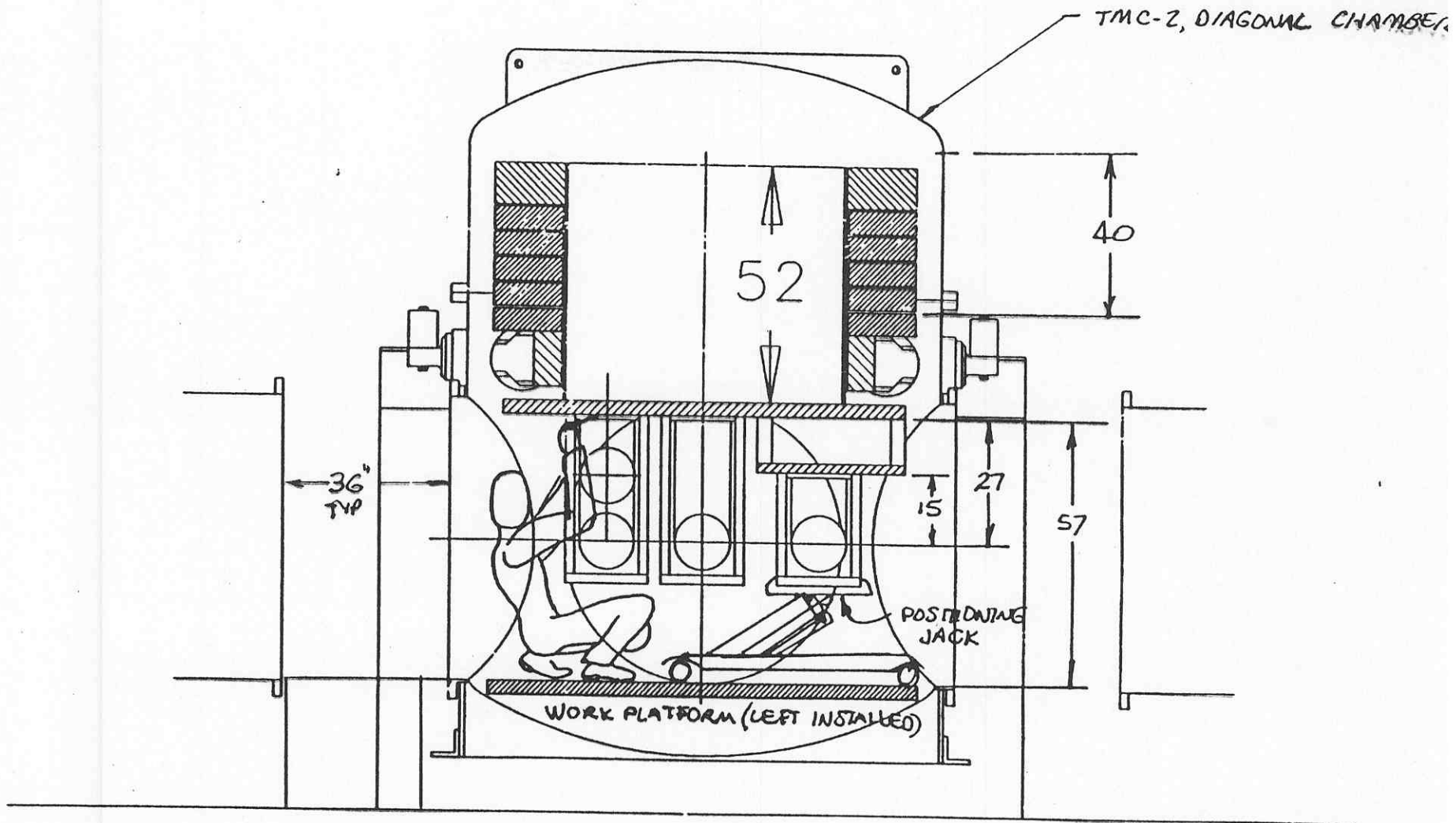

FIG. 3 INTERNAL ACCESS

SD
9-2-92

Civil Construction

□ Characteristics

⇒ Structures, Foundation, Roads, etc

- Large and Clean Laboratory Bldgs
- Beam Enclosures
- Office/Lab Space

⇒ Requirements

- Seismic Stability, Noise Sources, etc
- Cleanliness

□ Status and Plans

⇒ Both Sites Acquired

- Grading - Wash; Clearing in Louisiana

⇒ Design/Const. Management

- Awarded to Parsons (Nov 95)

⇒ Conceptual Design -

- 90% A&E received 4/95
- Trade Studies; Value Engineering

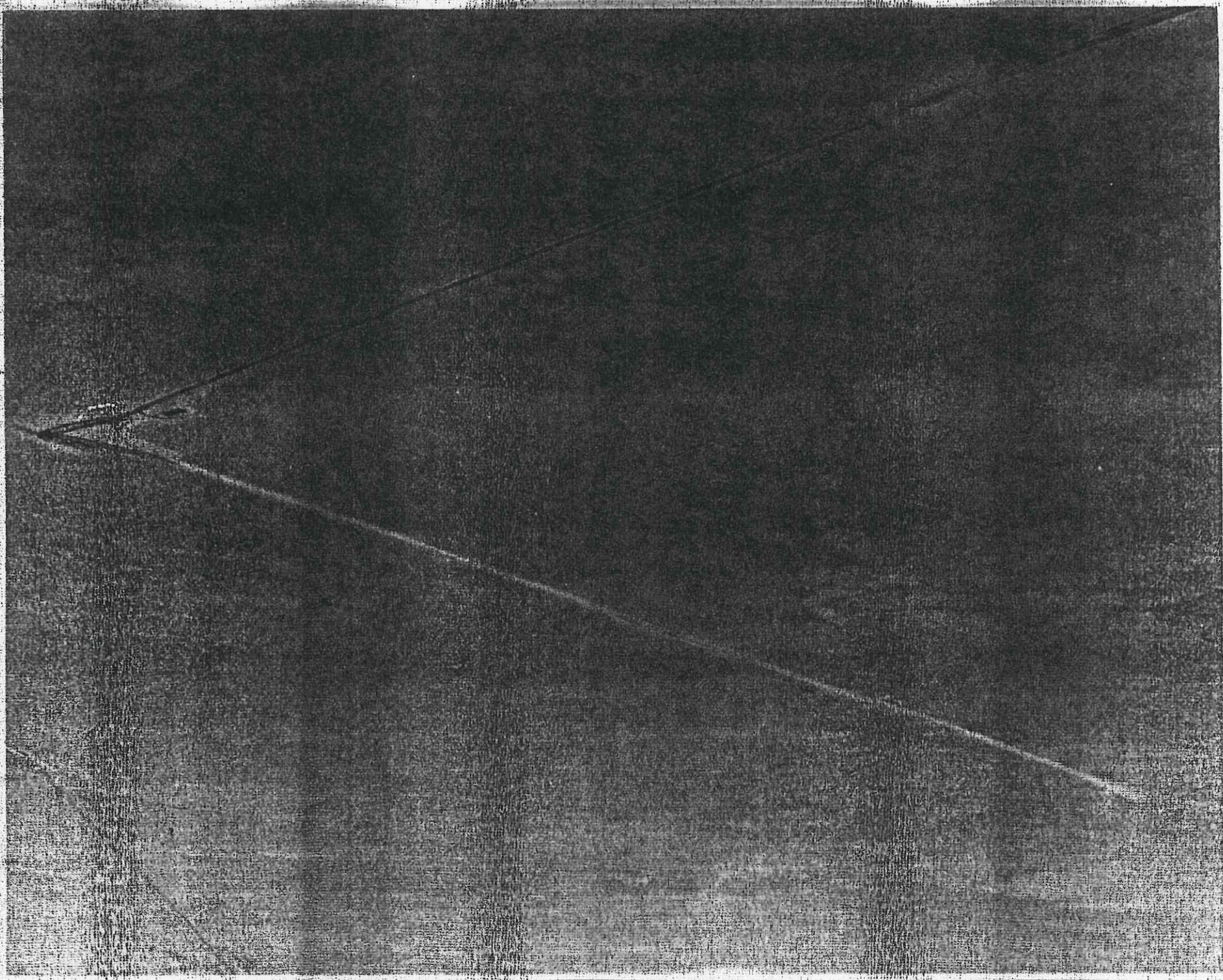

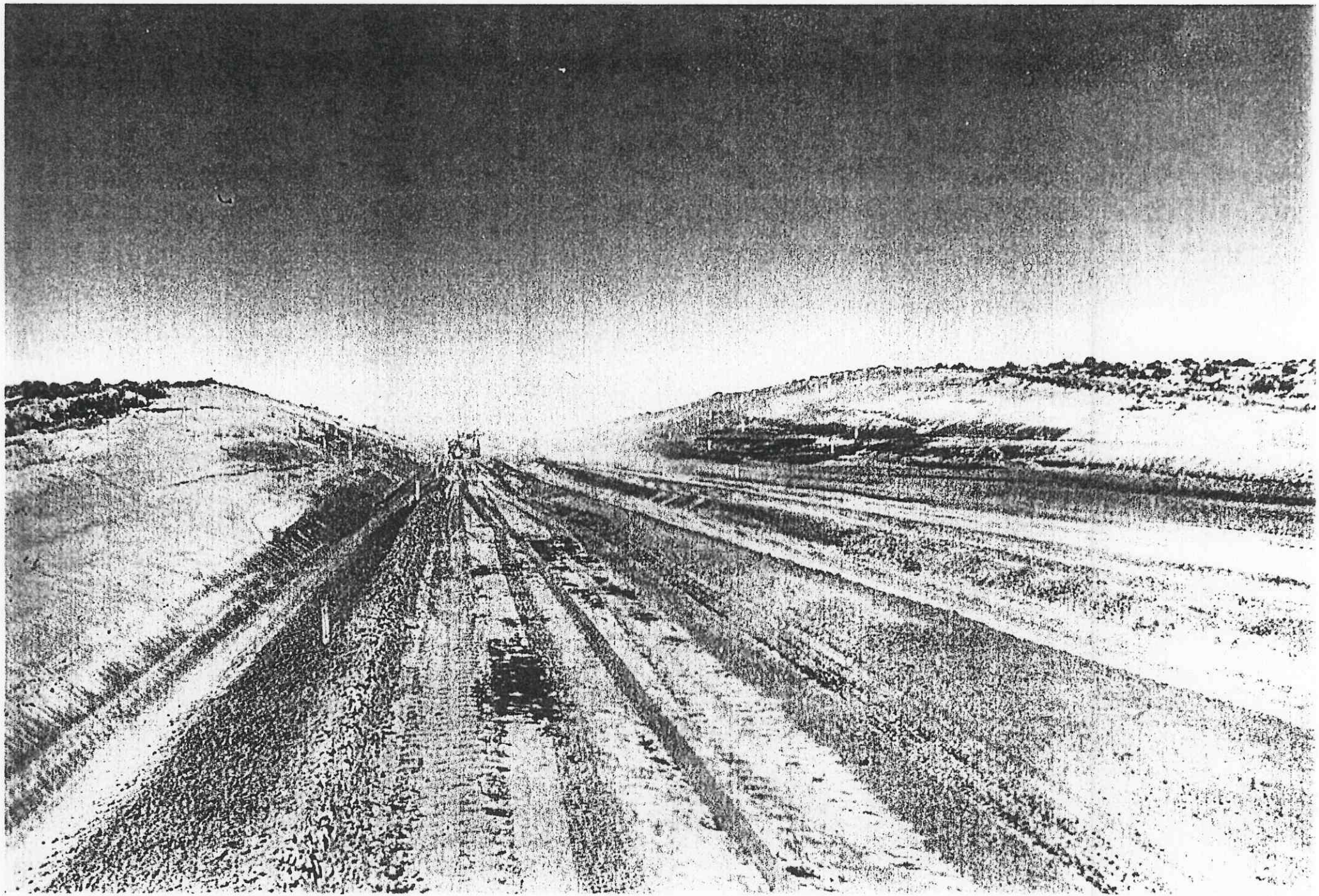

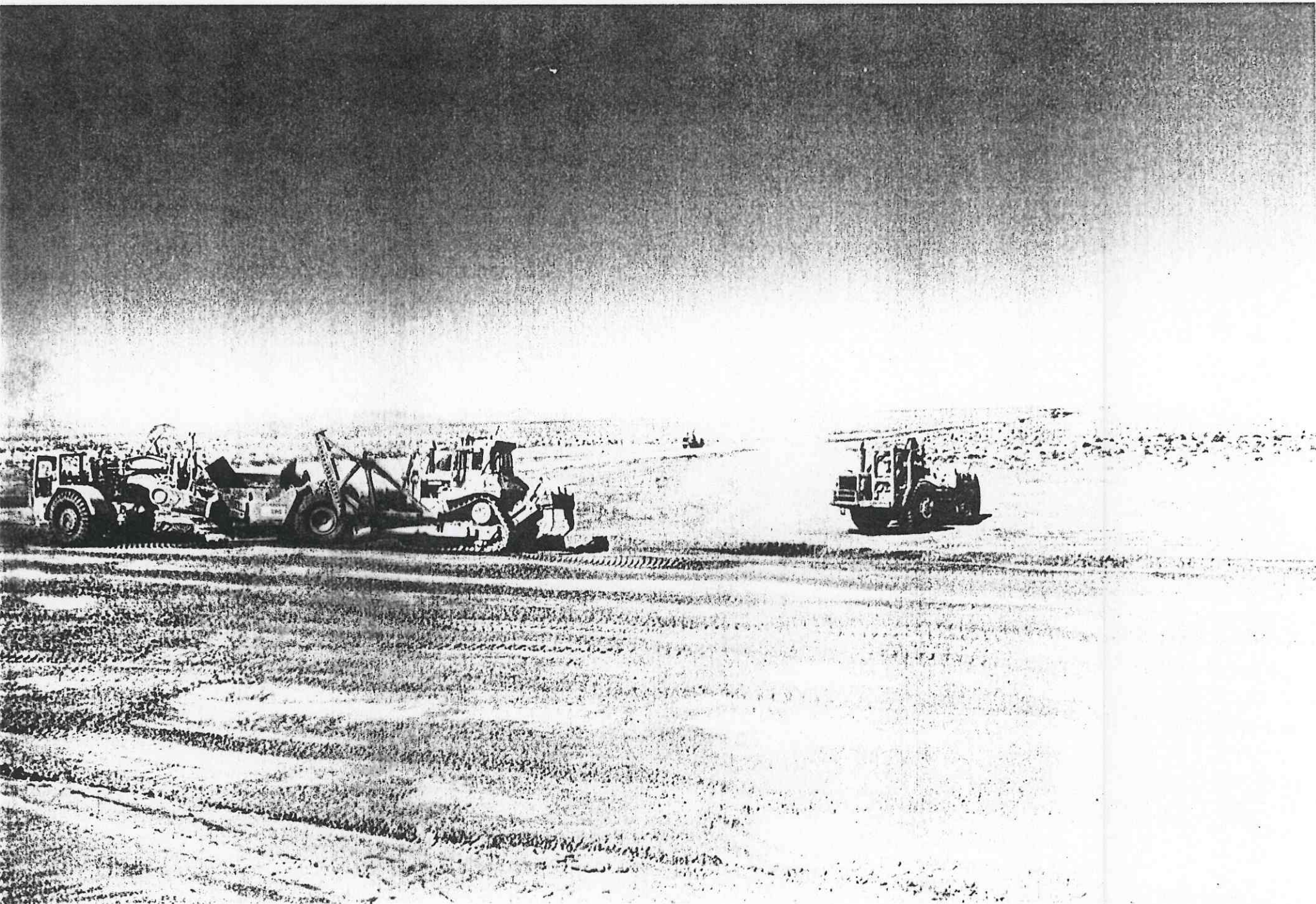

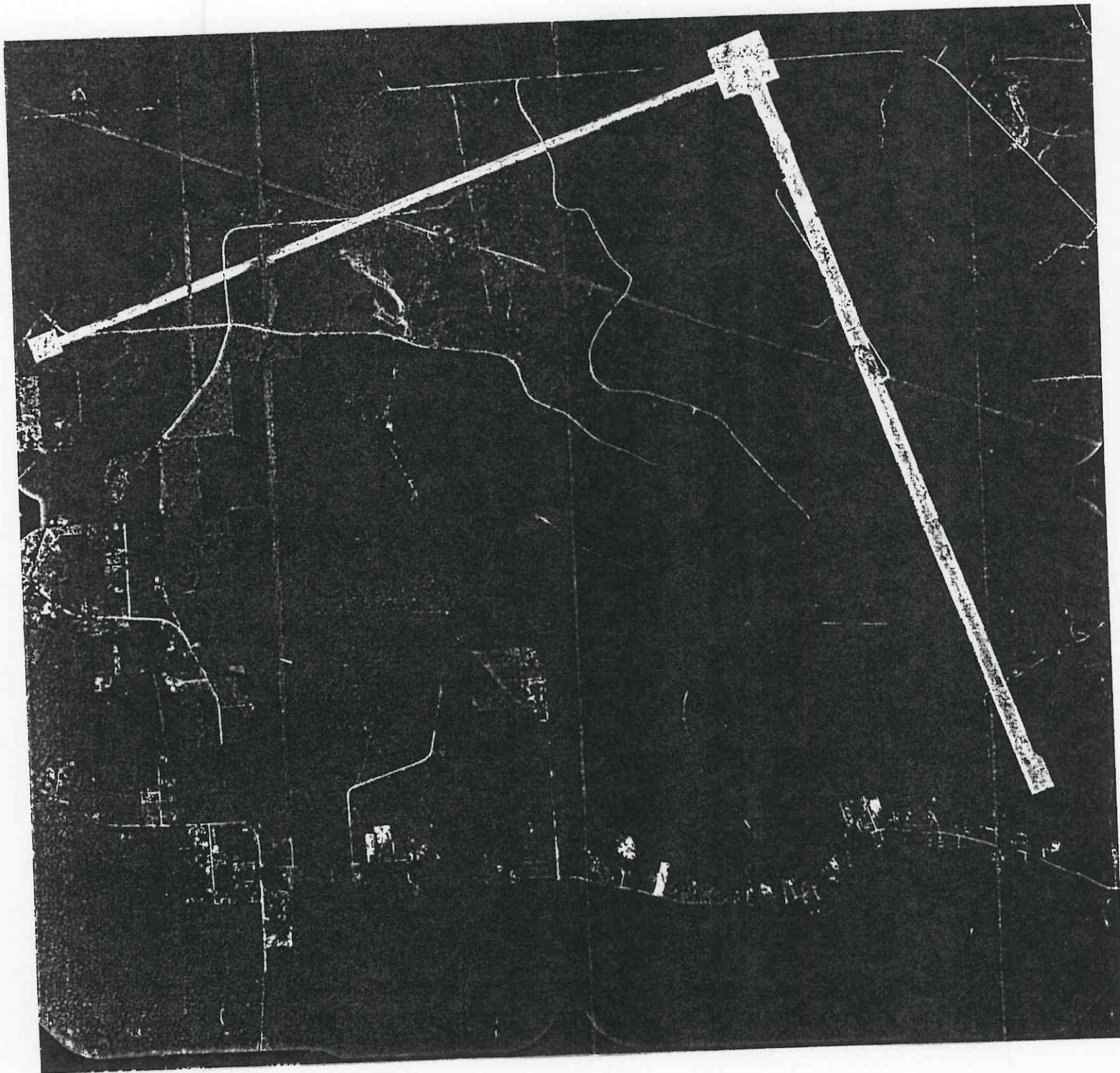

LIGO

LIVINGSTON PARISH

LOUISIANA

1A

AERIAL PHOTO BY:

GULF COAST AERIAL MAPPING

FLOWN: AUGUST 25, 1995

ALTITUDE: 12,000 FEET

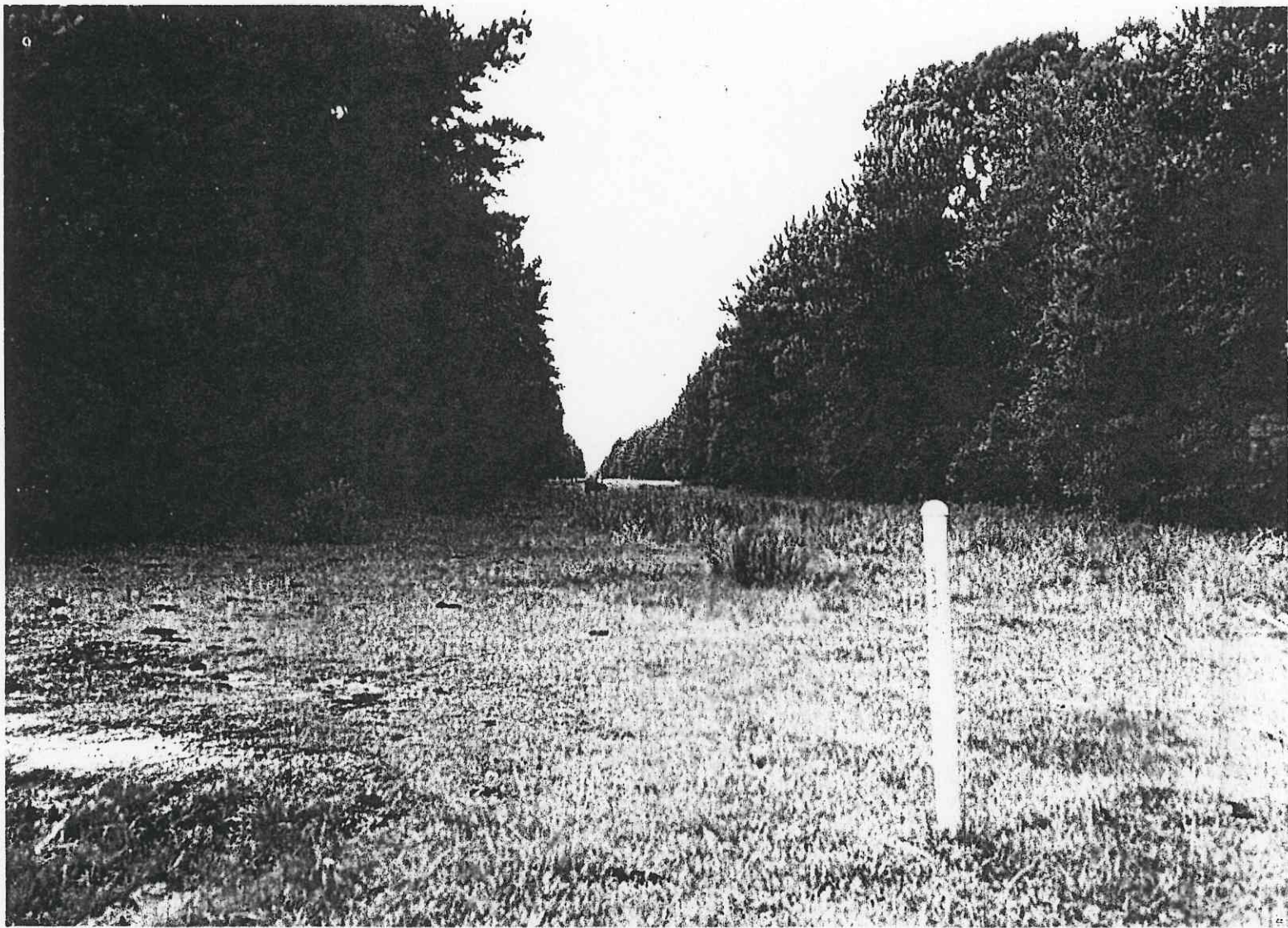

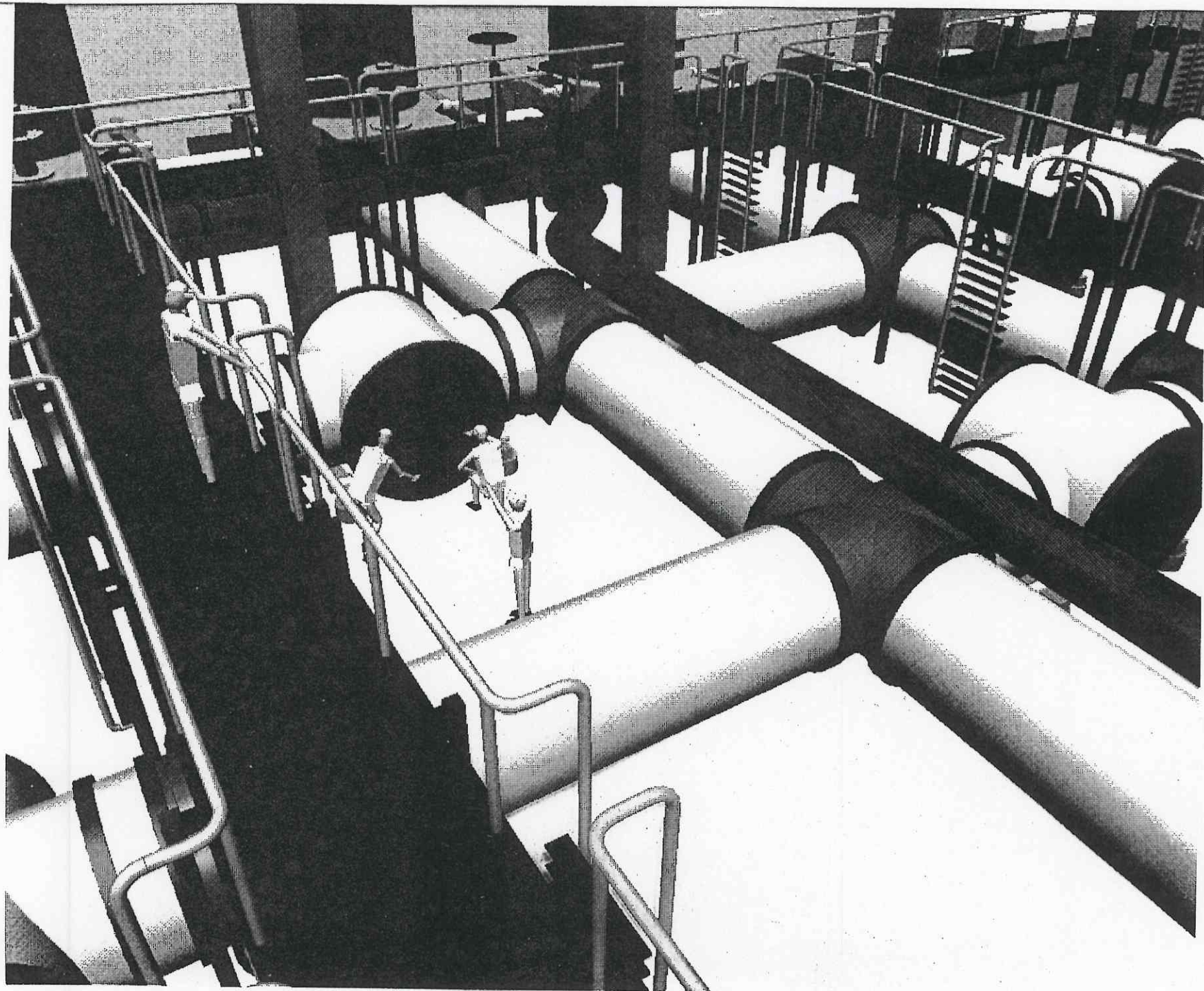

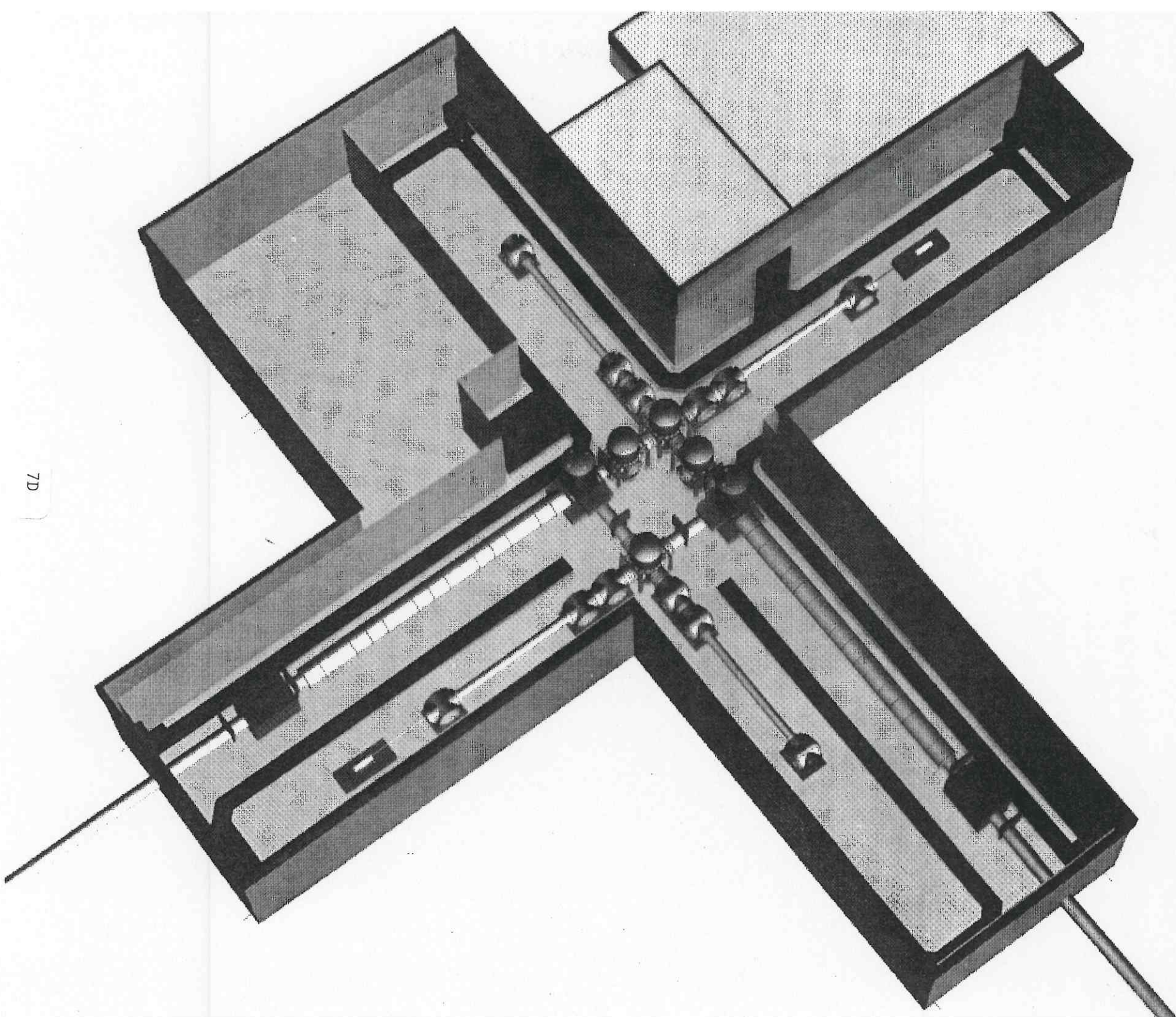

7D



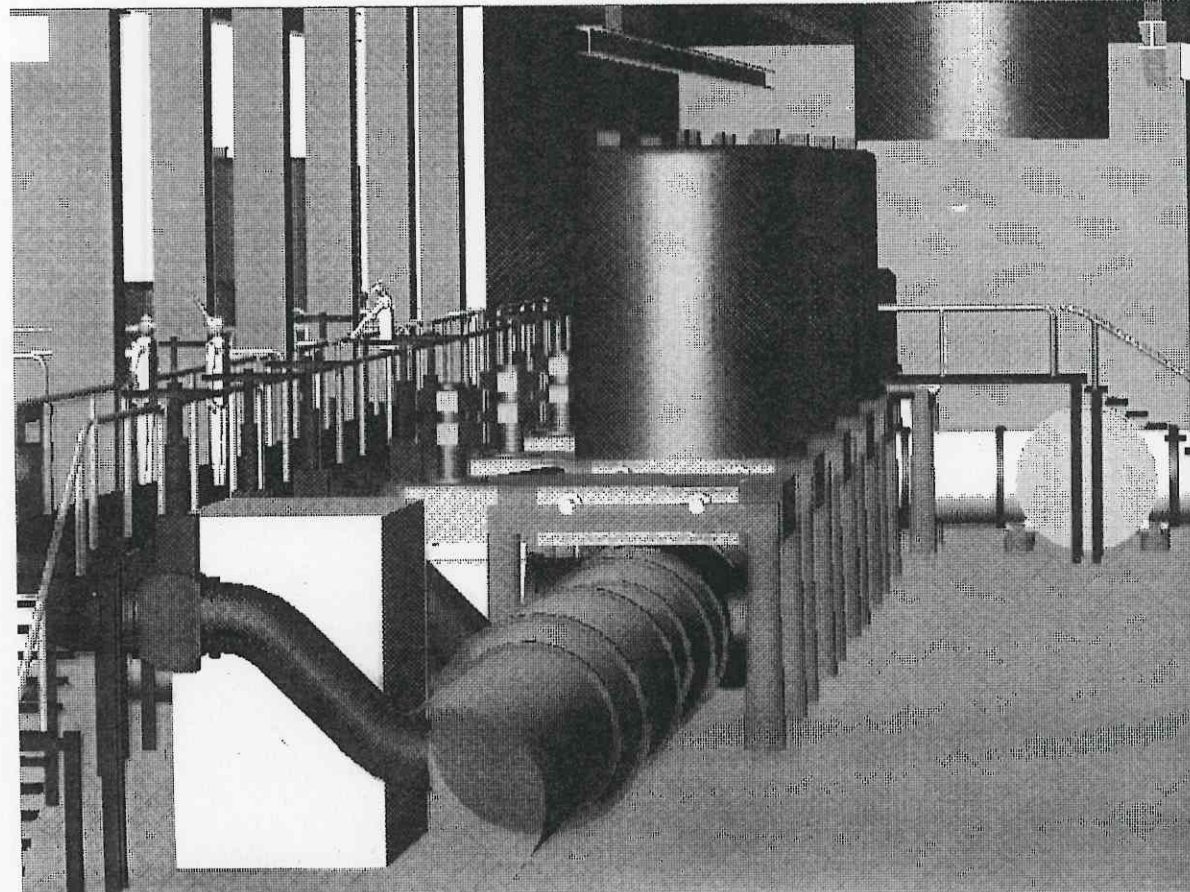
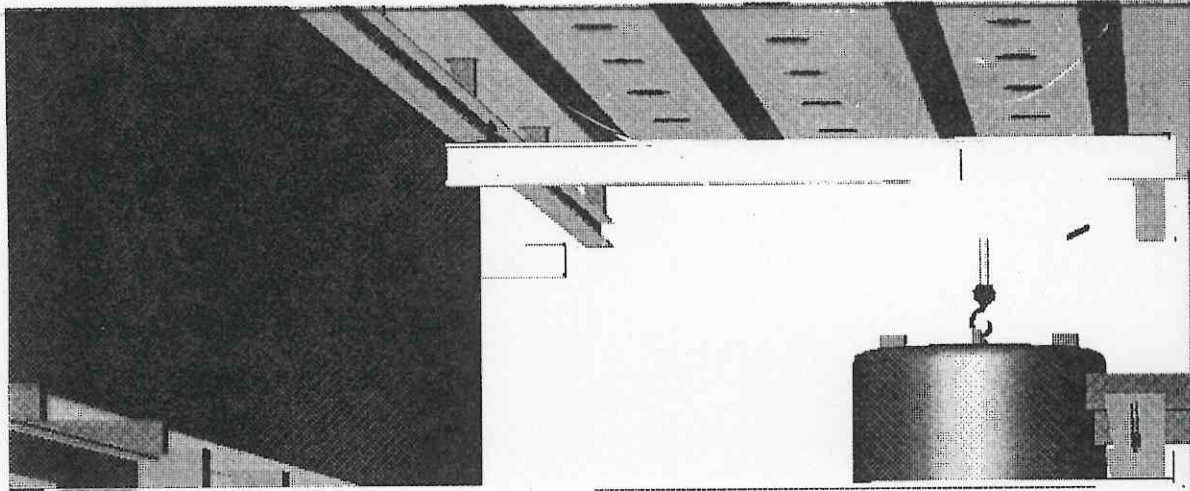

Project Status and Plans

- Ready for Construction Phase
 - ⇒ Acquisition Plans; Designs; etc

- Construction Project
 - ⇒ Complete in 1999

- Operations
 - ⇒ Begins as Construction is Completed
 - ⇒ Operational for Science during 2000
 - ⇒ Design Goal by end of 2001

LIGO Detectors

R&D Program

- Sensitivity
 - » main features of 40 m spectrum understood
 - » monolithic test masses improve sensitivity
- Demonstration Experiments
 - » optical recombination demonstrated on 40 m
 - » acquisition locking with LIGO controls
 - » MIT phase noise experiments underway
- Pre- [detector design freeze]
 - » Program testing directed at tasks that could effect design over the next two years
- Post- [detector design freeze]
 - » Program directed at improved sensitivity; experience running an interferometer facility

Where Do We Stand? (Fundamental Noise Sources)

- **Seismic Noise**
 - Passive Seismic Isolation Stack Understood
 - Stacks with Softer Elastomer in Preparation
 - Significant Reduction in Seismic Background at Remote Sites
 - Projected to Meet Initial LIGO Goal
- **Thermal Noise**
 - Improvements in Quantitative Understanding
 - Suspension Requirements Relaxed, Internal Mode Requirements Tightened
 - Current Suspension Design Projected to Meet LIGO Goal
- **Shot Noise**
 - LIGO Goal 10× Better than Best Demonstrated
 - Requires Characterization and Integration Of Different Electro-Optical Components and Subsystems (Photodetectors, Modulators, Laser Stabilization, . . .)
 - High Power Shot Noise Experiment Underway at MIT

Improvement Toward Advanced Interferometers

Initial Interferometer

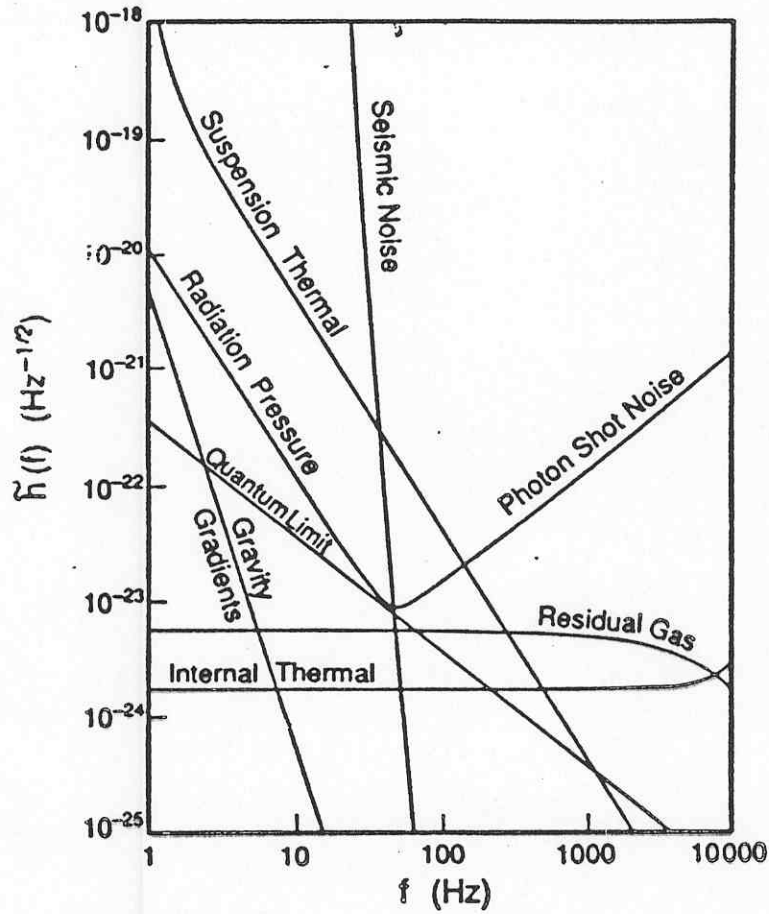

Advanced Interferometer

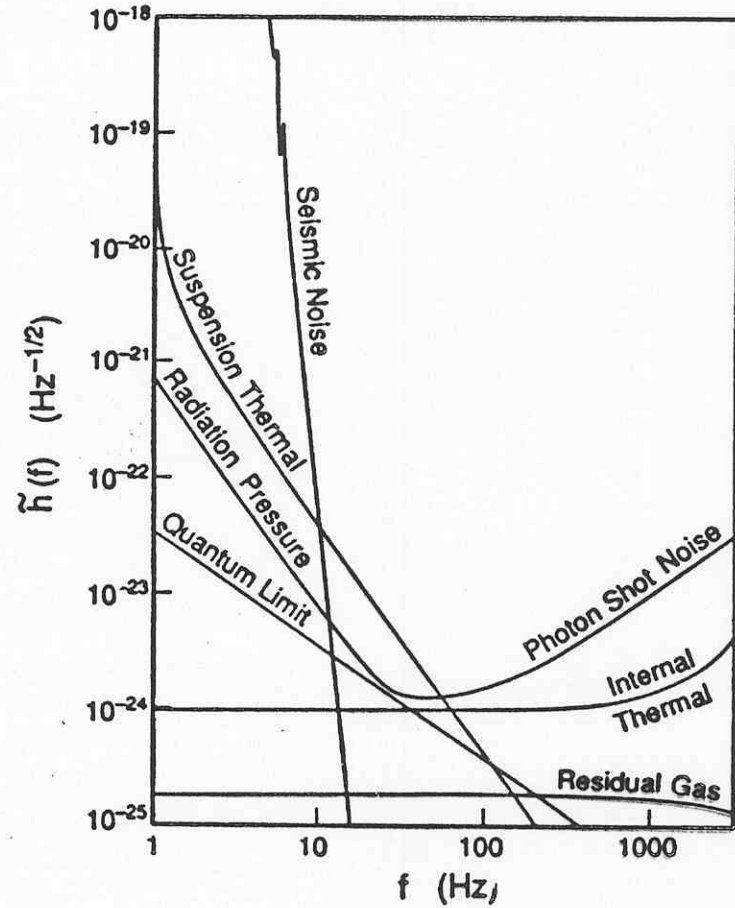

NEUTRON STAR BINARIES

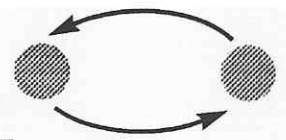

[“Near-Guaranteed” source]

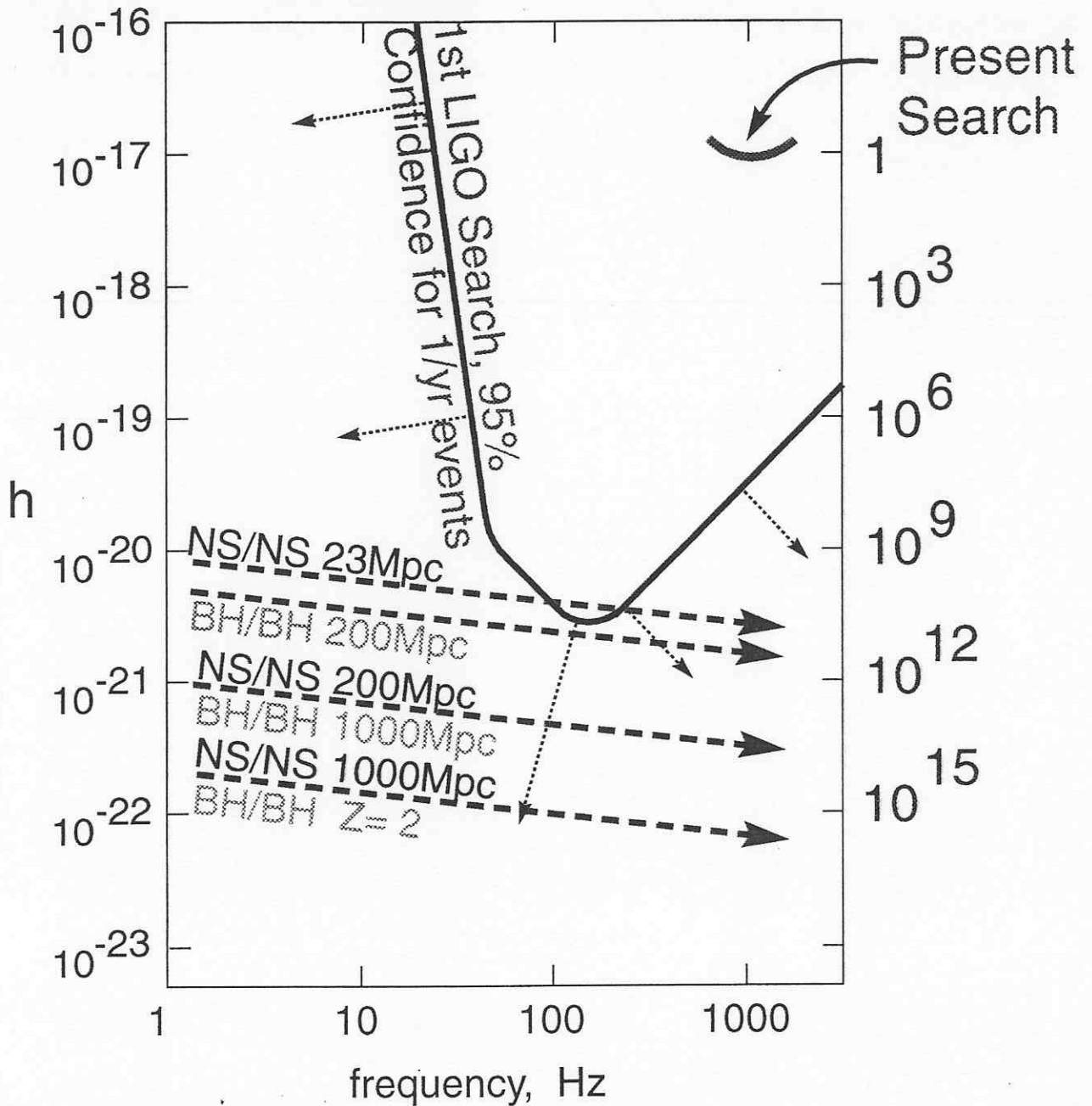

■ *15 minutes & 10,000 orbits in LIGO band*

■ *Rich information in waveforms:
masses, spins, distance, direction,
nuclear equation of state*

Conclusions

- LIGO Construction is well Underway
- Direct Detection of Gravitational Waves Appears Realistic within 10 years
- Ultimate Sensitivities Capable of Opening a New Field of Observational Astronomy with Gravitational Waves is the Long Term Goal.