

H1 Handle, 3"	E1 BNC lock washer	E13 BNC nut	PN2 Front Panel
H2 Handle, 3"	E2 BNC lock washer	E14 BNC nut	LIGO
Mouser 534-9109	E3 BNC lock washer	E15 BNC nut	D1102159-v1
H3 Ferrule	E4 BNC lock washer	E16 BNC nut	PN3 Rear Panel
H4 Ferrule	E5 BNC lock washer	E17 BNC nut	LIGO
H5 Ferrule	E6 BNC lock washer	E18 BNC nut	D1102160-v1
H6 Ferrule	E7 BNC lock washer	E19 BNC nut	PN4 DB37 cable
Mouser 534-9121	E8 BNC lock washer	E20 BNC nut	Digi-Key H7MMH-3706G-ND
M1 #6-32 3/8" flat	E9 BNC lock washer	E21 BNC nut	PN5 DB25cable
M2 #6-32 3/8" flat	E10 BNC lock washer	E22 BNC nut	PN6 DB25 cable
M3 #6-32 3/8" flat	E11 BNC lock washer	E23 BNC nut	Digi-Key H7MMH-2506G-ND
M4 #6-32 3/8" flat	E12 BNC lock washer	E24 BNC nut	
McMaster-Carr 91099A215	Newark 78M7215	Newark 78M7214	PN7 IDC header
			Newark 73K3943
			PN8 IDC header
			PN9 IDC header
			PN10 IDC header
			PN11 IDC header
			Newark 73K6217
H7 Standoff M-F	PN12 Banana jack	PN13 Banana jack	PN14 Jack screw
H8 Standoff M-F	Newark 39F1574	Newark 39F1575	PN15 Jack screw
H9 Standoff M-F			PN16 Jack screw
H10 Standoff M-F			PN17 Jack screw
H11 Standoff M-F			PN18 Jack screw
H12 Standoff M-F			Newark 80K5431
H13 Standoff M-F	H19 Standoff F-F	M5 M4-8mm, flat	M11 M4-8mm, flat
H14 Standoff M-F	H20 Standoff F-F	M6 M4-8mm, flat	M12 M4-8mm, flat
H15 Standoff M-F	H21 Standoff F-F	M7 M4-8mm, flat	M13 M4-8mm, flat
H16 Standoff M-F	H22 Standoff F-F	M8 M4-8mm, flat	M14 M4-8mm, flat
H17 Standoff M-F	H23 Standoff F-F	M9 M4-8mm, flat	M15 M4-8mm, flat
H18 Standoff M-F	H24 Standoff F-F	M10 M4-8mm, flat	M16 M4-8mm, flat
Newark 56K3066	Newark 56K3039		McMaster-Carr 91420A218

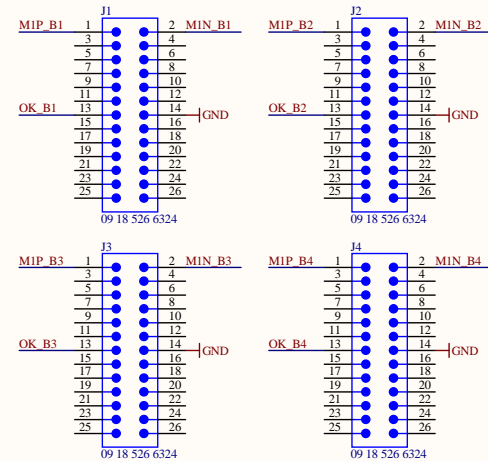
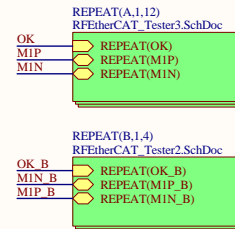
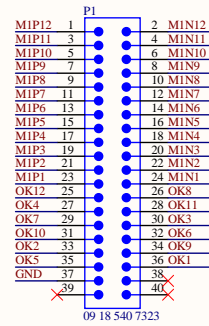

Title		
RF EtherCAT Tester1		
Size B	Number	Revision
	D1102085	v1
Date:	12/15/2011	Sheet 1 of 3
File:	C:\Users\...RFEtherCAT_Tester1.SchDoc	Drawn By: Paul Schwinberg

1

2

3

4

A

A

B

B

C

C

D

D

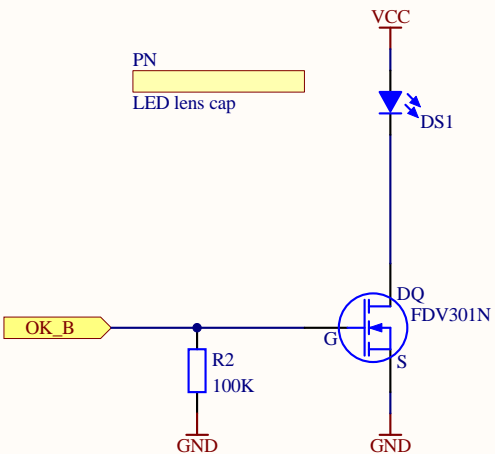
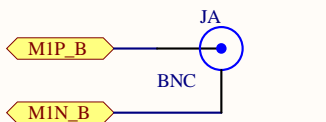

Title			RFEtherCAT Tester2		
Size	Number		Revision		
A	D1102085		v1		
Date:	12/15/2011		Sheet 2 of 3		
File:	C:\Users\...\RFEtherCAT_Tester2.SchDoc		Drawn By: Paul Schwinberg		

1

2

3

4

1

2

3

4

A

A

B

B

C

C

D

D

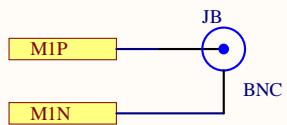
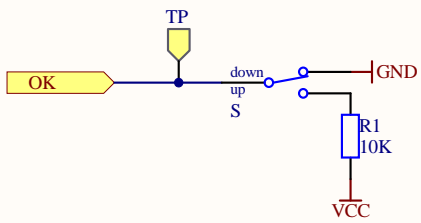

Title		
RFEtherCAT Tester3		
Size	Number	Revision
A	D1102085	v1
Date:	12/15/2011	Sheet 3 of 3
File:	C:\Users\...\RFEtherCAT_Tester3.SchDoc	Drawn By: Paul Schwinberg

1

2

3

4