

LIGO-D1201489-v3

LHO RF power budget 20/Mar/2013

by K.Izumi

v3 - The 9 and 45 MHz RF branches were newly measured and adjusted

RF power at most of the places in LHO were adjusted by inserting RF attenuators as shown in the subsequent pages. This document summarizes the recent measurement after the RF power adjustment at LHO.

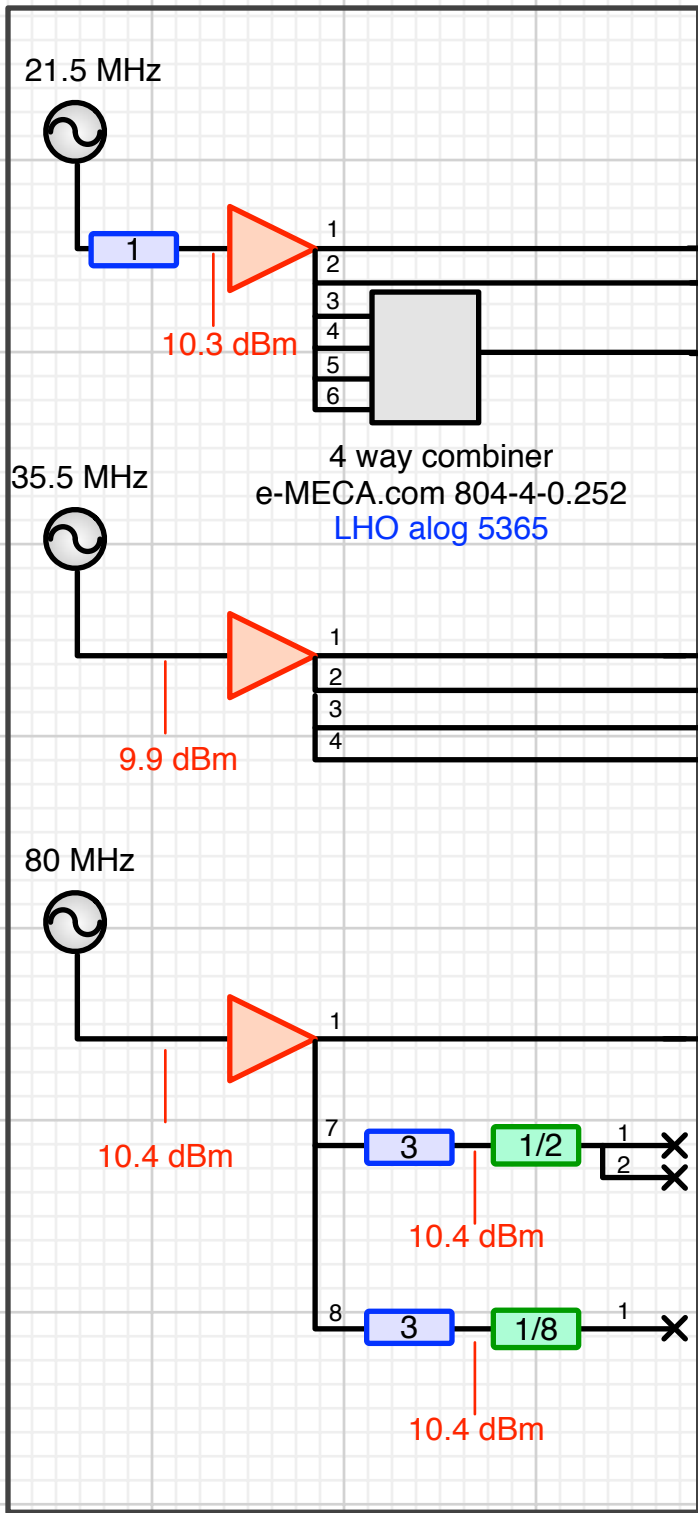

Remote Rack C3

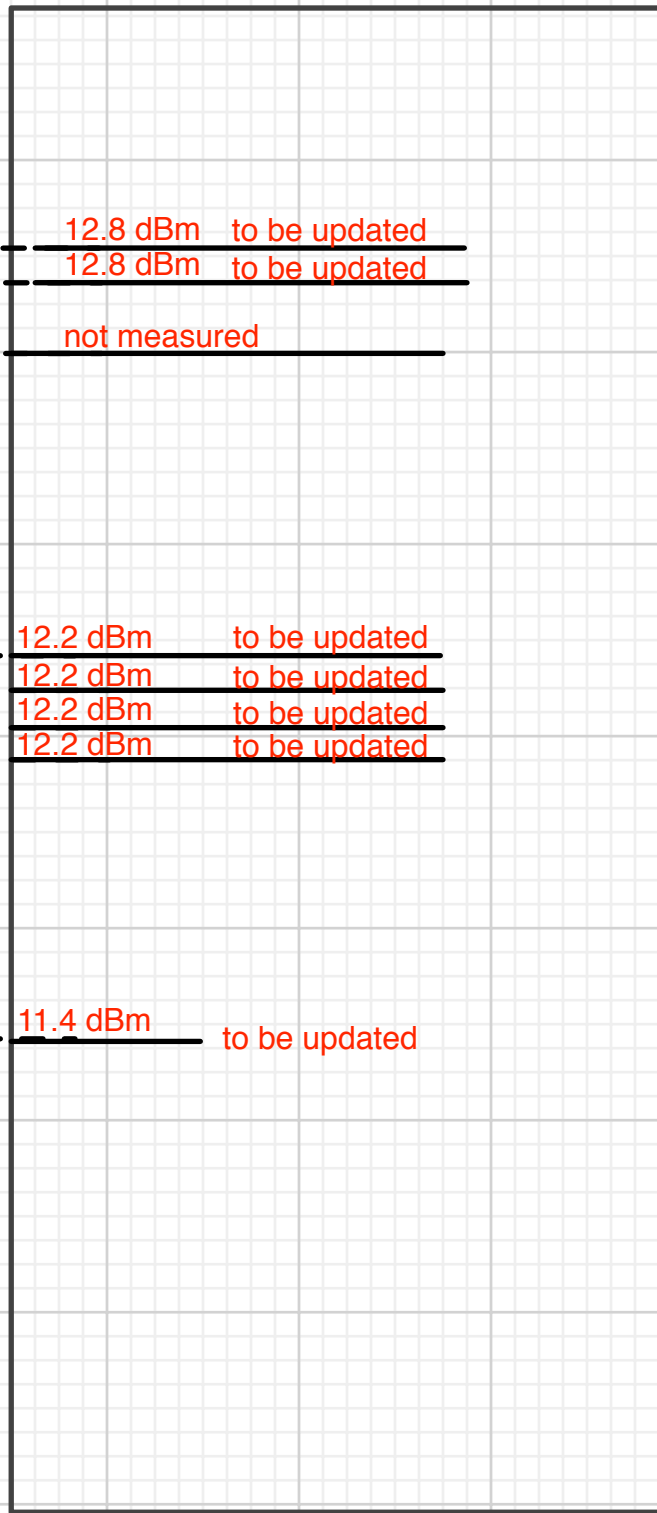

Field Rack PSL R1

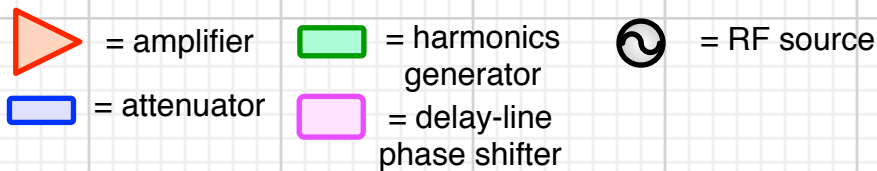

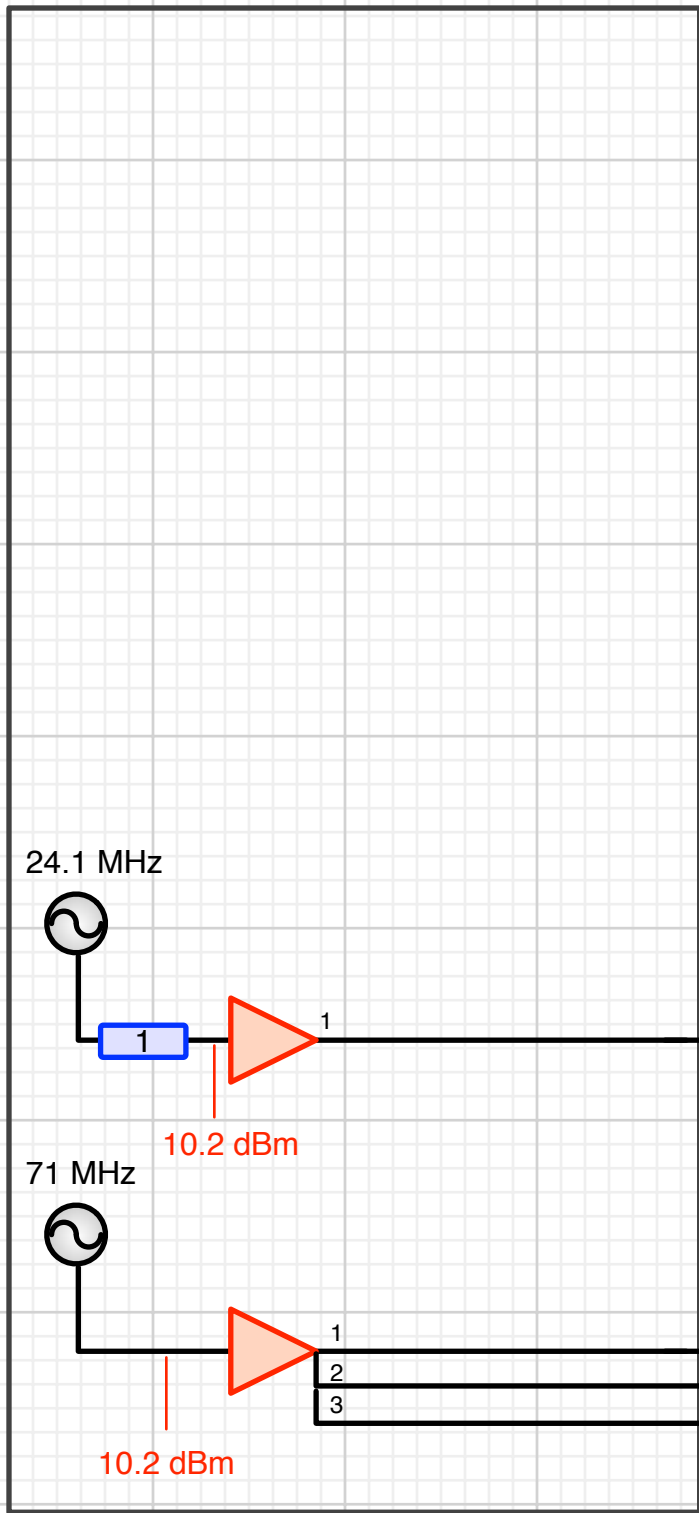

Remote Rack C4

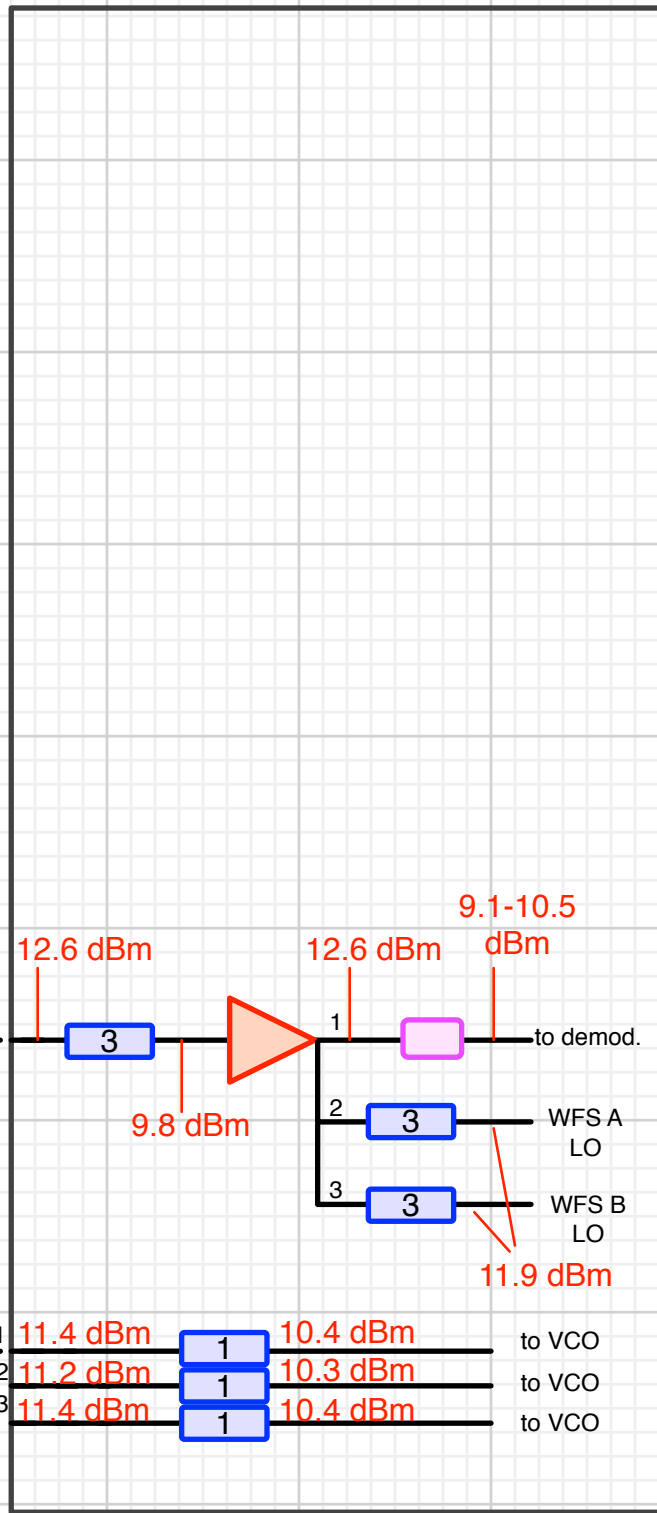

Field Rack ISC R1

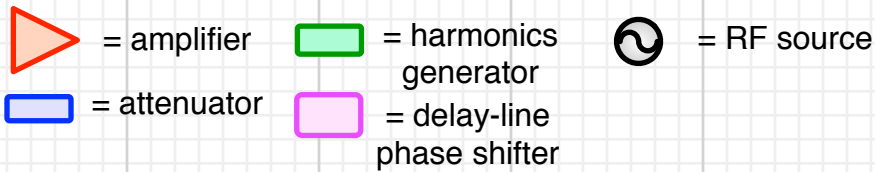

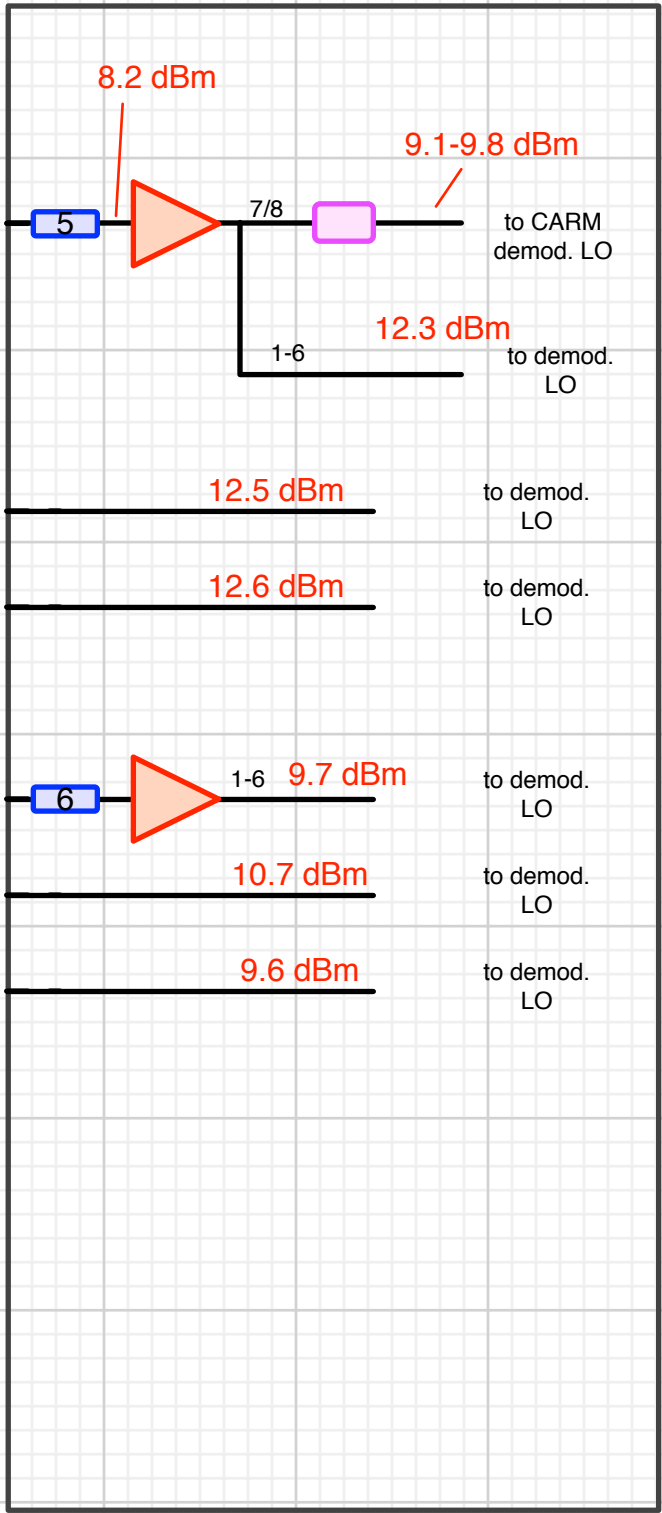
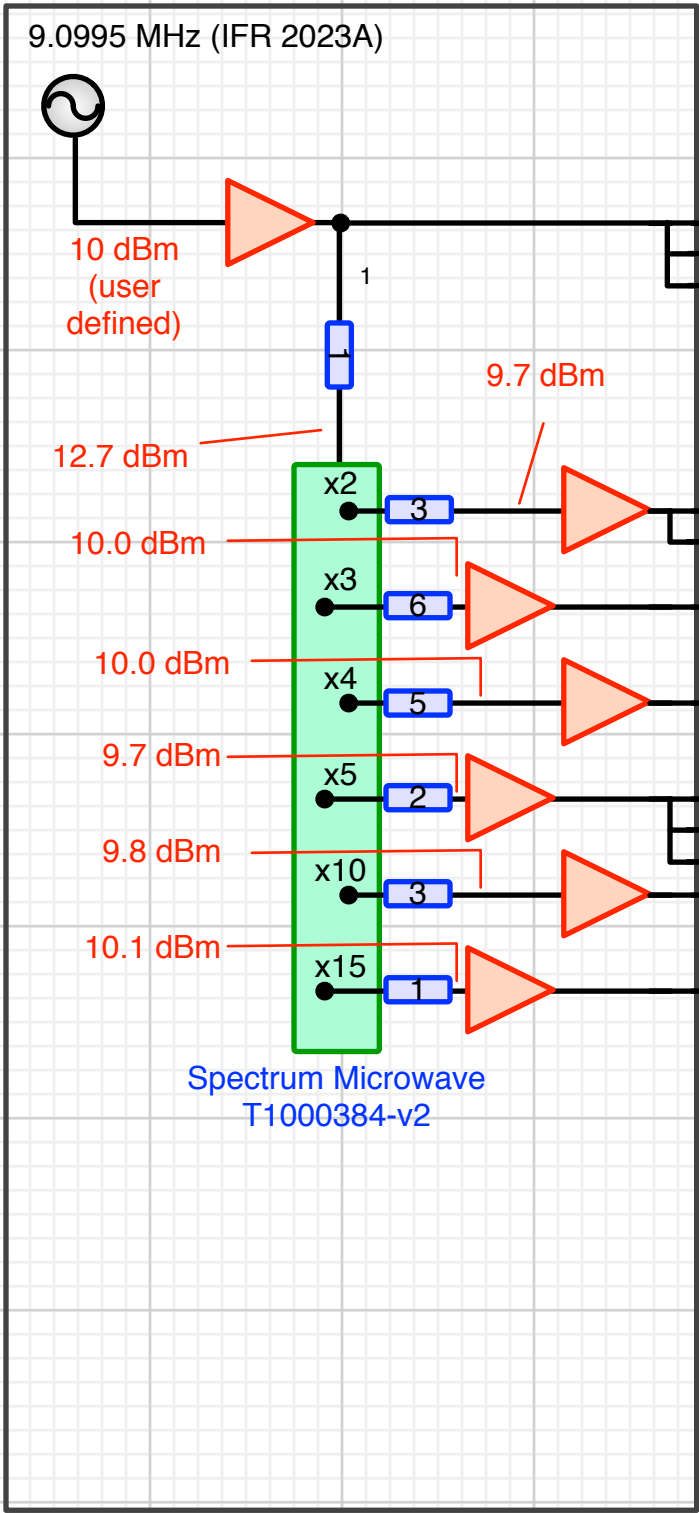

Remote Rack C4

Field Rack ISC R1

- = amplifier
- = attenuator
- = harmonics generator
- = delay-line phase shifter
- = RF source