

Squeezed quadrature fluctuations in a gravitational wave interferometer

S Dwyer, L Barsotti, SSY Chua, M Evans, M Factourovich, D Gustafson, T Isogai, K Kawabe, A Khalaidovski, PK Lam, M Landry, N Mavalvala, D E McClelland, G D Meadors, C M Mow-Lowry, R Schnabel, RMS Schofield, N Smith-Lefebvre, M Stefszky, C Vorvick and D Sigg.

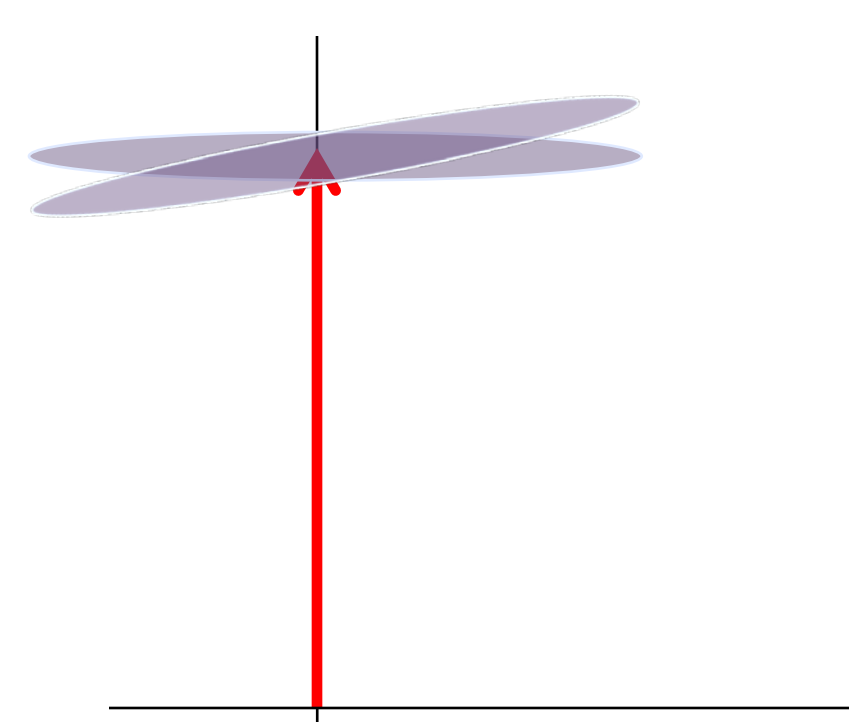

To get the full benefit of squeezing in an interferometer the squeezing angle must be maintained so that the measurement quadrature has reduced noise.

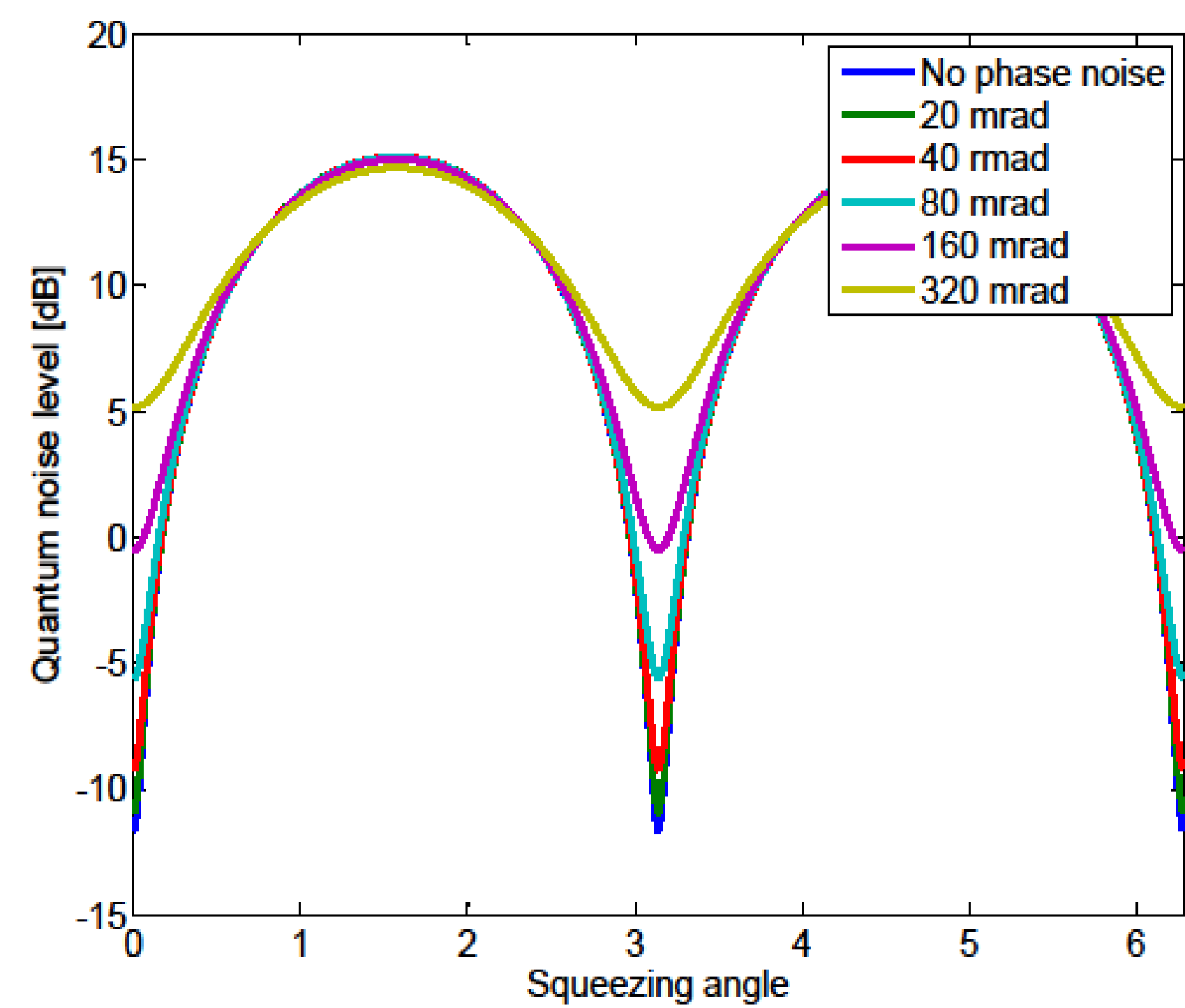

Squeezing angle fluctuations increase broadband the level of quantum noise. The long term stability of the squeezing angle limits the stability of squeezing.

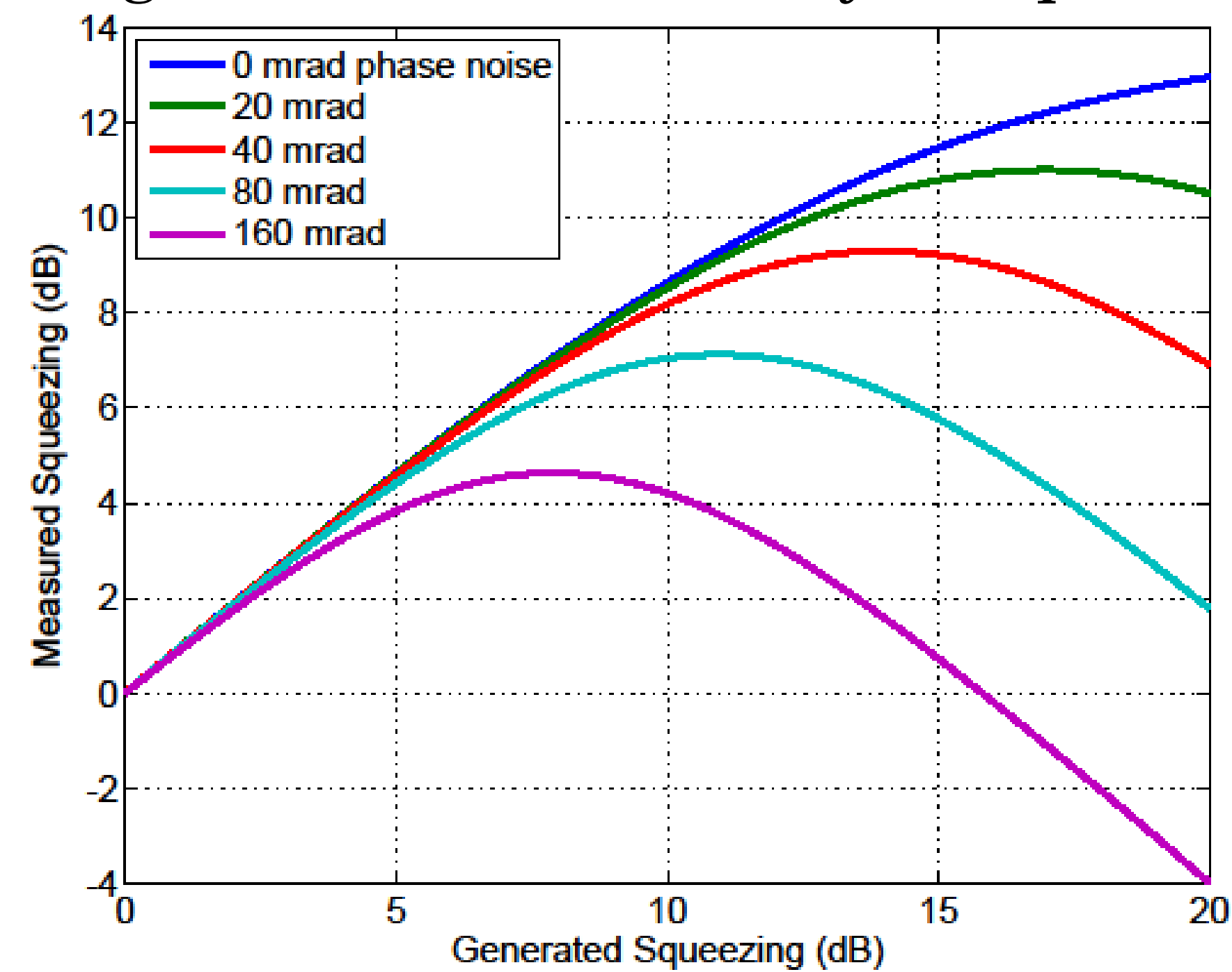

The effect of squeezing angle fluctuations on the level of squeezing becomes more important as the level of squeezing increases.

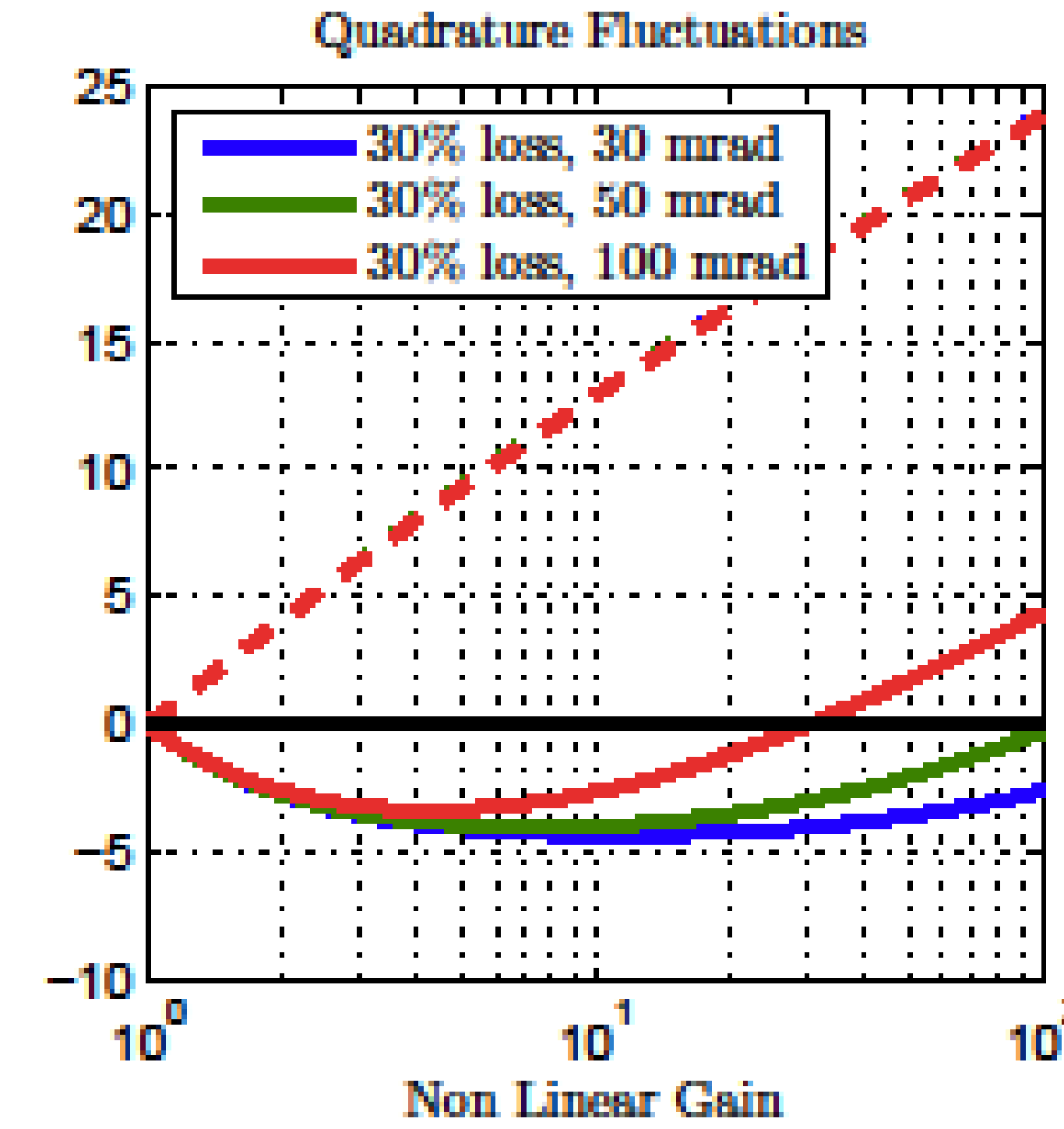
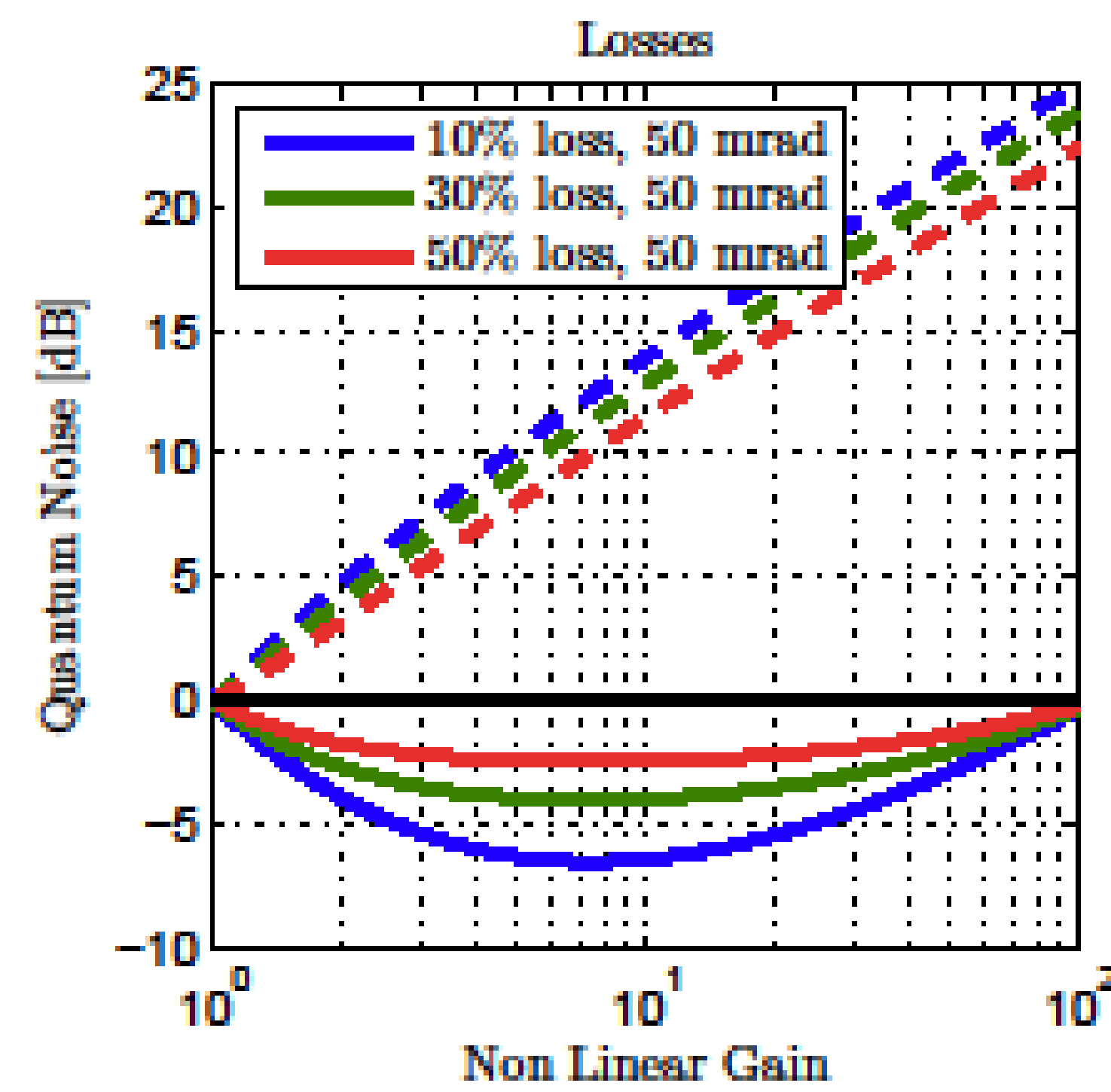

The impact of squeezing angle fluctuations, optical losses, and technical noise on the level of observed squeezing can be distinguished by measuring both anti-squeezing and squeezing at different levels of nonlinear gain.

The lock point of the squeezing angle control loop varies with interferometer alignment, so that alignment jitter couples to squeezing angle fluctuations. This coupling can be minimized when the alignment between the squeezed beam and the interferometer beam is optimized, as shown by the black and green points in this plot.

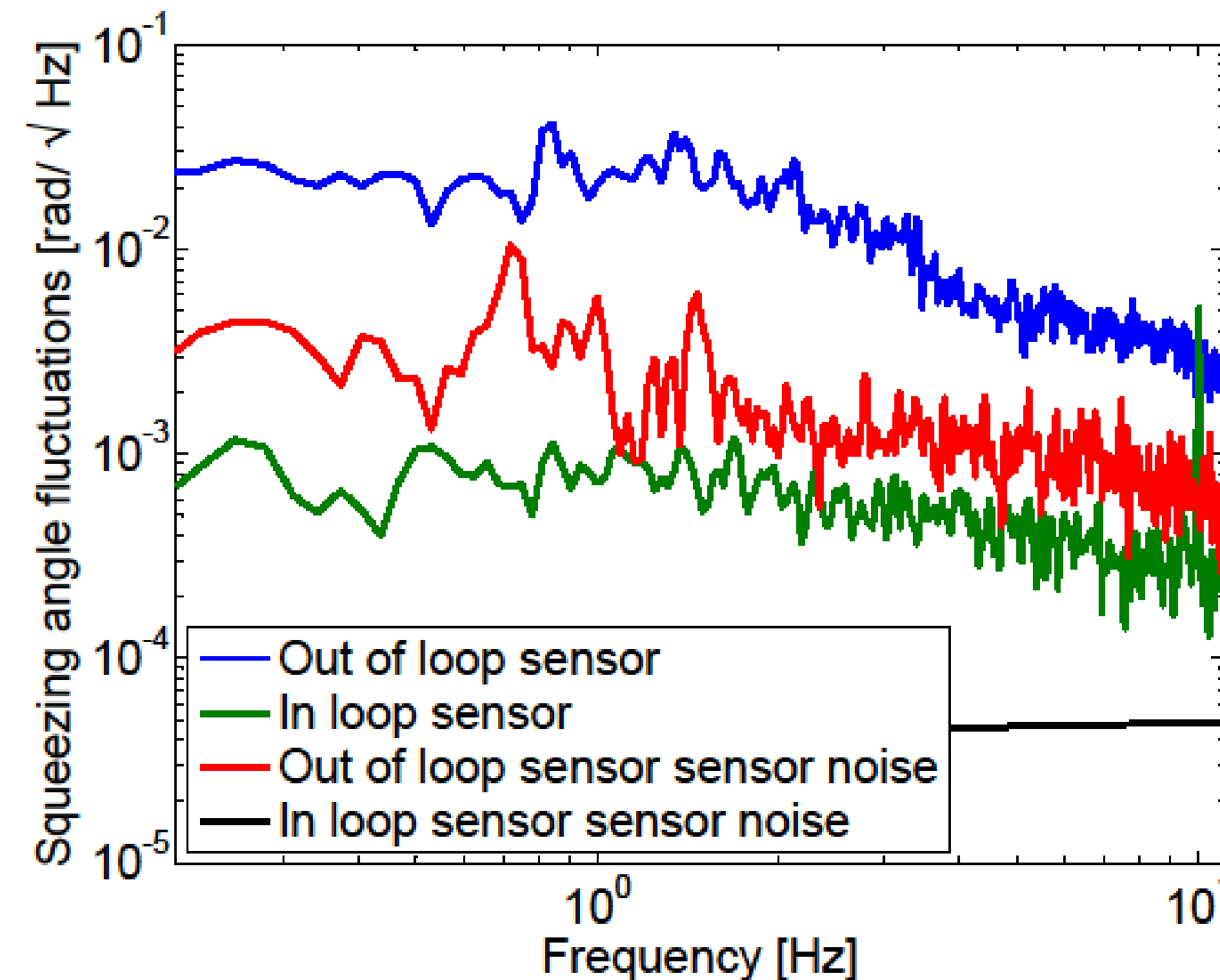

A direct measurement of the squeezing angle fluctuations can be made by rotating the squeezing angle to a point where the shot noise level has a linear dependence on the squeezing angle, and making a spectrum of the band limited RMS noise at a frequency that is limited by quantum noise. This measurement showed that lock point errors at low frequencies dominated the squeezing angle fluctuations.

A coherent control field injected into the OPO undergoes a nonlinear interaction. This field is sensed in the interferometer where its phase is used as a proxy for the squeezing angle. Chelkowski PRA 75, 043814 (2007).

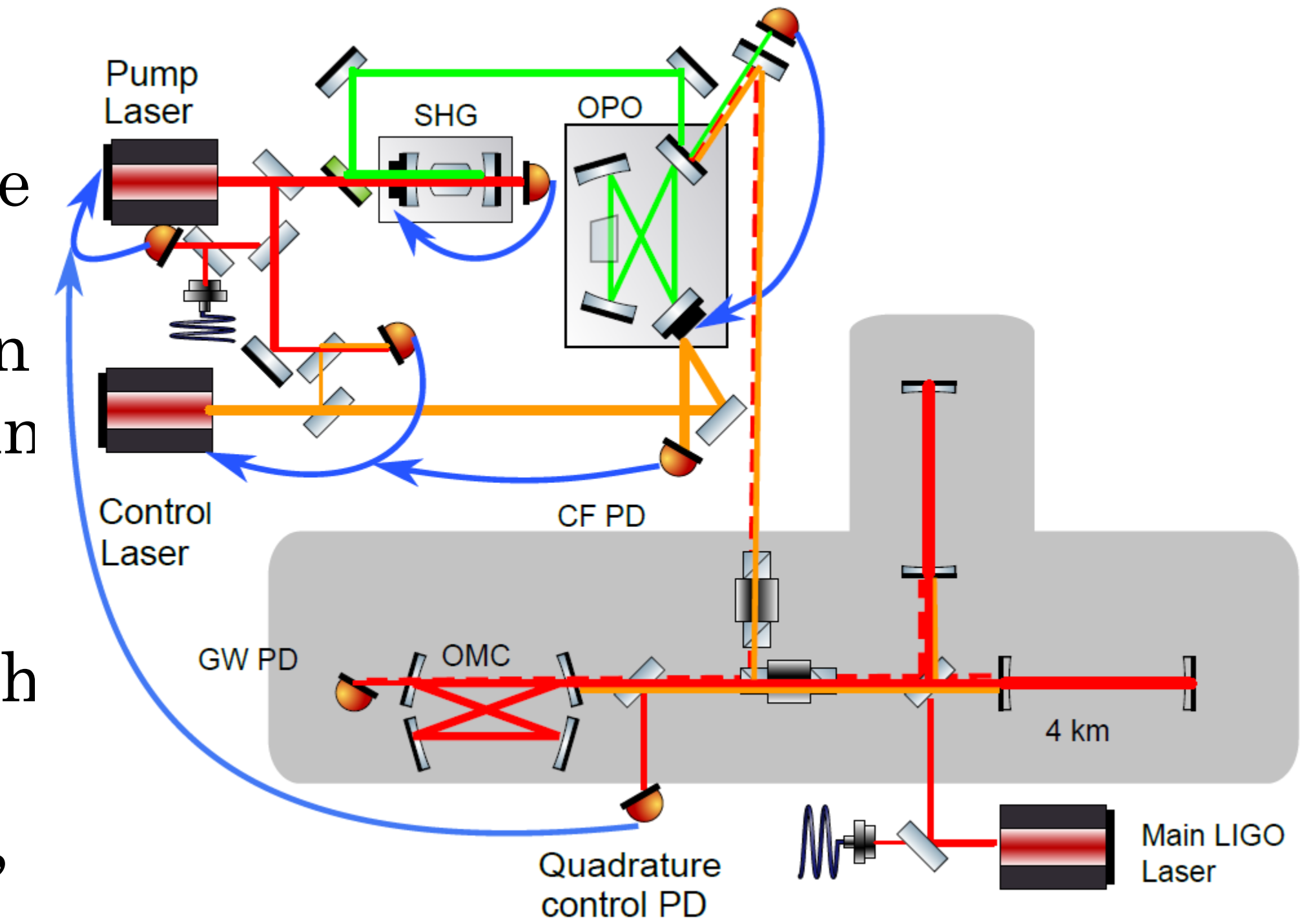

This controls scheme corrects for fluctuations of the pump phase, path length changes, and phase noise of the local oscillator.

Errors in the OPO length and the temperature of the nonlinear crystal also cause squeezing angle shifts, which are not corrected completely by the control scheme.

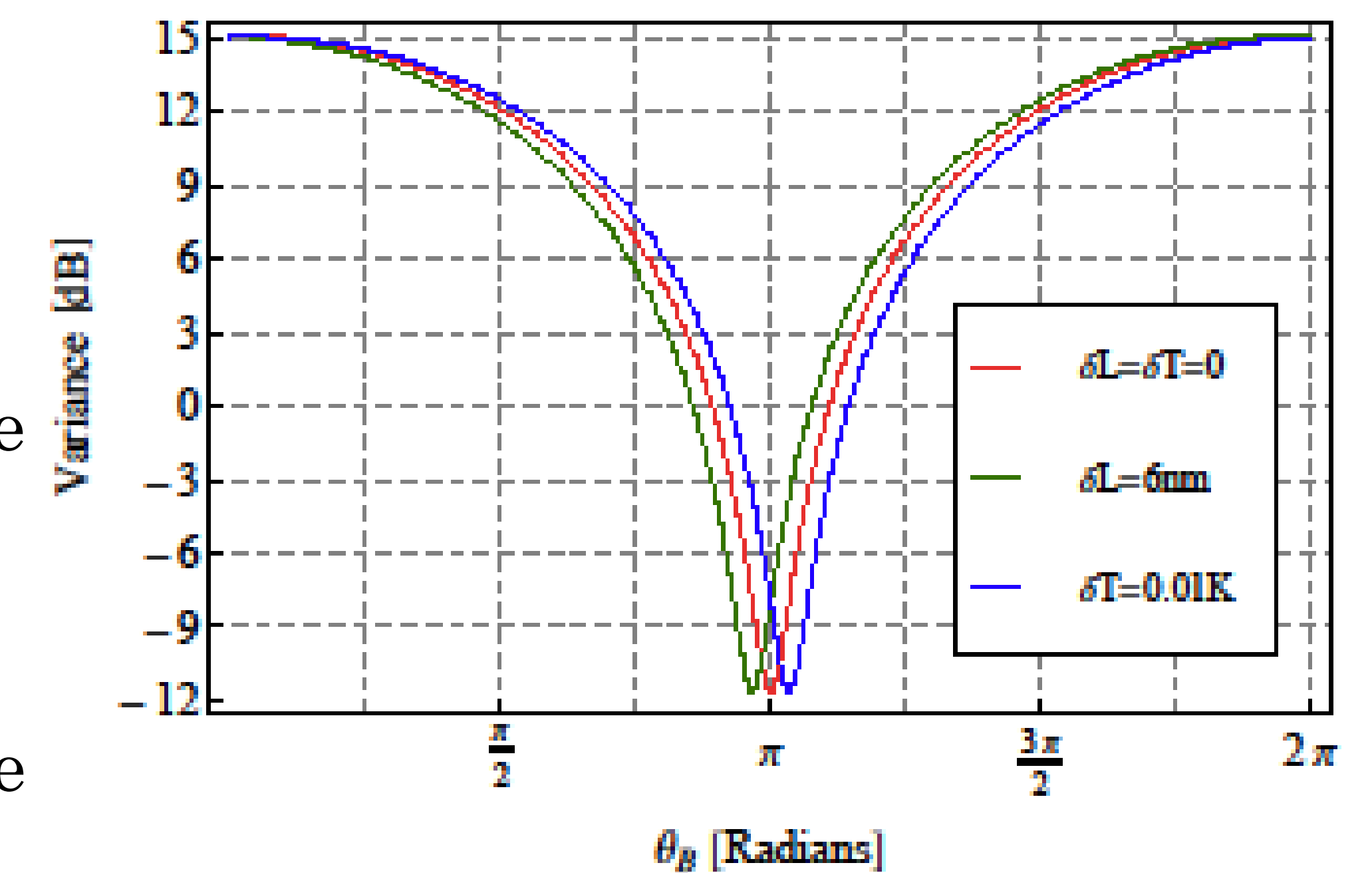

The level of squeezing that can be measured in an interferometer is determined by the level of optical losses and squeezing angle fluctuations. Squeezing angle fluctuations will become more important as losses are reduced.

