



LASER INTERFEROMETER GRAVITATIONAL WAVE OBSERVATORY

*LIGO Laboratory / LIGO Scientific Collaboration*

LIGO-M1500313-v2

*LIGO*

24 Dec 2015

---

Process Flow for Engineering Operations  
of the LIGO Detector Systems

---

Dennis Coyne, Richard Oram, Jeff Kissel

Distribution of this document:  
LIGO Scientific Collaboration

This is an internal working note  
of the LIGO Laboratory.

California Institute of Technology  
LIGO Project

Massachusetts Institute of Technology  
LIGO Project

LIGO Hanford Observatory

LIGO Livingston Observatory

<http://www.ligo.caltech.edu/>

# 1 Contents

<b>2</b>	<b><i>Purpose</i></b> .....	<b>3</b>
<b>3</b>	<b><i>Scope</i></b> .....	<b>3</b>
<b>4</b>	<b><i>Sub-Processes and Precedence</i></b> .....	<b>3</b>
<b>5</b>	<b><i>Top Level Summary</i></b> .....	<b>5</b>
<b>6</b>	<b><i>Process Diagrams for each Event</i></b> .....	<b>8</b>
<b>7</b>	<b><i>BPMN Synopsis</i></b> .....	<b>18</b>

## 2 Purpose

The purpose of this memo is to define the process flow for engineering operations of the LIGO detector systems.

## 3 Scope

The scope is limited to:

- a) Processes associated with the engineering and operation of the LIGO detector systems, including the facilities that support the detector system.

The scope does not include processes specifically related to:

- a) Instrument or astrophysics science or research<sup>1</sup>,
- b) Data analysis of detector data,
- c) Business functions such as procurement, budgeting, expense accounting, etc.
- d) Safety,
- e) Inventory control,
- f) Sparing,
- g) Problem/dispute resolution, and
- h) Customer reporting processes/functions.

In addition, the document does not address the detailed procedures to implement the processes discussed herein; these procedures are covered in referenced documents.

## 4 Sub-Processes and Precedence

This document starts with initiating events (or “use cases”) and addresses the required process flow, and the relationship of established existing processes. The following table lists the sub-processes which are referred to within this document. The references for these processes (also included in the table) take precedence over this document with regard to the details and implementation of these sub-processes.

**Table 1 Sub-Process List for LIGO Lab Engineering Operations**

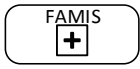

Process	Description	Reference
	<u>aLOG</u> : The advanced LIGO electronic logbook is used to report all observatory activities which effect the detector system.	<a href="#">M1500258</a> <a href="#">T000037</a> LHO aLOG LLO aLOG
	Preventive Maintenance. <u>FAMIS</u> is a software package <sup>2</sup> , used to organize the management of Preventive	<a href="#">G1500826</a> LLO FAMIS URL:

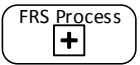
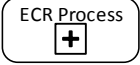
<sup>1</sup> However, the later phases of development in R&D efforts which result in upgrades to, or changes in, the detector systems are covered in this document, and the design review process described in M1500263.

Process	Description	Reference
	<p>Maintenance (PM) at the LIGO sites:</p> <ul style="list-style-type: none"> <li>a) LLO/LHO assets to be maintained are identified in FAMIS.</li> <li>b) Written procedures for the specific PMs are developed</li> <li>c) The routine PMs of the assets are scheduled in advance and work orders are generated to the assignees</li> <li>d) Work order execution and completion is tracked in real-time.</li> <li>e) Key Performance Indicator metrics on the Preventive Maintenance activities are generated.</li> </ul>	<p>?</p> <p>LHO FAMIS URL: ?</p>
	<p>Corrective Maintenance: Fault Report and Service (<u>FRS</u>) is a software tool<sup>3</sup> used to organize the management of Corrective Maintenance (CM) at the LIGO sites. The overarching goal is to make the FRS useful both for documenting, prioritizing and fixing problems, providing troubleshooting and resolution information, and for tracking time loss, performance statistics, and systematic failure behavior.</p> <p>Open FRs are used to direct operations work on a daily and weekly basis, and communicate status of newly occurring problems. FRs are <b>not</b> the means for scheduling or tracking long term work, or maintaining lists of unfixed problems. <u>The life cycle of an open FR is short</u>. If the FR is not being worked on, it should not be open. When more FRs are open than it is possible to work on, the open status of an FR loses meaning and unclosed FRs pile up.</p> <p>Upon review, long-term fix issues, investigations, redesign will be escalated to the Integration Issue &amp; ECR Tracker tool.</p>	<p><a href="#">T1400332</a></p> <p><a href="#">G1500826</a></p> <p><u>LLO FRS link:</u> <a href="https://services.ligo-la.caltech.edu/FRS/">https://services.ligo-la.caltech.edu/FRS/</a></p> <p><u>LHO FRS link:</u> pending</p>
	<p><u>Engineering Change Request (ECR)</u>: The purpose of the ECR is to request and get approval for a proposed change(s). The scope of the ECR process is the design of the system, not its operational settings or parameters. All design aspects of the LIGO System are under ECR control.</p>	<p><a href="#">M1200274</a></p>

<sup>2</sup> FAMIS is a facility management software package: <http://www.accruent.com/products/famis>

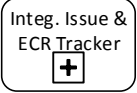
<sup>3</sup> FRS is a modification/customization of the Bugzilla software tool, and can be found at this URL: <https://services.ligo-la.caltech.edu/FRS/>

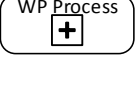
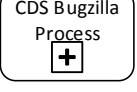
Process	Description	Reference
	<p><u>Integration Issue and ECR Tracker</u>: A planning and reporting/tracking tool to track issues that arise during installation, integration, commissioning and operation. Due to the fact that resolution of these issues sometimes involves making changes to the design, we have also chosen to track Engineering Change Requests (ECRs) with the same instance of Bugzilla<sup>4</sup>. The scope for this issue tracking and resolution system is hardware or system/subsystem issues and ECRs for the LIGO Observatory science instrument, aka the interferometer (IFO) system, including the vacuum system.</p>	<p><a href="#">M1300323</a>  <a href="#">Issue &amp; ECR Tracker:</a>  <a href="https://services.ligo-wa.caltech.edu/integrationissues/">https://services.ligo-wa.caltech.edu/integrationissues/</a></p>
	<p><u>Design Review Process</u>: Programmatic guidelines for the development phases of proposed upgrades to the advanced LIGO (aLIGO) detector from the requirements and conceptual design phase through fabrication. Includes OMT review &amp; approval for funding upgrades.</p>	<p><a href="#">M1500263</a>  <a href="#">M1500262</a></p>
	<p><u>Work Permit (WP) process</u>: A work permit is required for tasks that may impact others or affect the performance of the detectors. A task can be detector, vacuum or facilities related. Work permits tell us what is going on, who is doing it, and for how long it might last.</p>	<p><a href="#">M1100264</a>  <a href="#">M050194</a>  <a href="#">LLO work permits</a>  <a href="#">LHO work permits</a></p>
	<p><u>CDS Bugzilla</u>: Software ‘bugs’ and feature/improvement requests (principally for the DAQ/CDS system) are reported and tracked to resolution in this instance of Bugzilla.</p>	<p><a href="#">CDS Bugzilla:</a>  <a href="https://bugzilla.ligo-wa.caltech.edu/bugzilla3/">https://bugzilla.ligo-wa.caltech.edu/bugzilla3/</a></p>

## 5 Top Level Summary

A top-level, or summary, process diagram<sup>5</sup> (Figure 1) indicates four primary process paths which are triggered by “starting events” or conditions:

- 1) Preventive Maintenance (PM) path (Typically routine and scheduled task)
- 2) Corrective Maintenance (CM) path (Typically non-routine and unscheduled tasks)
- 3) Duty Cycle Reporting path
- 4) Design Change Path

Nuances and off-nominal (or unusual conditions and exceptions) are purposely not shown in this simplified diagram.

<sup>4</sup> Bugzilla is a web-based general-purpose bug tracker and testing tool originally developed and used by the Mozilla project, and licensed under the Mozilla Public License.

<sup>5</sup> See section 7 for process diagram nomenclature.

Which path, tool or process is used for a “problem” depends upon the nature of the problem:

- 1) A “problem” (fault, failure, bug, etc.) which directly results in detector system downtime is always reported in FRS. Generally (though potentially not always) the resolution of the FRS “problem” is a corrective maintenance (CM) activity.
- 2) Software faults (commonly referred to as “bugs”) or software feature/change requests which have not directly resulted in detector system downtime, are reported in the CDS Bugzilla tool/process.
- 3) All other types of “problems”, referred to as “issues”, generally involve more than just software (at least in their interfaces, or impact) or require longer term resolution (research/investigation and/or re-design).

When a “problem” is first reported, the nature of the ultimate resolution may not be known, or even suspected. In this case it should be reported in FRS. If it is later found to require deep investigation or re-design, then it will be “transferred” from FRS to the Issue & ECR Tracker, or to the CDS Bugzilla tool.

As indicated in the simplified process diagram (Figure 1), there are three basic types of initiating events:

- 1) Preventative Maintenance (PM) which paths through FAMIS and the WP process
- 2) “Problems” (Faults, Failures, Issues and Re-Designs) which path through one of the three problem resolution tools (FRS, CDS Bugzilla or the Integration Issue and ECR Tracker) and the WP process. Additionally design changes go through the ECR process, and the Design Review process. Note that by default reports are to be made into FRS; Only if one is sure that the “problem” is most appropriate to the Integration Issue & ECR Tracker or the CSD Bugzilla tool, should one not enter the report into FRS.
- 3) Lockloss events and IFO downtime (e.g earthquake, environmental, wind, seismic) which are captured by operators using the MEDM interface, as well as automated tools (Guardian and Detchar summaries). NOTE: Any Observing Time Loss (OTL) due to a HW/SW fault, procedural error or power glitch must trigger an FRS entry, the corrective maintenance process and the OTL recorded.

There are two decision points in the process flow path for “problems” (◆ and ◆ in Figure 1) which can be somewhat perplexing to navigate:

- 1) ◆ Depending on the nature of the “problem”, it is to be reported, and tracked to resolution, by either the FRS tool/process, the CDS Bugzilla tool/process or the Integration Issue & ECR Tracker tool/process. By default (i.e. if in doubt), problems are to be reported in FRS.
- 2) ◆ Design changes must go through the ECR process (except for changes explicitly excluded by the ECR scope; see [M1200274](#)). By default (i.e. if in doubt) prepare an ECR for review and approval.

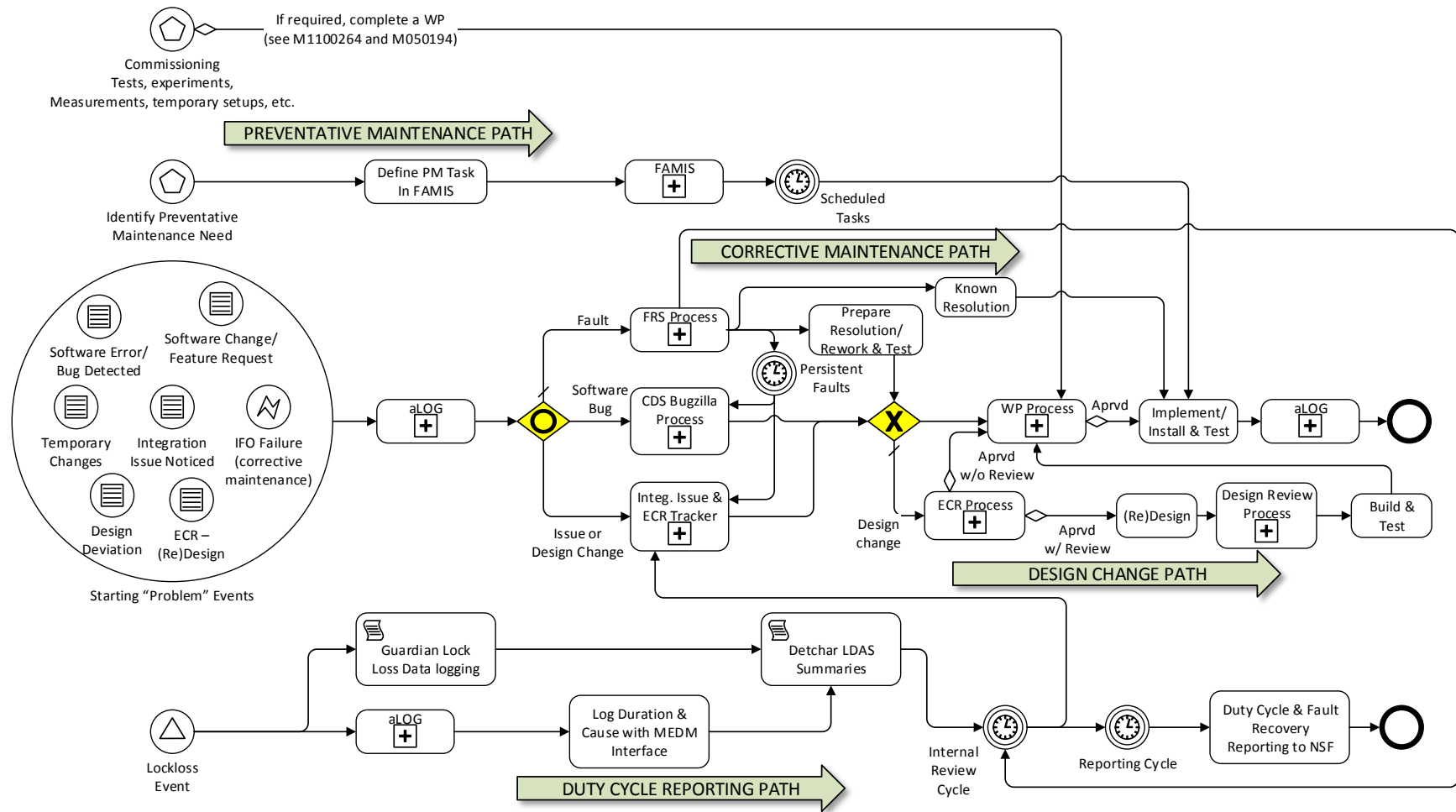











Figure 1 Process Diagram: Simplified (first order) Process Diagram for all Events

## 6 Process Diagrams for each Event

The list of process starting events is given in Table 2.

**Table 2 List of Process Starting Events**





Event	Description
 Identify Preventative Maintenance Need	A preventative maintenance task or procedure is identified, or scheduled.
 Lockloss Event	The detector loses interferometric lock due to known or unknown causes. The cause can be either external (e.g. environmental) or internal (e.g. detector parameter change or component failure).
 Software Error/ Bug Detected	A software error (aka bug), or feature, or desired change, in some component of the detector software, is identified. This event may (or may not) be triggered by, or associated with, a specific detector fault, or a lock-loss event. A technical staff member (typically an operator, a detector group member, a commissioning group member, or an LSC colleague) initiates these events.
 Software Change/ Feature Request	
 Temporary Changes	A temporary change (generally an experiment during commissioning) is made; see section 3.7, “Field Changes” in <a href="#">M1200274-v4</a> , “ECR Process”.
 Integration Issue Noticed	A system-level, or integration, issue is recognized or discovered.
 IFO Failure (corrective maintenance)	A failure of a detector (interferometer) hardware component occurs.
 Design Deviation	A deviation from the design is discovered (either intentional or unintentional). Requires a waiver review. See also the Waiver Log at <a href="#">E1500147</a> , and the <a href="#">Waivers in the Integration and ECR Tracker</a>
 ECR – (Re)Design	A design change is requested/proposed. Requires an Engineering Change Request (ECR).

The simplified, top-level process diagram (Figure 1), together with a basic understanding of the intent of these processes, may suffice for most users. However, detailed process diagrams have also been created for each of the “starting events” (aka “use cases”) shown in Table 2. It is important to note that a real event can result in more than one “process starting event”; for example, consider the



following case: a fault occurs which causes the detector (interferometer) to lose lock. As shown in Table 3, several process starting events may result from this one real event.

**Table 3 Hypothetical Real Event: A detector Fault, may result in a series of “Process Starting Events”**

Process Starting Event	Description
 Lockloss Event	1) A lock loss event has occurred. An aLOG entry is made.
 IFO Failure (corrective maintenance)	2) The fault is found to be due to a detector component failure. An FRS entry is made (and cross-referenced to the aLog entry). Corrective Maintenance is performed for the failed component and the FRS entry is closed.
 Integration Issue Noticed	3) Triggered by this failure, it is realized that a longer term issue exists. Either simultaneously, or subsequently, an “Integration Issue & ECR Tracker” entry is created (and cross-referenced to the FRS entry).
 ECR – (Re)Design	4) Later as the issue is investigated we realize that this should be addressed with a design change, i.e. an ECR; The “Integration Issue & ECR Tracker” entry is switched to ECR type, and an ECR is prepared for review and approval.

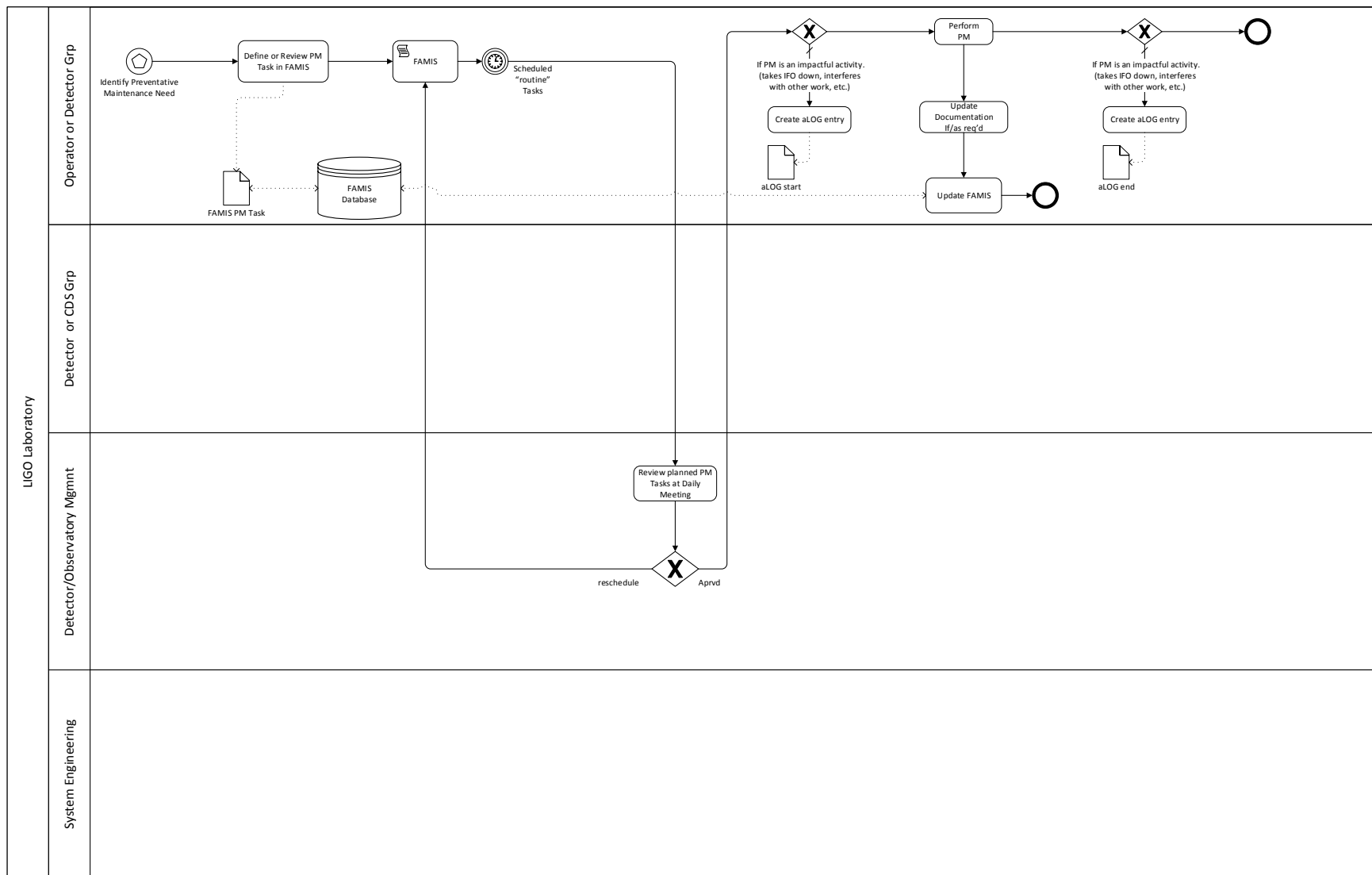

Figure 2 Process Diagram: Preventative Maintenance (PM)

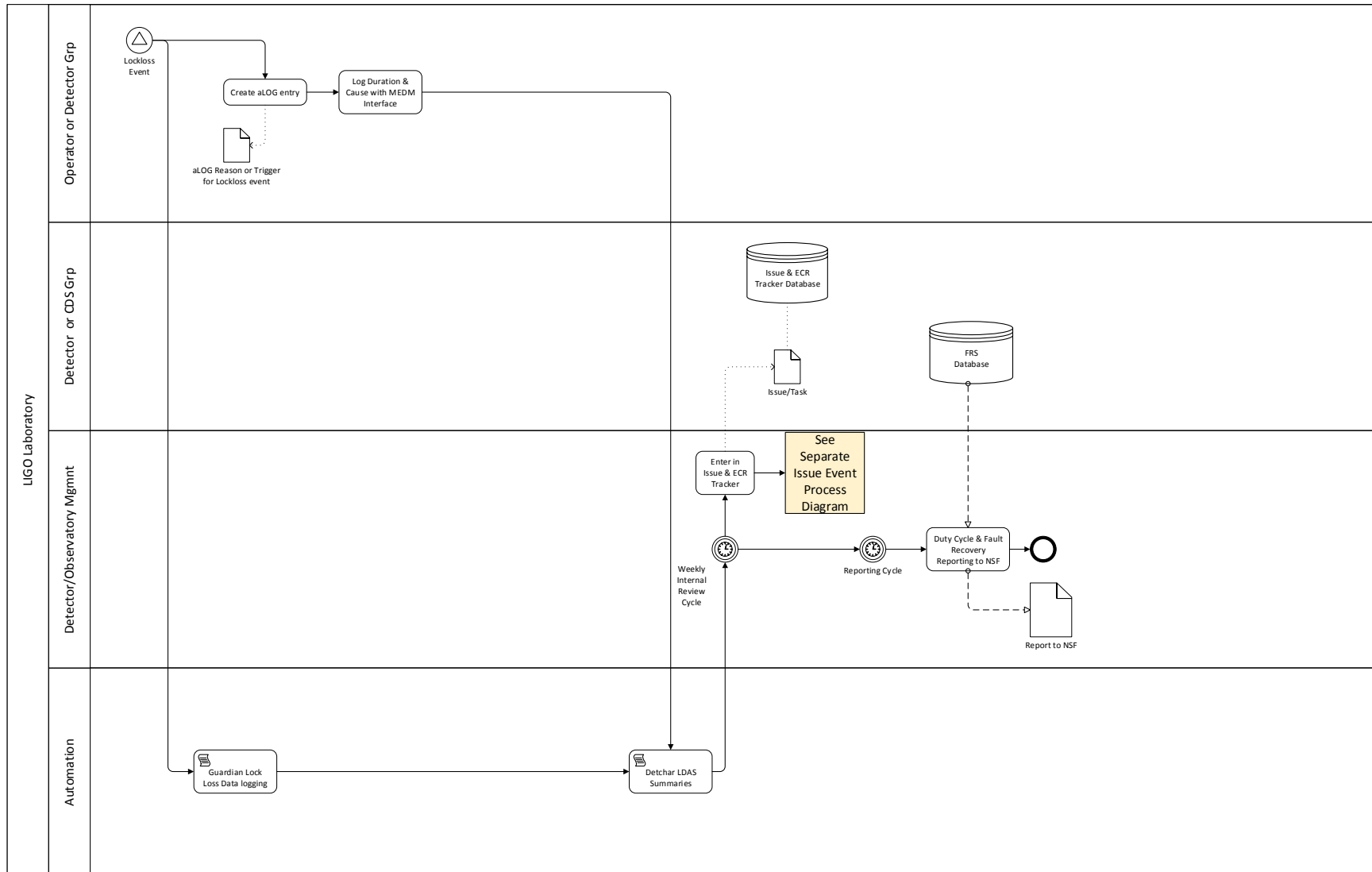

Figure 3 Process Diagram: Lock Loss Event

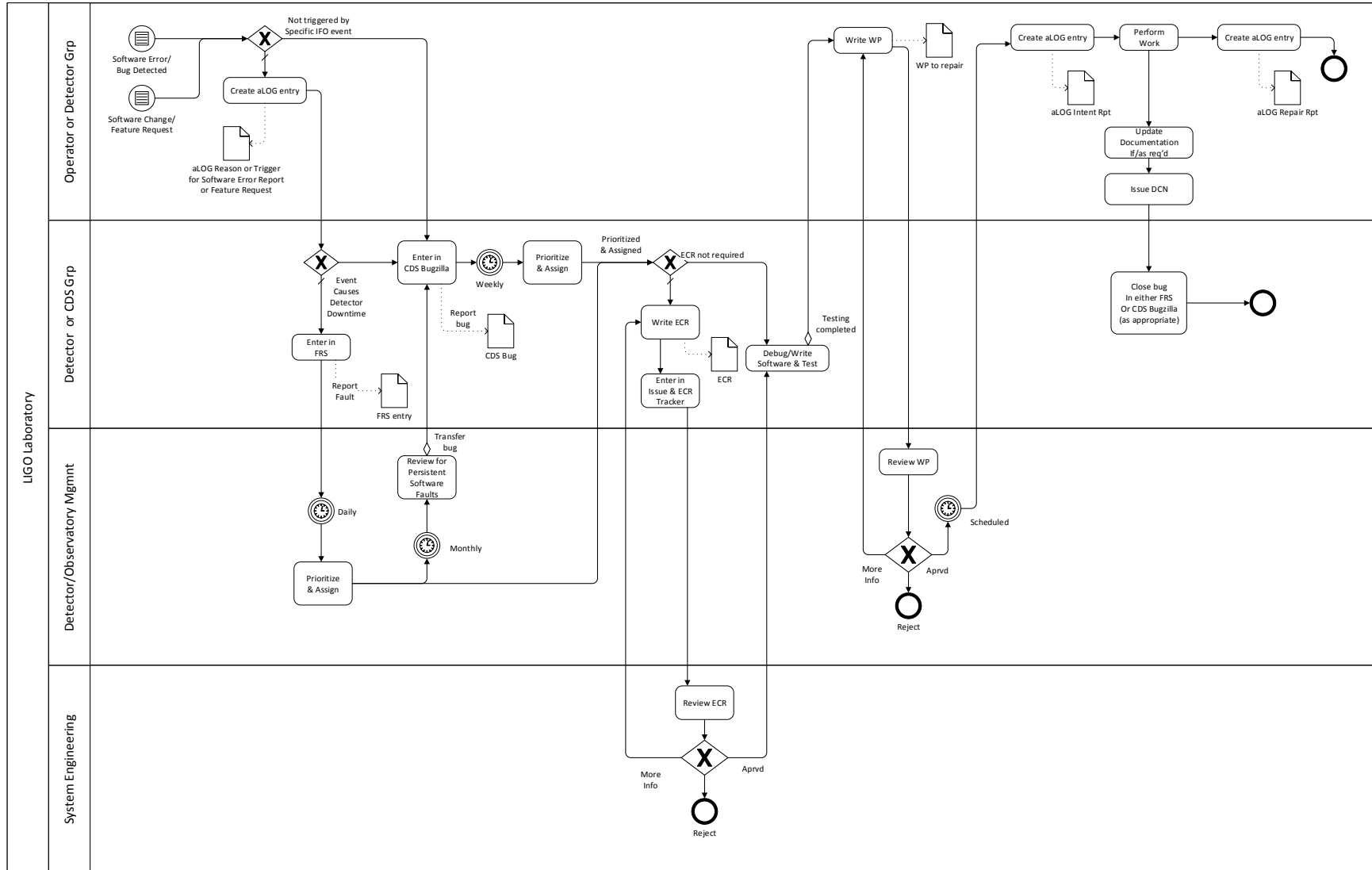

Figure 4 Process Diagram: Software Bug Detected or Software Feature/Change Requested

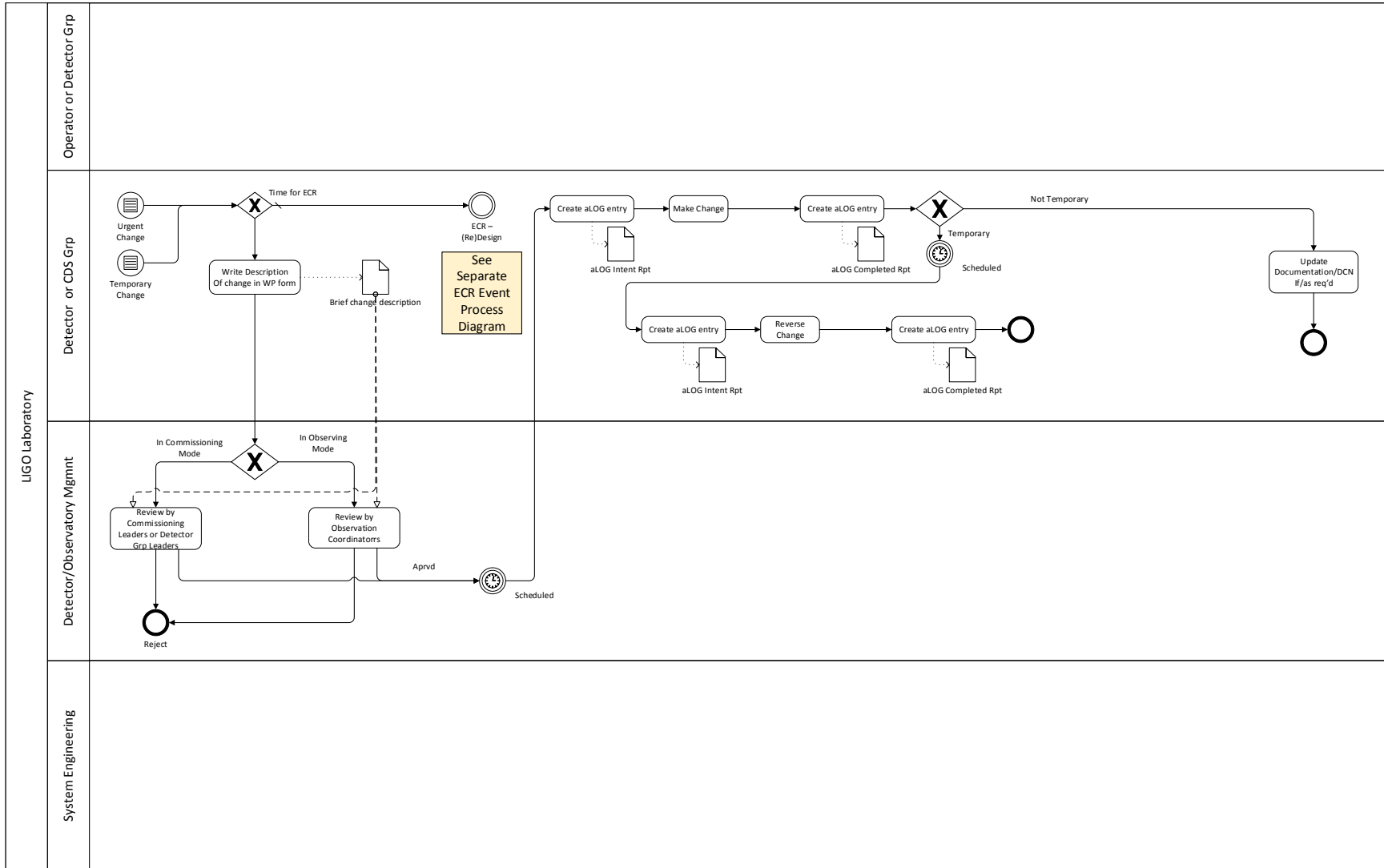

Figure 5 Process Diagram: Temporary or Urgent Changes

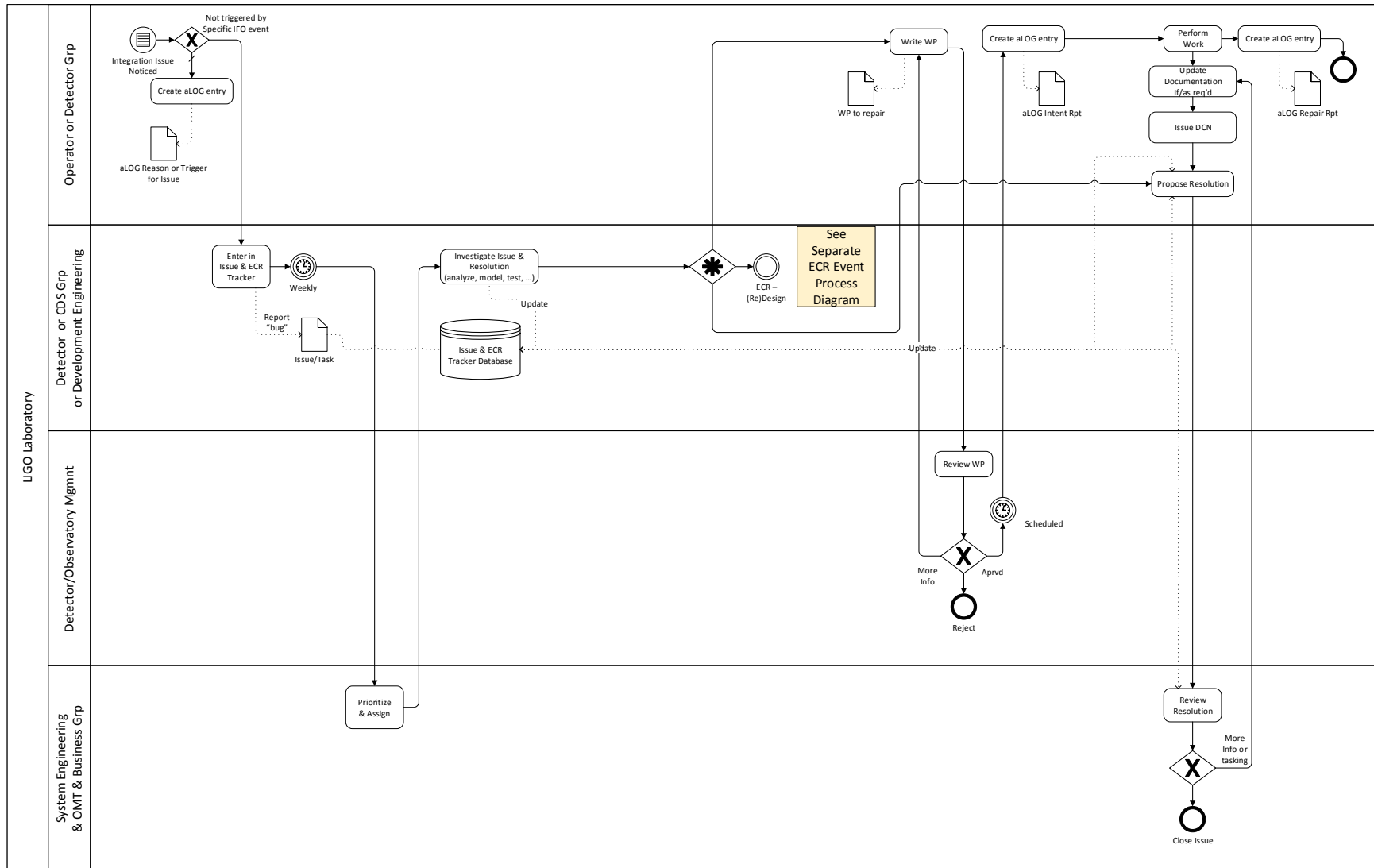

Figure 6 Process Diagram: Integration Issue

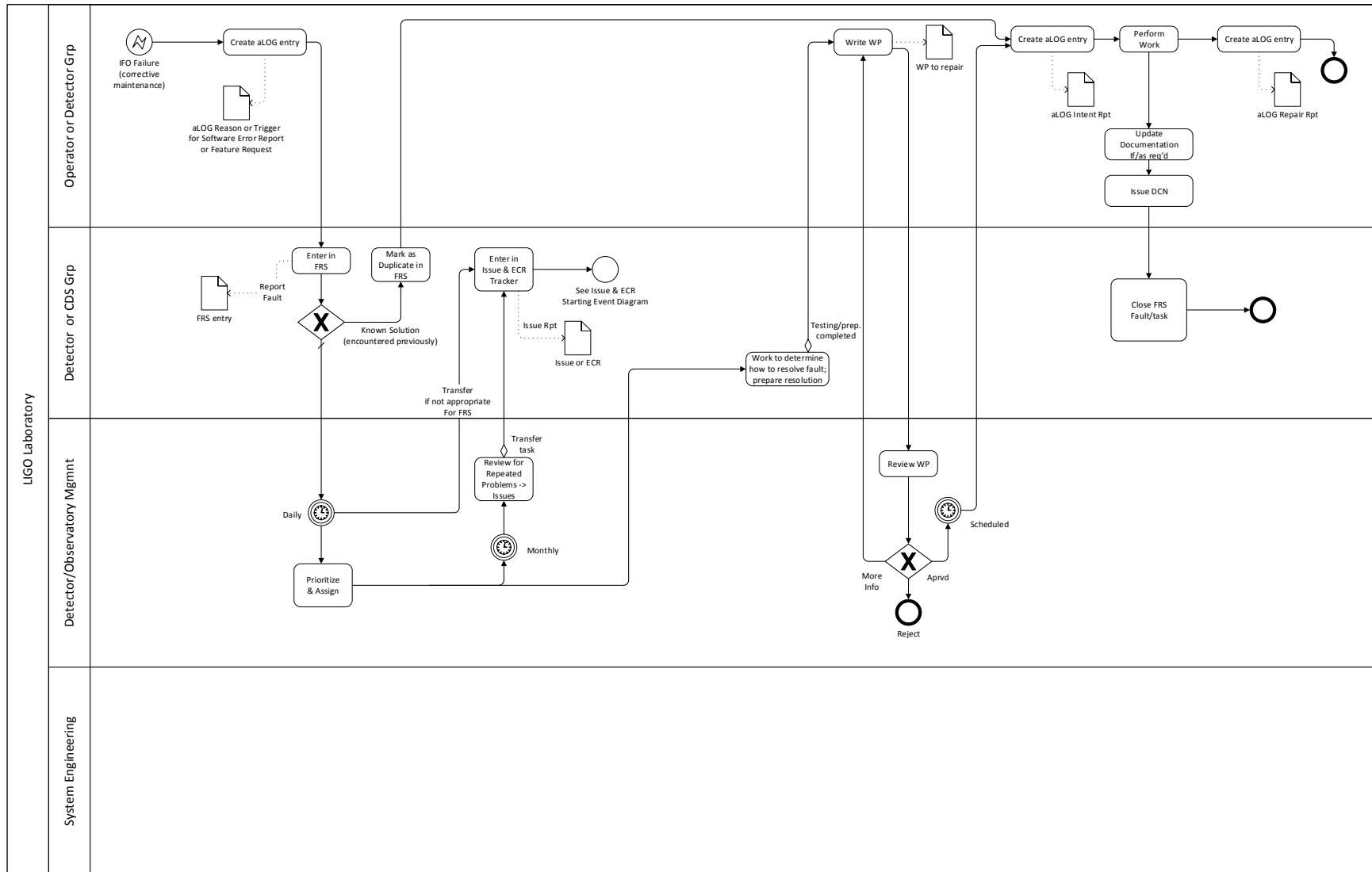

Figure 7 Process Diagram: Detector (IFO) Failure

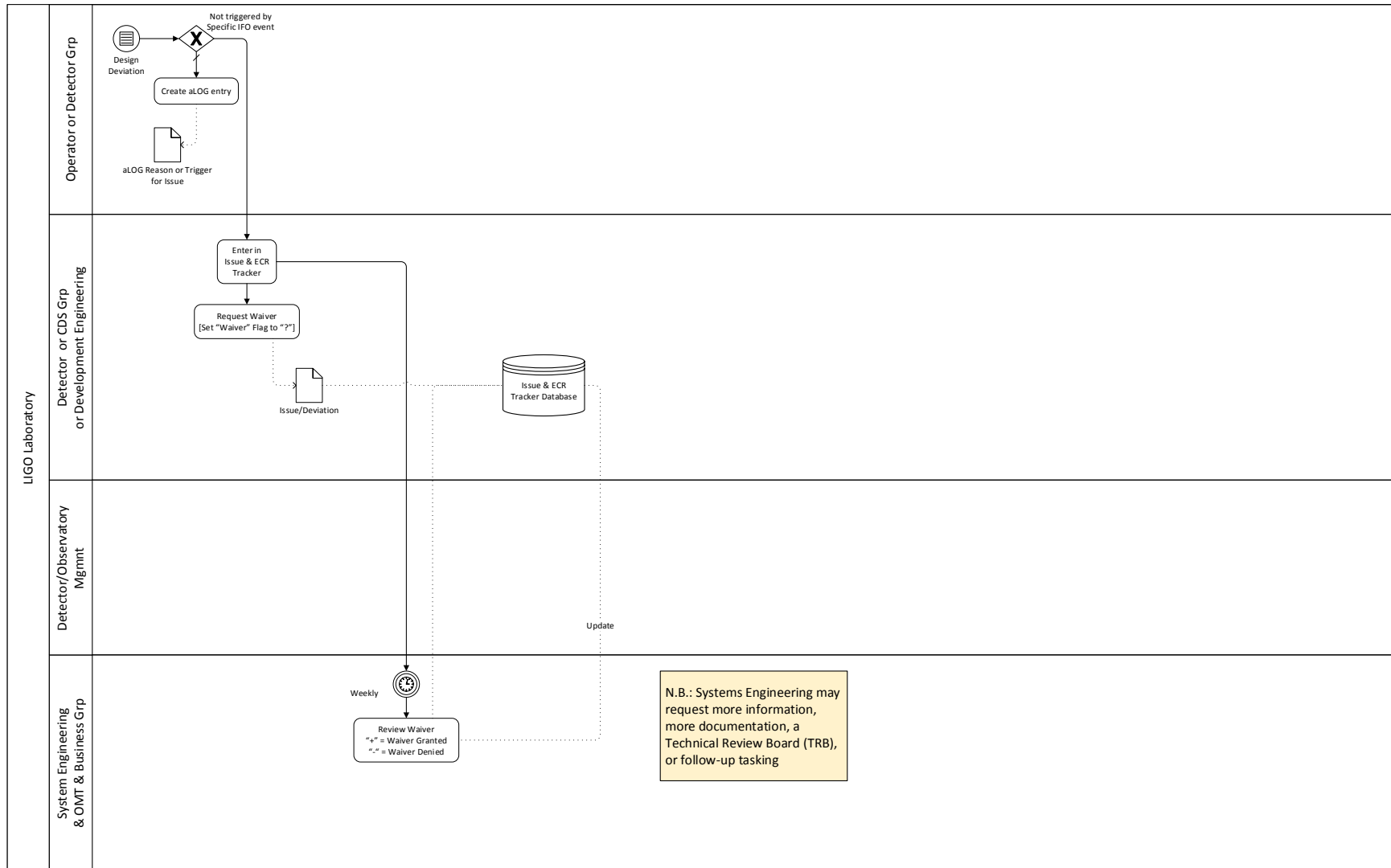

Figure 8 Process Diagram: Design Deviation



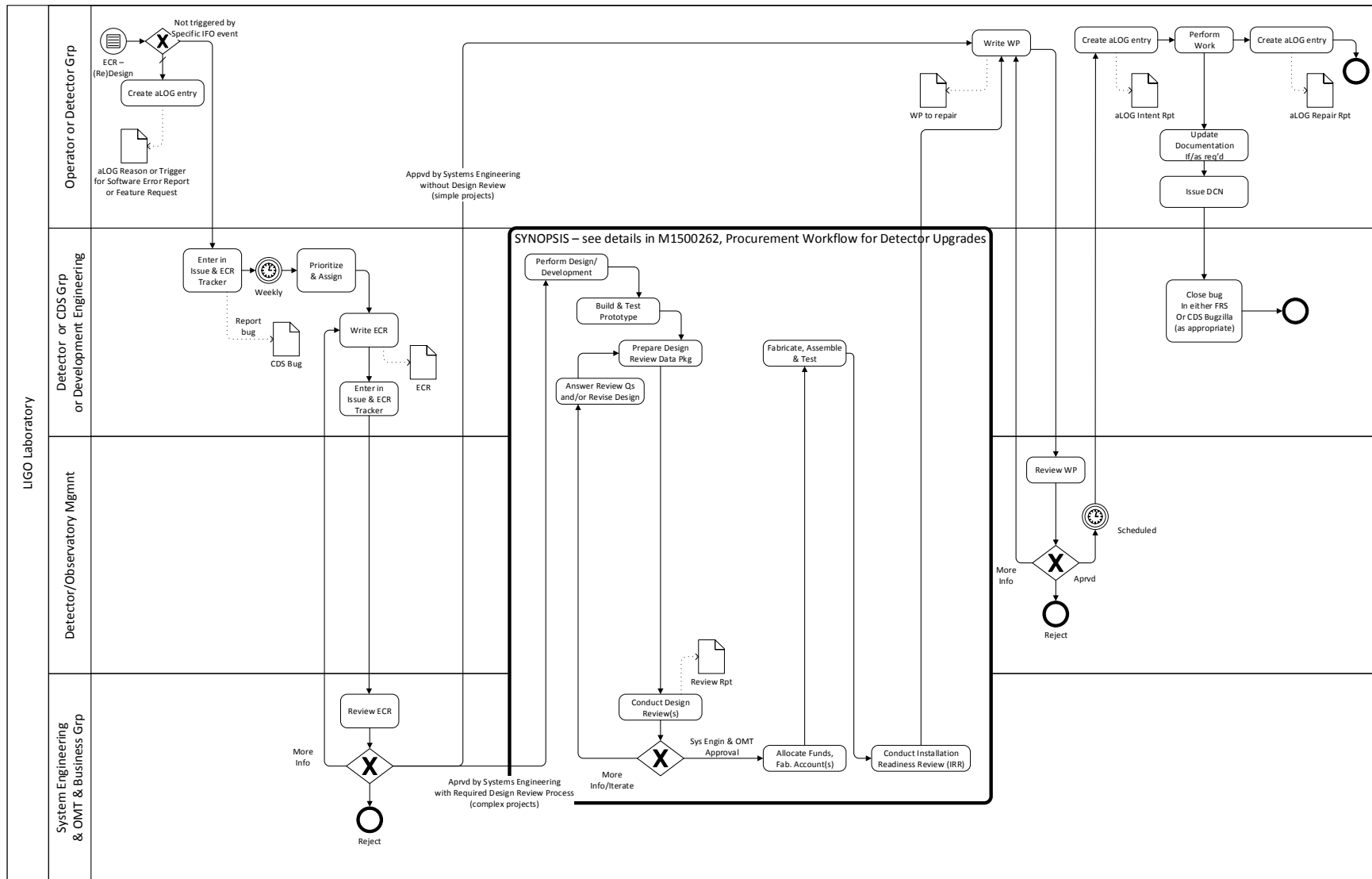

Figure 9 Process Diagram: Engineering Change Request (ECR)

## 7 BPMN Synopsis

Using Business Process Model and Notation (BPMN), created a Business Process Diagram (BPD). The purpose of a BPD is not to diagram a procedure – it is to represent the overall business process.

A short synopsis of BPMN can be found in Wikipedia:

[https://en.wikipedia.org/wiki/Business\\_Process\\_Model\\_and\\_Notation](https://en.wikipedia.org/wiki/Business_Process_Model_and_Notation)

A more complete reference can be found at camunda.org, an open source:

<https://camunda.org/bpmn/reference/>

The LIGO Operations BPD was generated with Microsoft Visio.