

H1 EtherCat Corner 1

H1EcatC1 Target: 10.40.10.1.1.1

Site: H1
 BasePath: C:\SlowControls\TwinCAT3\Source\Interferometer
 Directory: H1EcatC1\Configure
 SaveToProject: True
 Auto Priority: True
 Enable C++ debugger: False
 MaxCPUs: 4
 IsolatedCPUs: 2

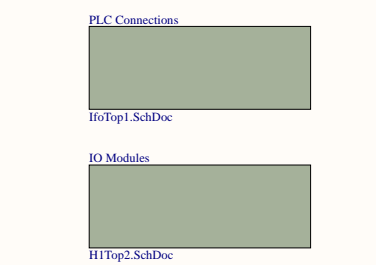
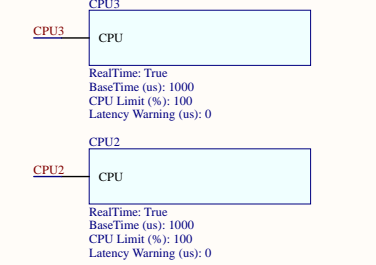
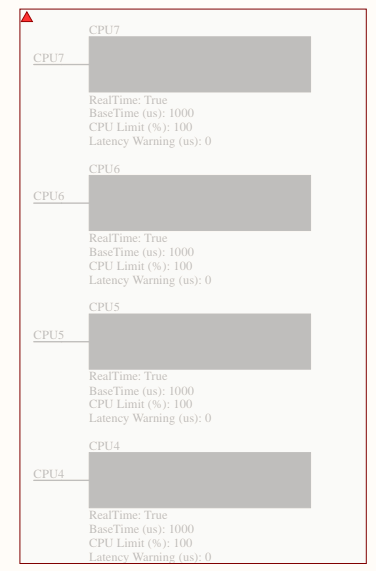
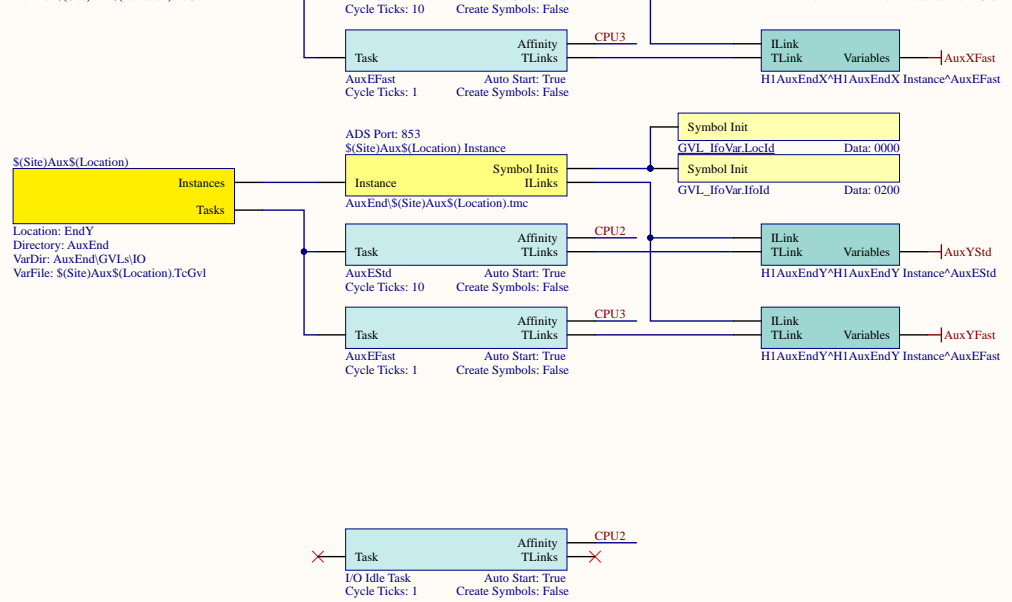
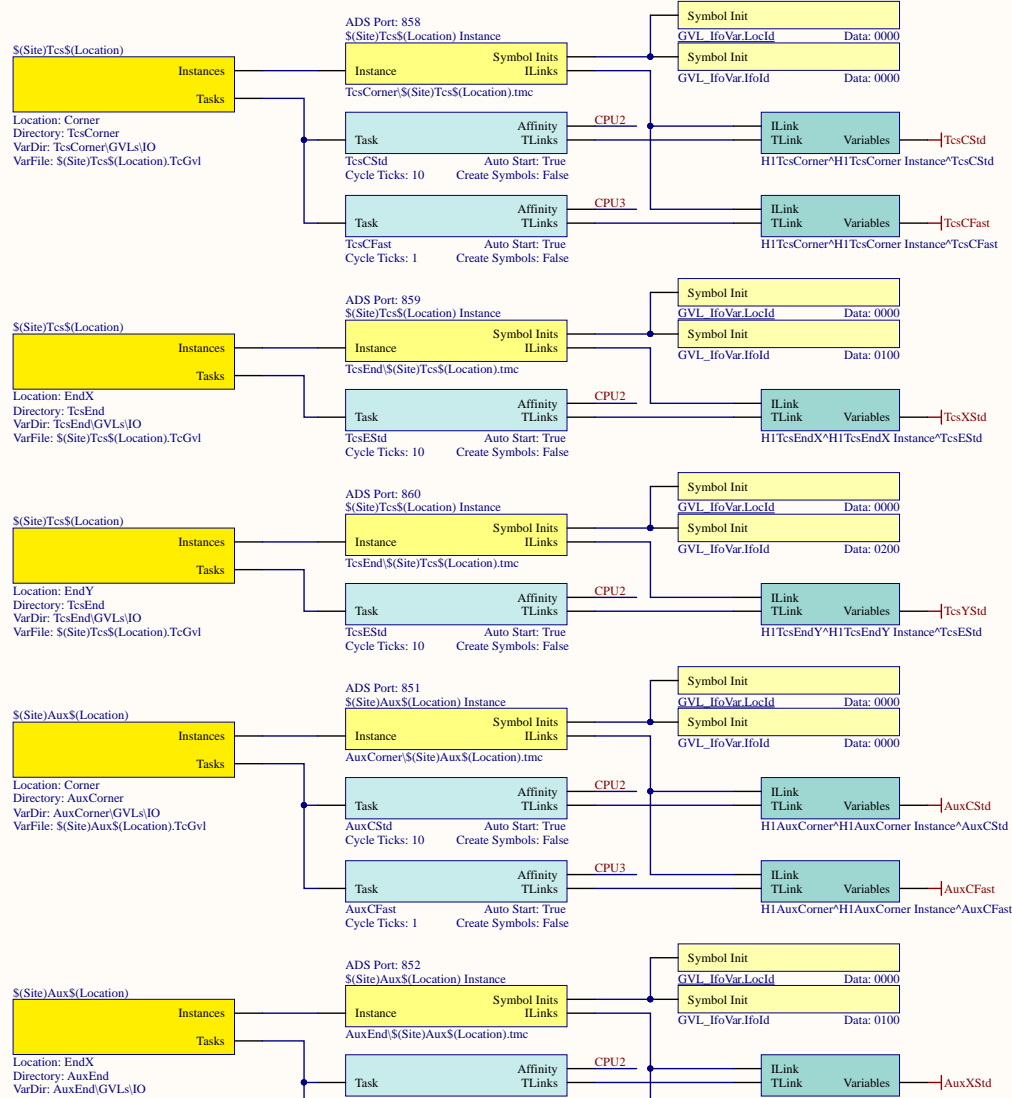
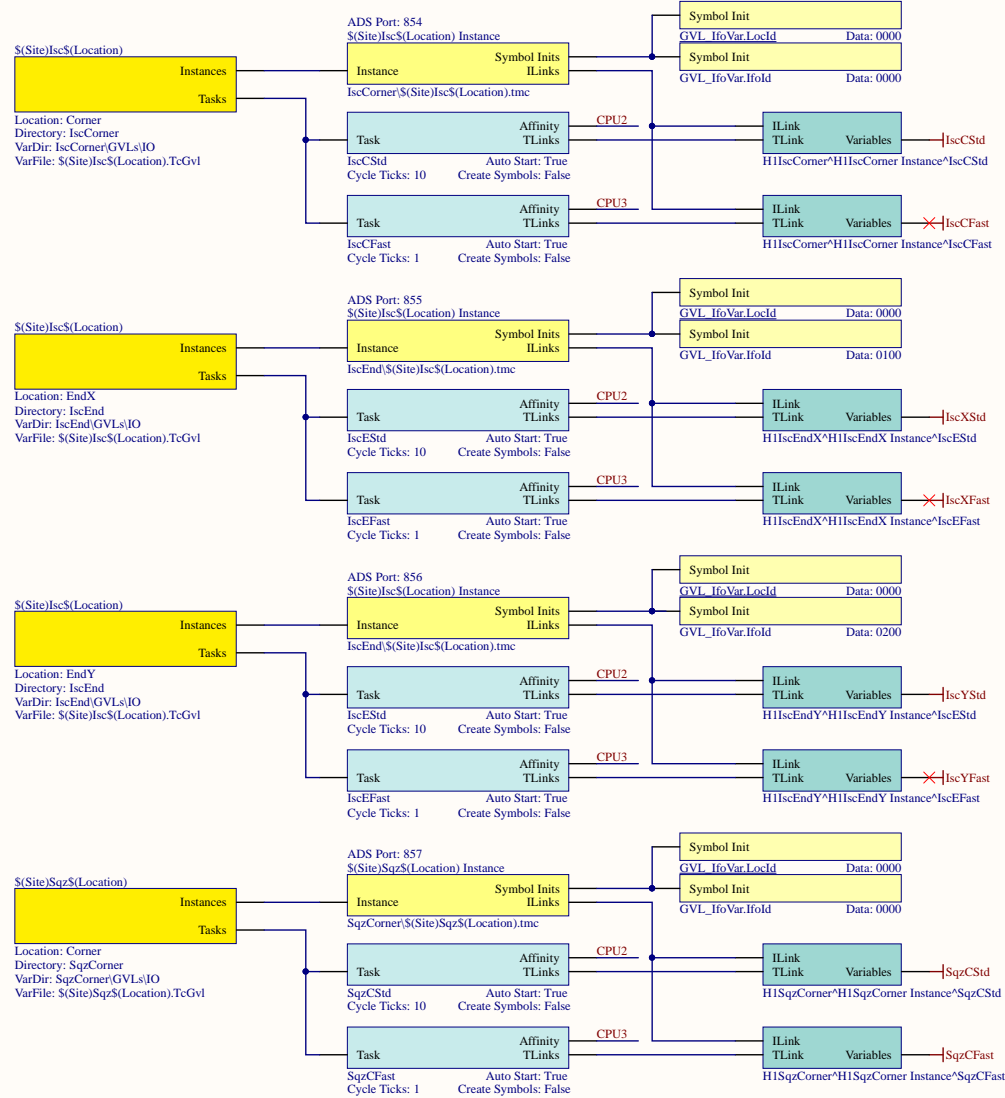

Title: EtherCAT System: H1EcatC1		
Size	Number	Revision
c	D1800185	3
Date:	8/31/2022	Sheet 1 of 31
File:	C:\SlowControls\H1IfoSystem.SchDoc Drawn By: Daniel Sig	

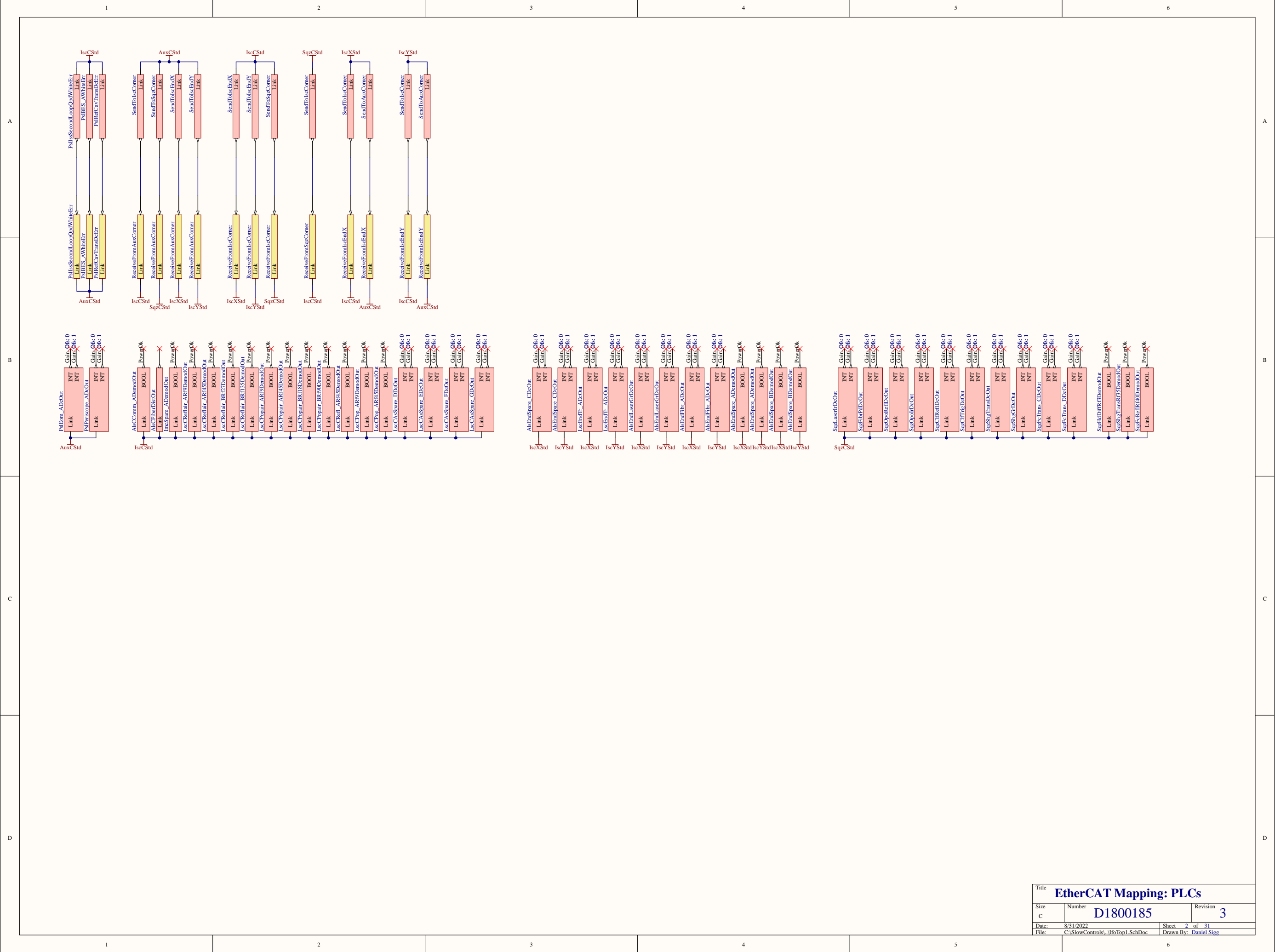

Title EtherCAT Mapping: PLCs		
Size c	Number D1800185	Revision 3
Date:	8/31/2022	Sheet 2 of 31
File:	C:\SlowControls\...lfoTop1.SchDoc	Drawn By: Daniel Sig

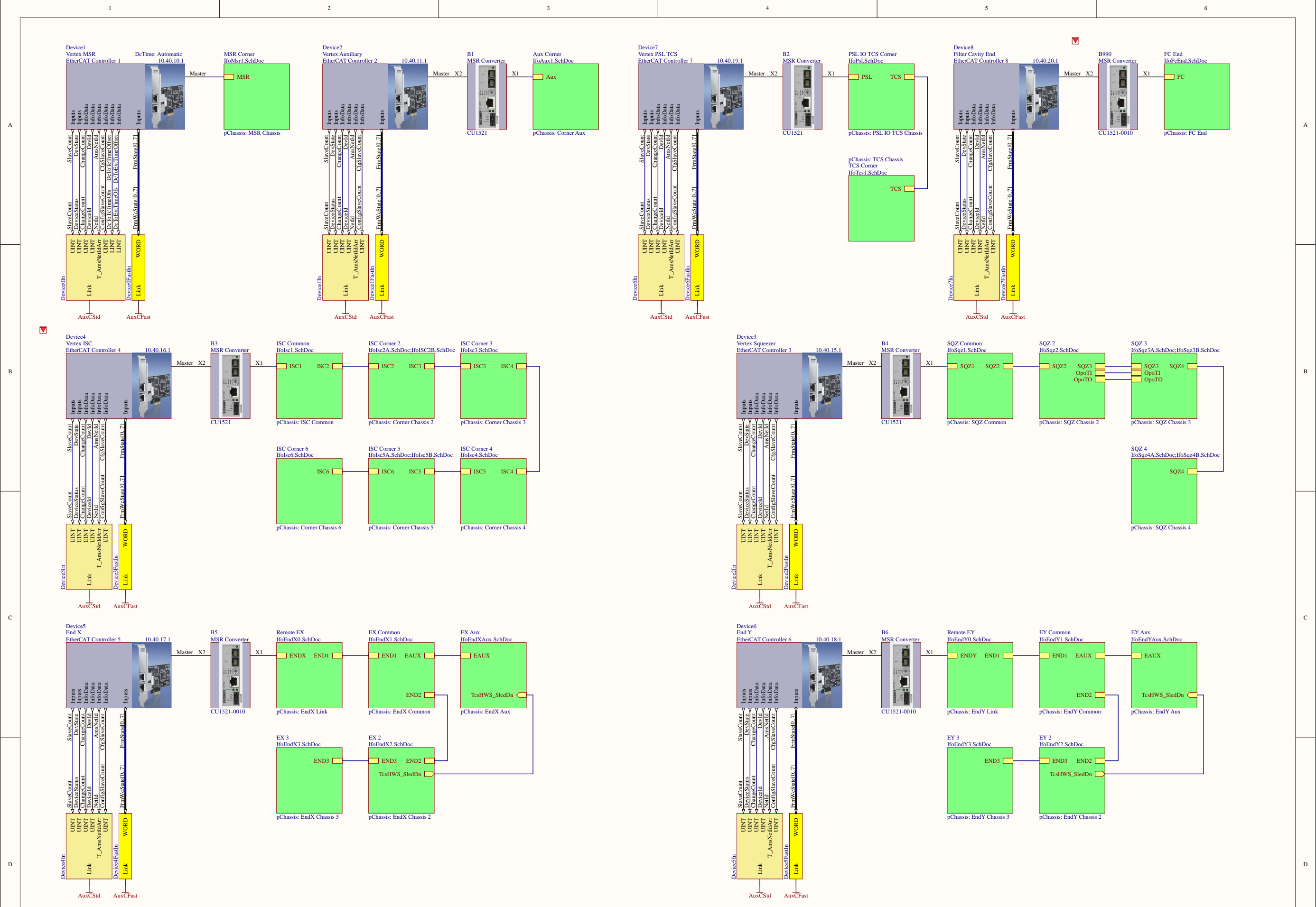

Title EtherCAT Mapping: Devices		
Size c	Number D1800185	Revision 3
Date: 8/31/2022	Sheet 3 of 31	
File: C:\SlowControls\...JH1Top2.SchDoc	Drawn By: Daniel Sig	

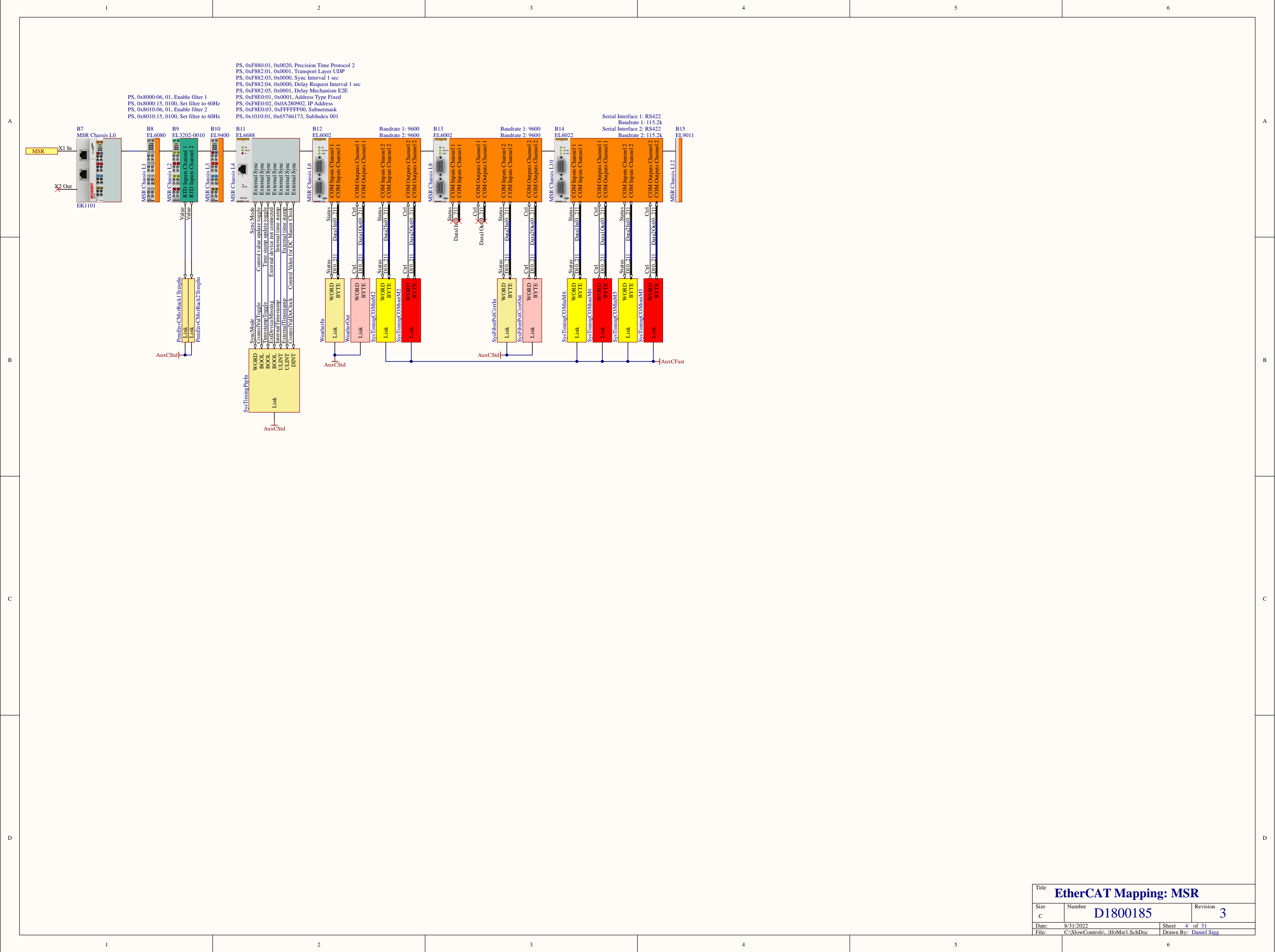

Title EtherCAT Mapping: MSR		
Size c	Number D1800185	Revision 3
Date:	8/31/2022	Sheet 4 of 31
File:	C:\SlowControls\...lfoMsr1.SchDoc	Drawn By: Daniel Sig

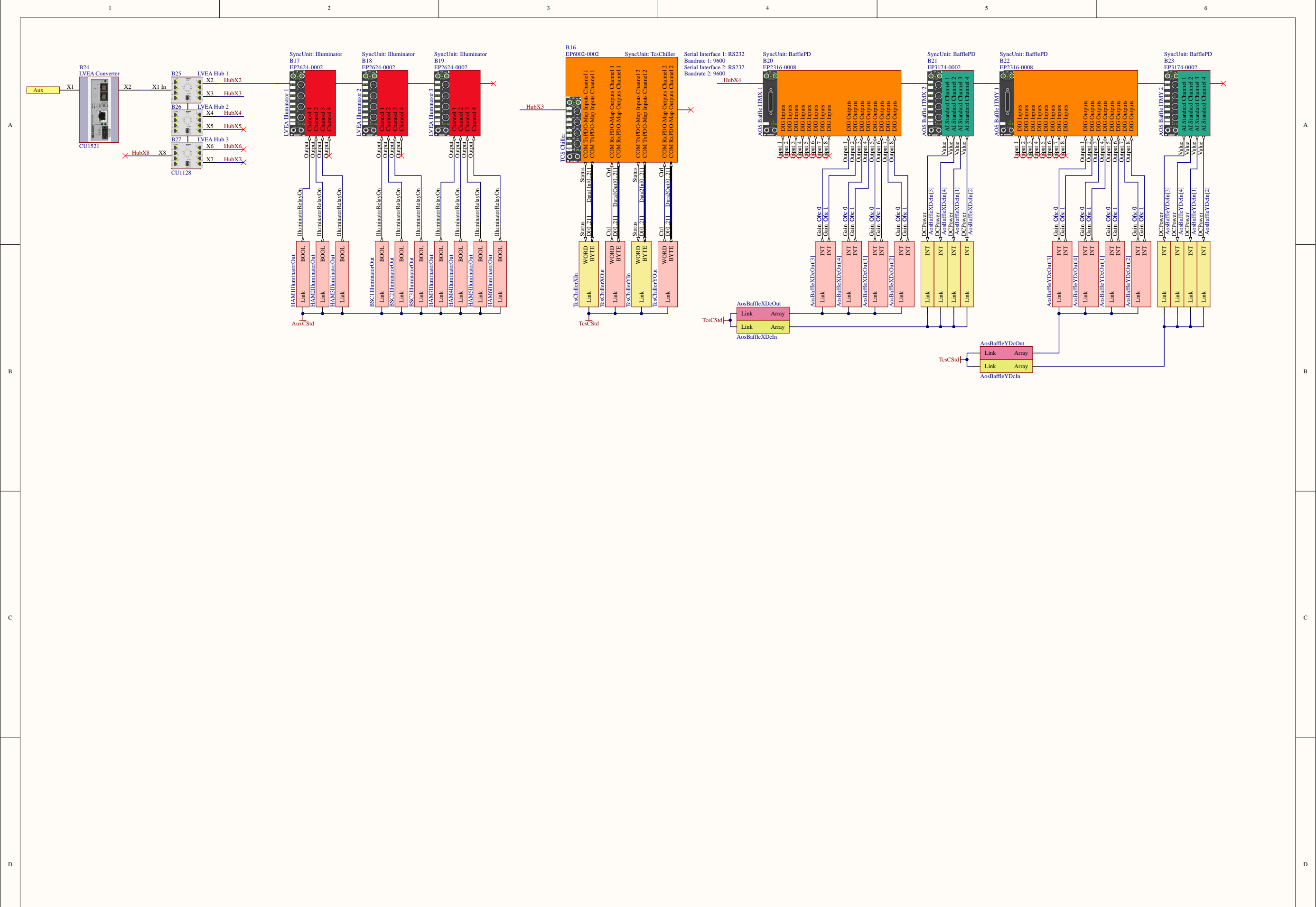

Title			EtherCAT Mapping: LVEA		
Size	Number	Revision		3	
c	D1800185				
Date:	8/31/2022	Sheet	5 of 31		
File:	C:\SlowControls\...lfoAux1.SchDoc	Drawn By:	Daniel Sigga		

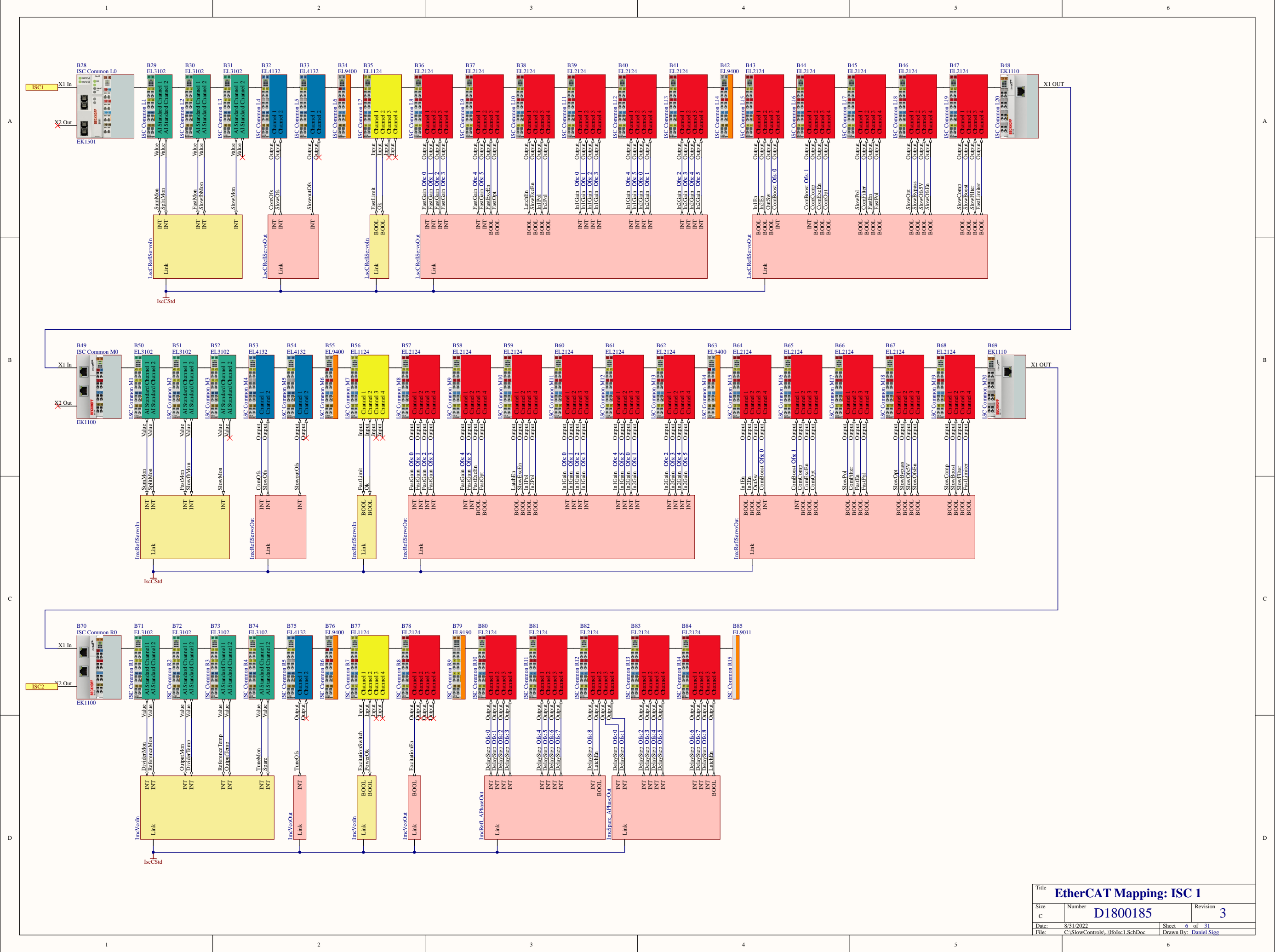

Title EtherCAT Mapping: ISC 1		
Size	Number	Revision
c	D1800185	3
Date:	8/31/2022	Sheet 6 of 31
File:	C:\SlowControls\...lfoIsc1.SchDoc	Drawn By: Daniel Sig

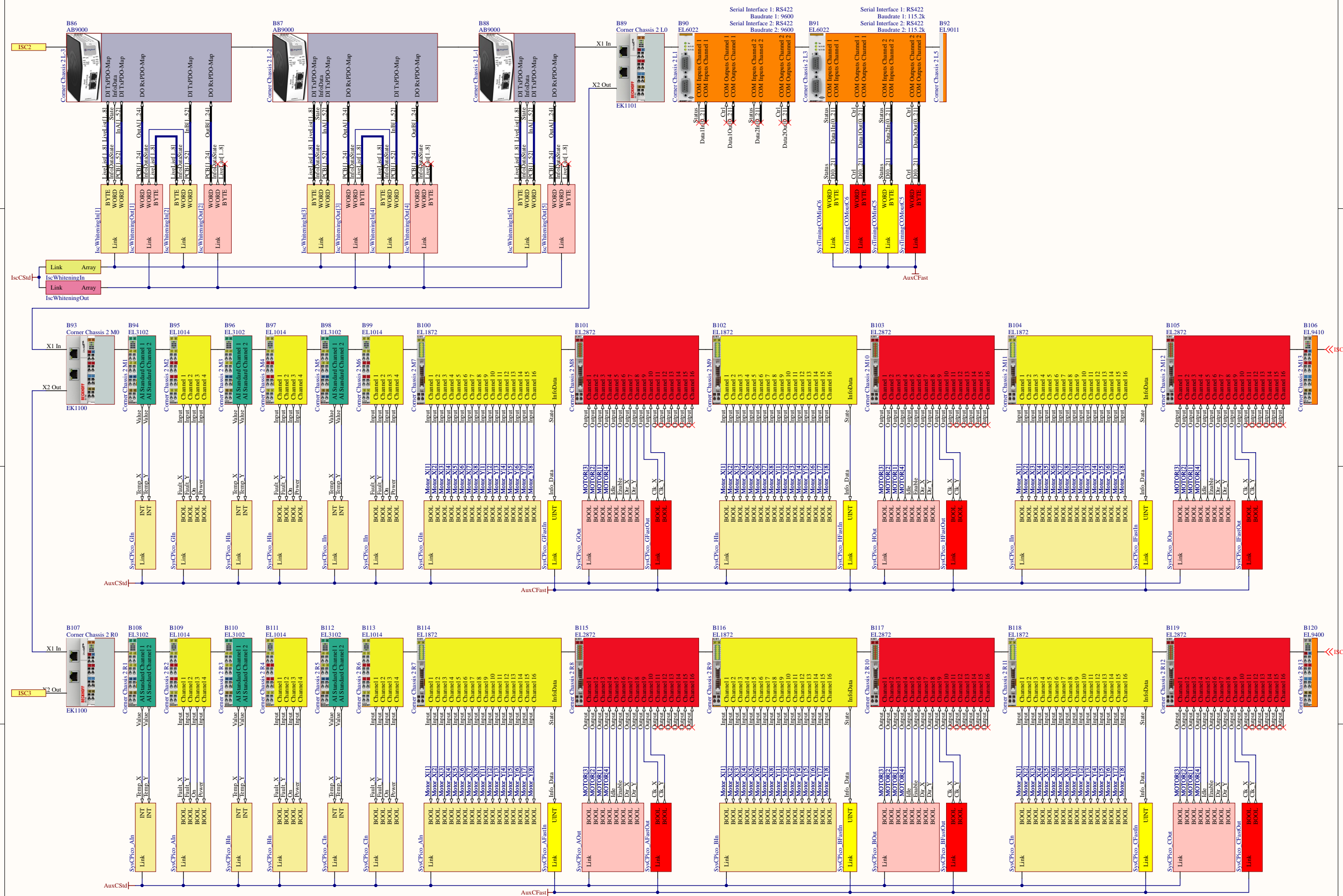

Title EtherCAT Mapping: ISC 2A		
Size c	Number D1800185	Revision 3
Date: 8/31/2022	Sheet 7 of 31	Drawn By: Daniel Sig
File: C:\SlowControls\...ifolsc2A.SchDoc	Drawn By: Daniel Sig	

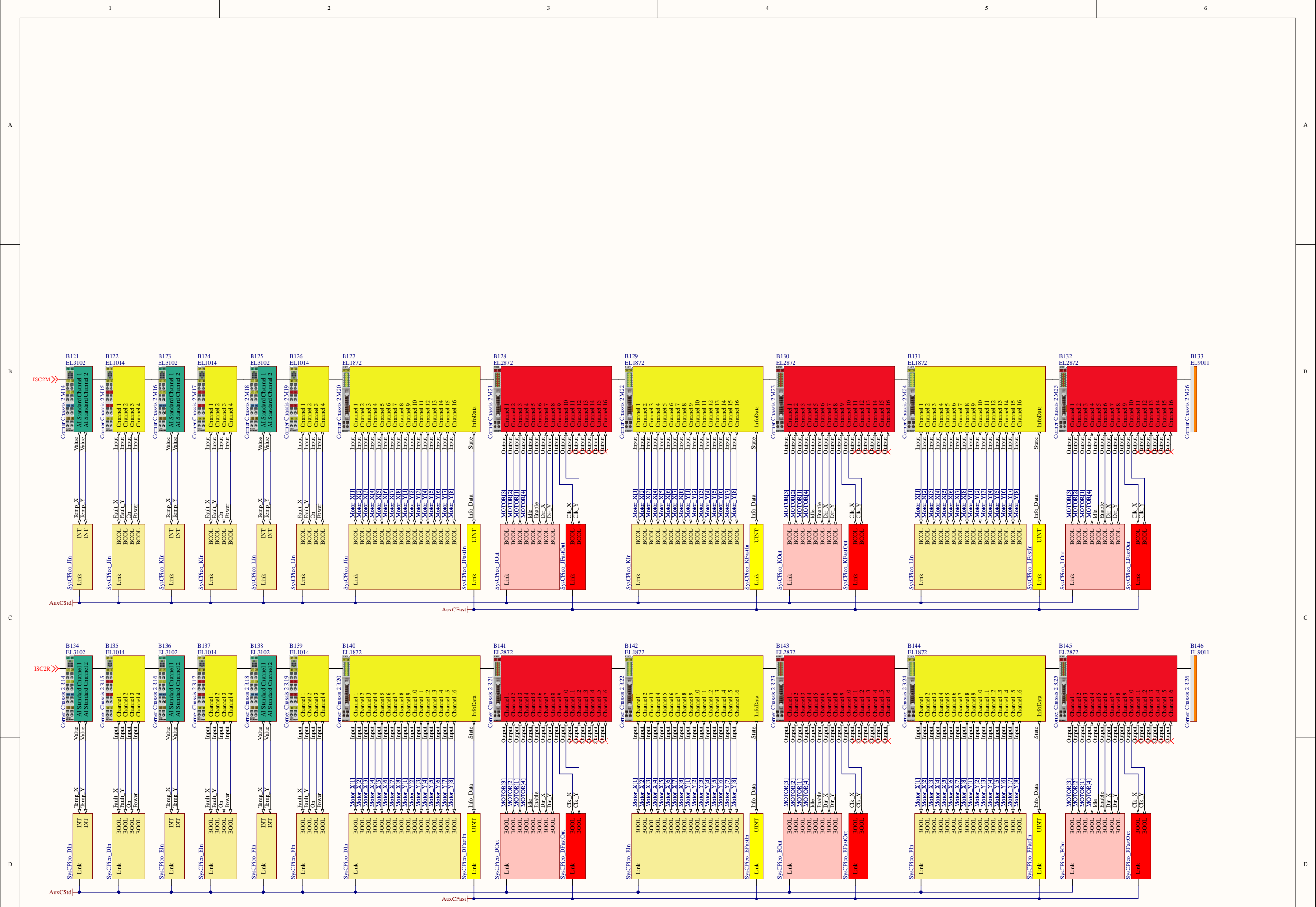

Title EtherCAT Mapping: ISC 2B		
Size c	Number D1800185	Revision 3
Date: 8/31/2022	Sheet 8 of 31	Drawn By: Daniel Sig
File: C:\SlowControls\...lfisc2B.SchDoc		

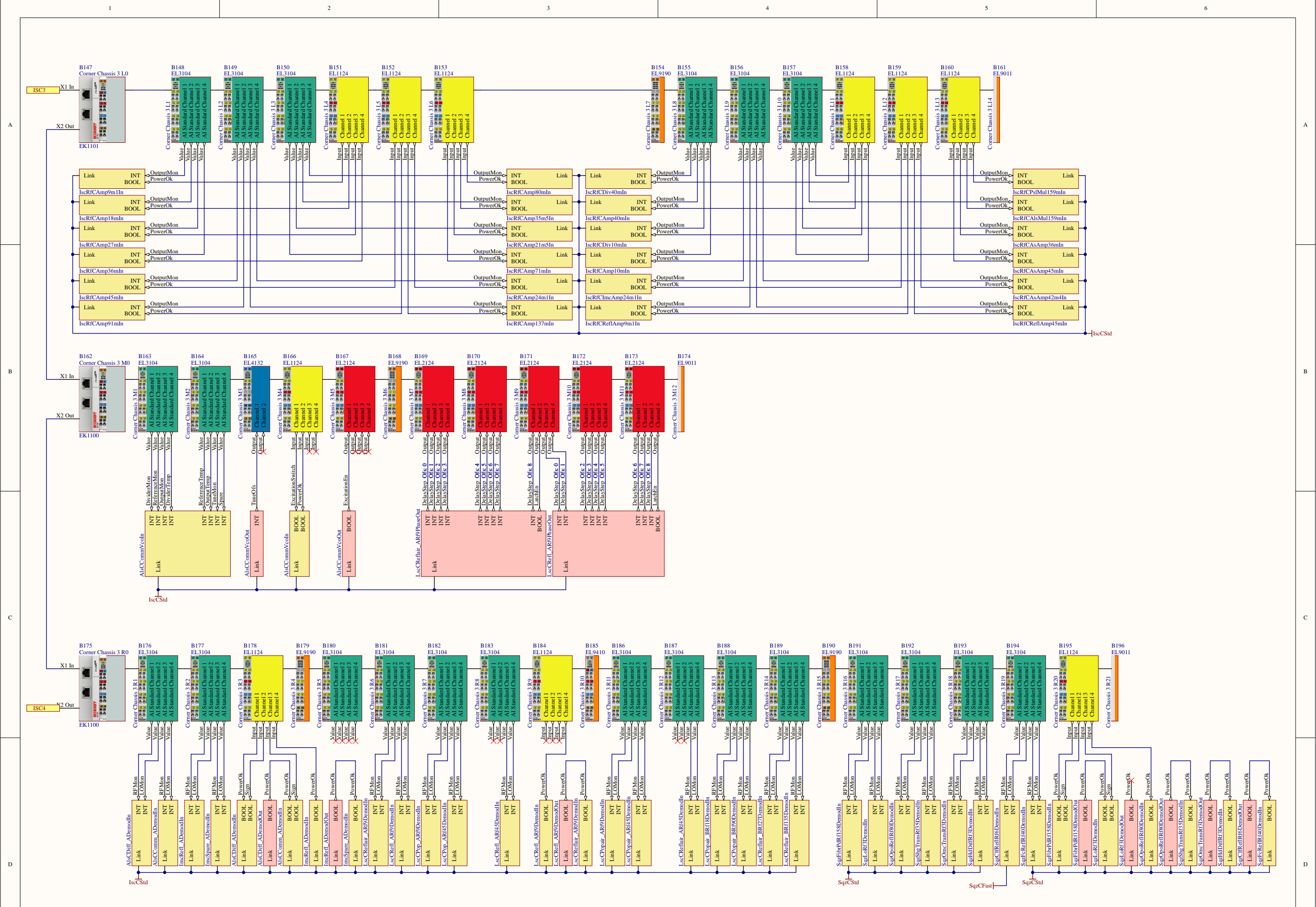

Title EtherCAT Mapping: ISC 3		
Size	Number	Revision
c	D1800185	3
Date:	8/31/2022	Sheet 9 of 31
File:	C:\SlowControls\...ifolisc3.SchDoc	Drawn By: Daniel Sig



Title EtherCAT Mapping: ISC 4		
Size	Number	Revision
c	D1800185	3
Date:	8/31/2022	Sheet 10 of 31
File:	C:\SlowControls\...lfolsc4.SchDoc	Drawn By: Daniel Sig

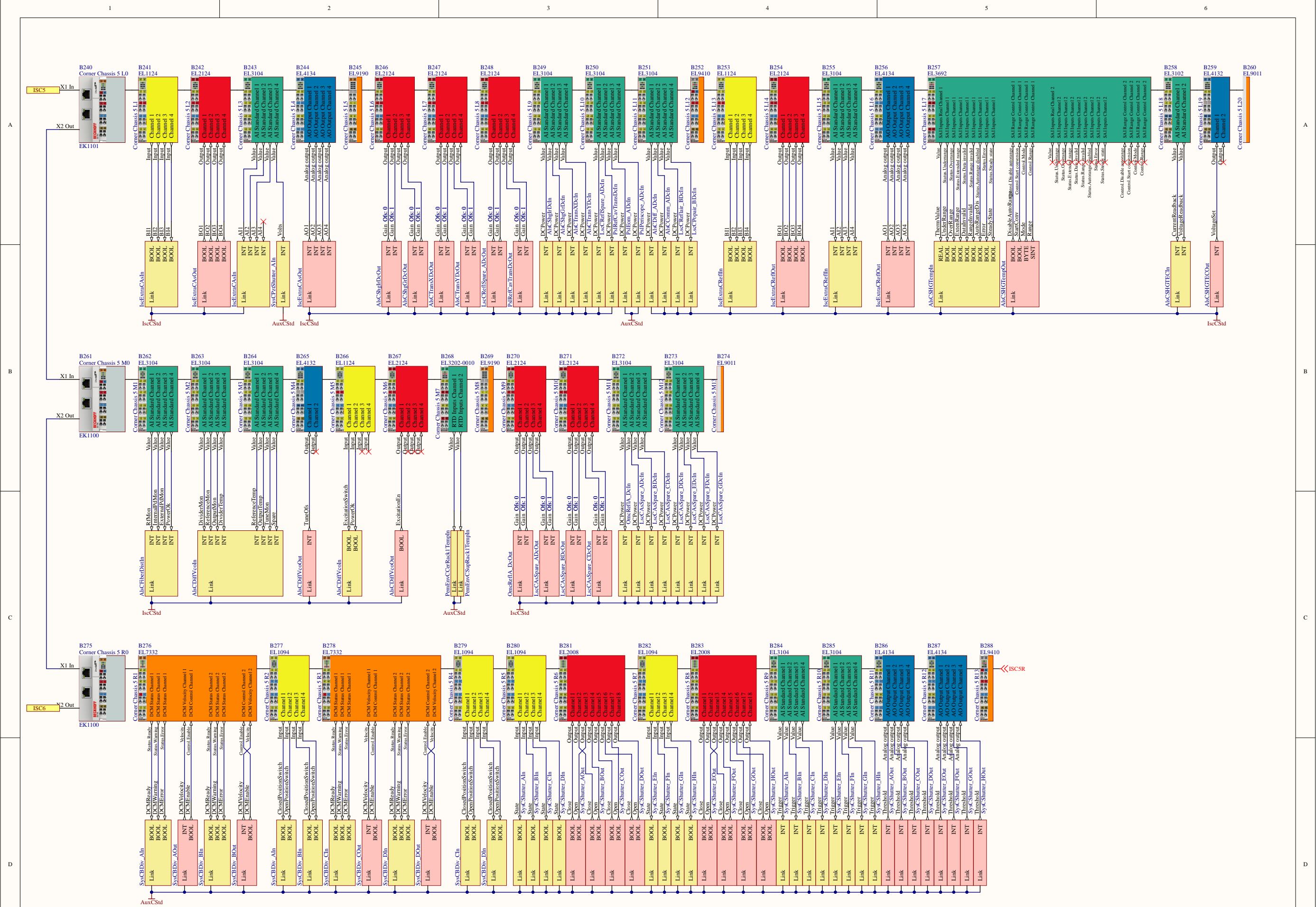

Title EtherCAT Mapping: ISC 5A		
Size c	Number D1800185	Revision 3
Date: 8/31/2022	Sheet 11 of 31	
File: C:\SlowControls\...lfolisc5A.SchDoc	Drawn By: Daniel Sig	

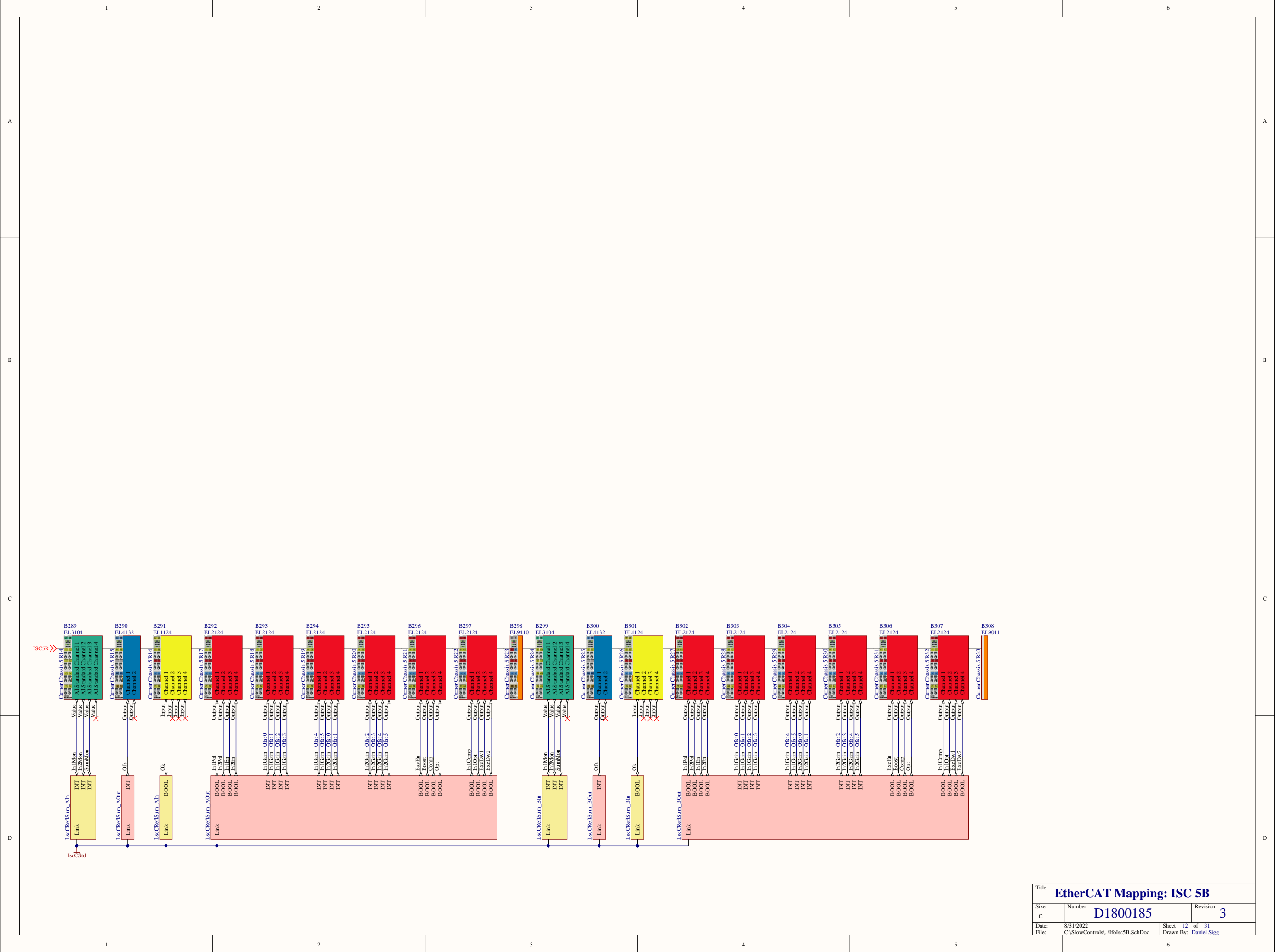

Title EtherCAT Mapping: ISC 5B		
Size	Number	Revision
c	D1800185	3
Date:	8/31/2022	Sheet 12 of 31
File:	C:\SlowControls\...lfolsc5B.SchDoc	Drawn By: Daniel Sig

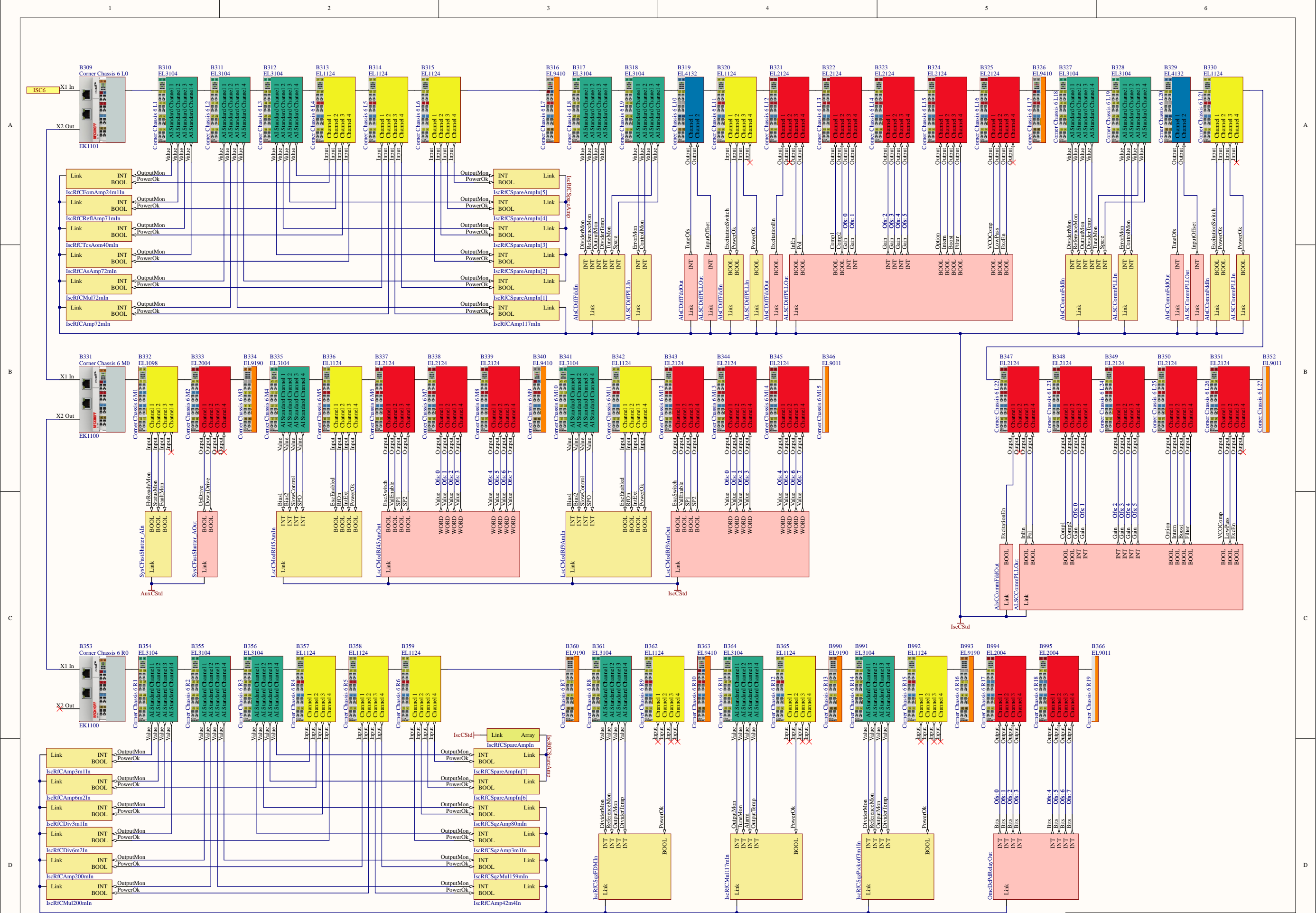

Title EtherCAT Mapping: ISC 6		
Size c	Number D1800185	Revision 3
Date: 8/31/2022	Sheet 13 of 31	Drawn By: Daniel Sig
File: C:\SlowControls\...lfolIsC6.SchDoc		

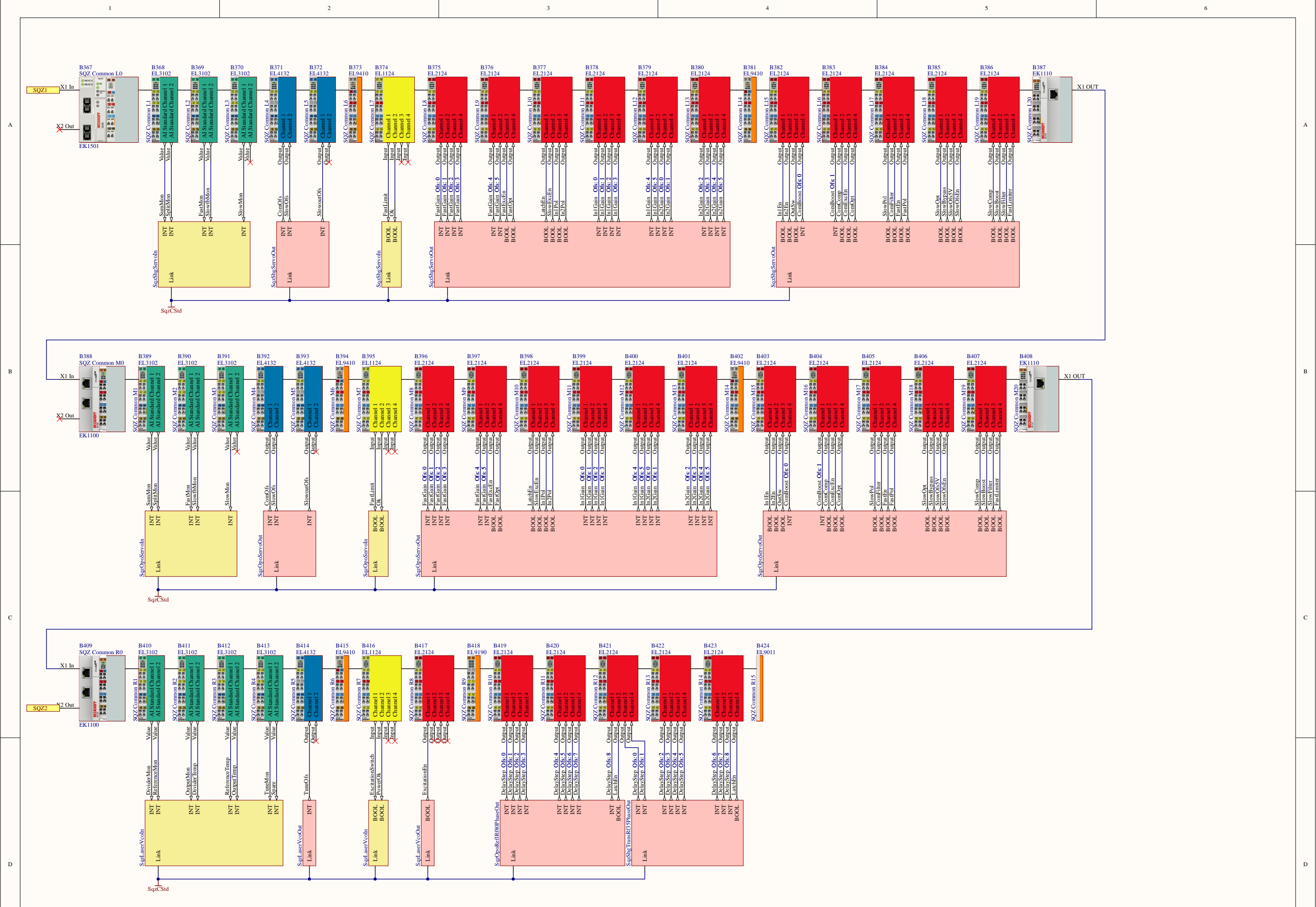

Title EtherCAT Mapping: SQZ 1		
Size	Number	Revision
c	D1800185	3
Date:	8/31/2022	Sheet 14 of 31
File:	C:\SlowControls\...lfoSqz1.SchDoc	Drawn By: Daniel Sig

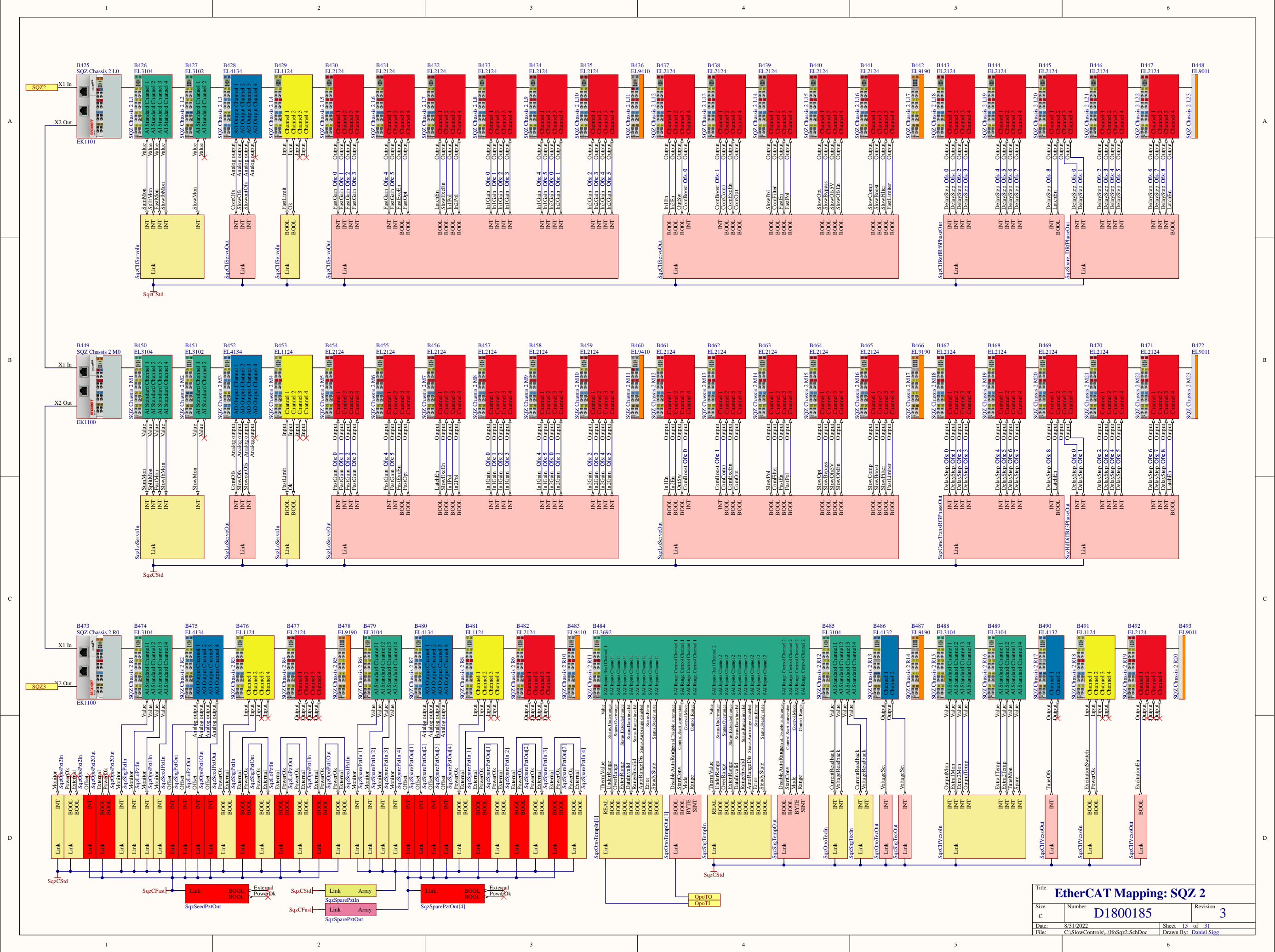

Title		
EtherCAT Mapping: SQZ 2		
Size	Number	Revision
c	D1800185	3
Date:	8/31/2022	Sheet 15 of 31
File:	C:\SlowControls\...lfsoqz2.SchDoc	Drawn By: Daniel Sig

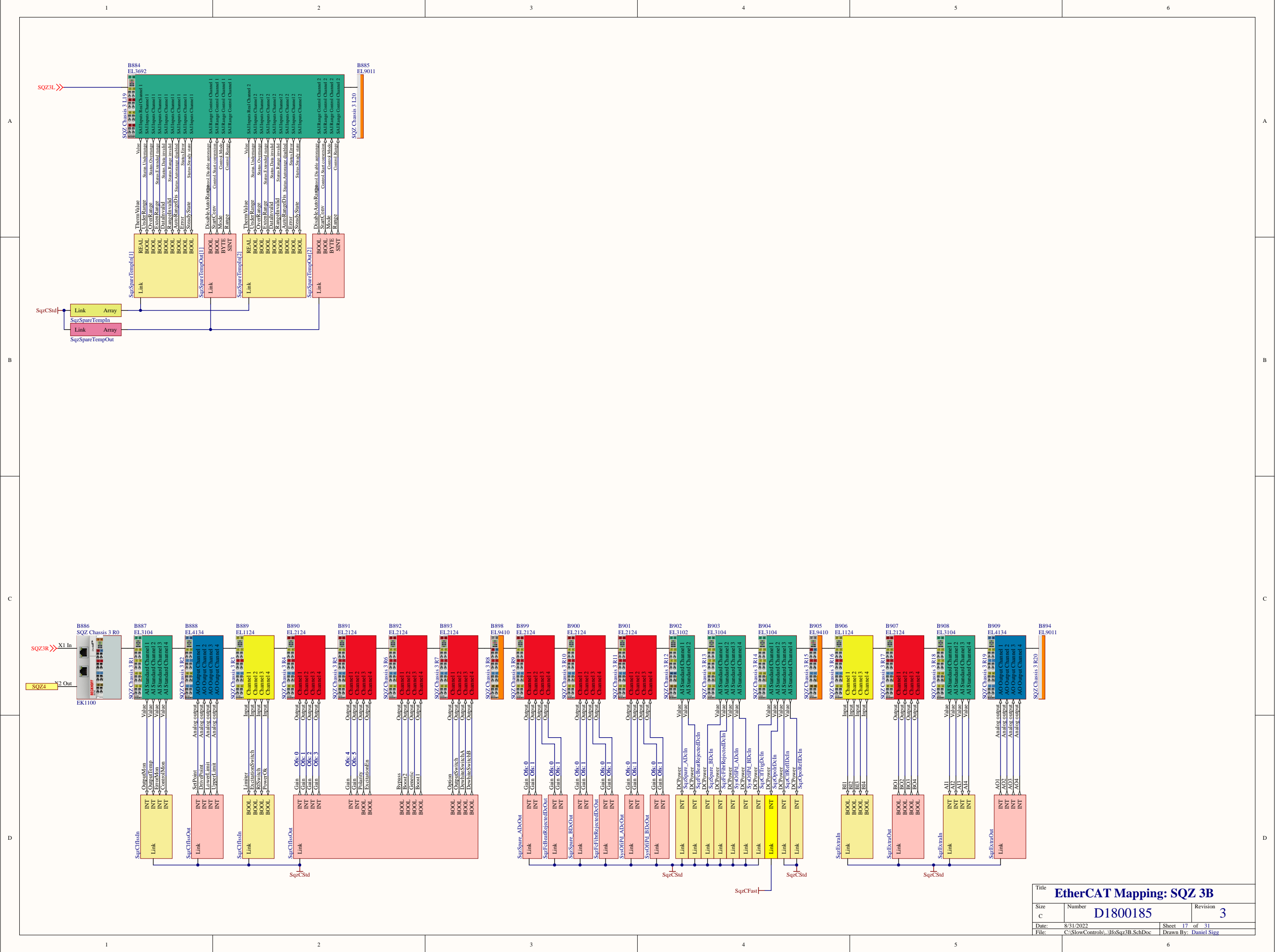

Title EtherCAT Mapping: SQZ 3B		
Size c	Number D1800185	Revision 3
Date: 8/31/2022	Sheet 17 of 31	
File: C:\SlowControls\...lfoSQz3B.SchDoc	Drawn By: Daniel Sig	

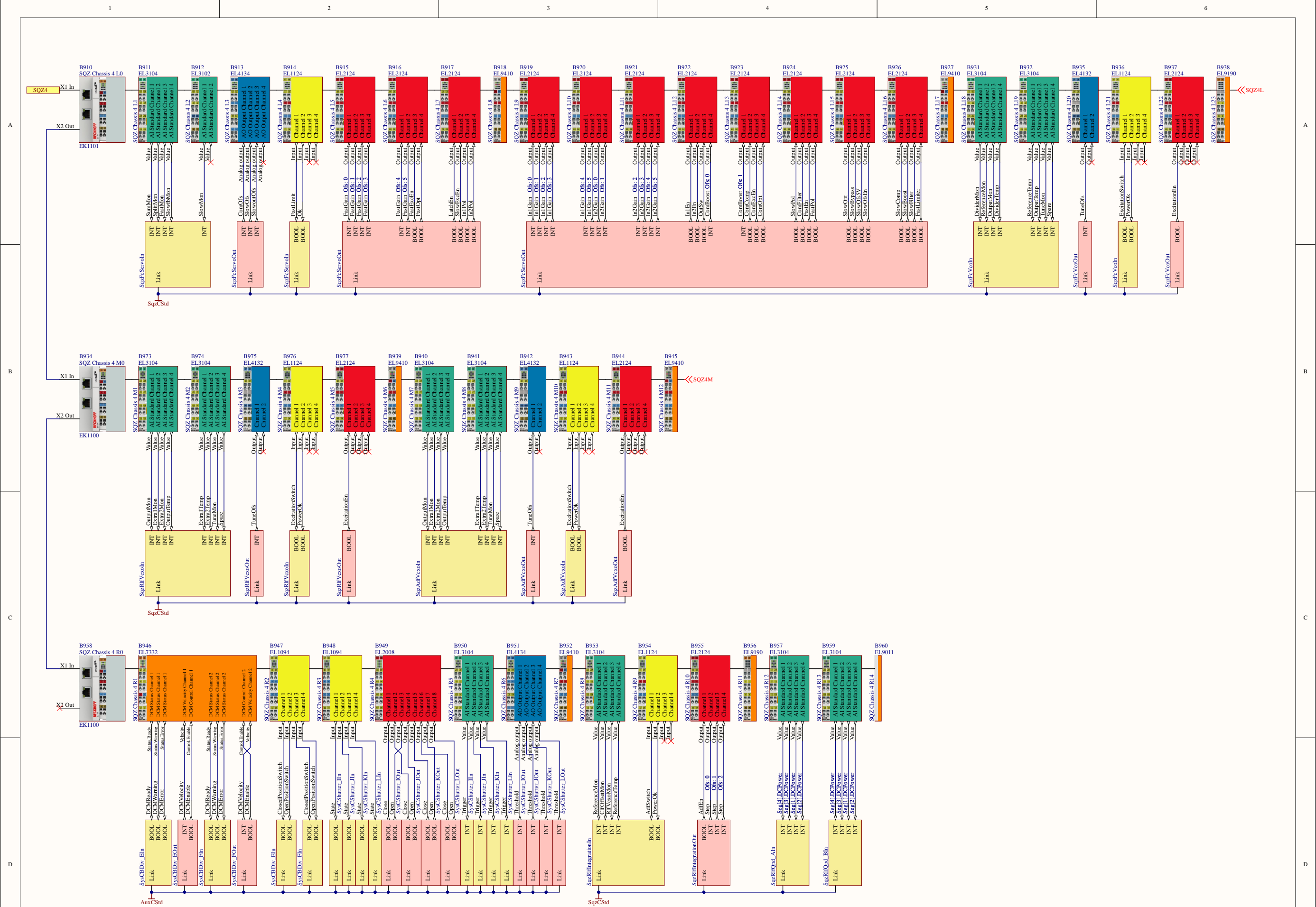

Title EtherCAT Mapping: SQZ 4A		
Size	Number	Revision
c	D1800185	3
Date:	8/31/2022	Sheet 18 of 31
File:	C:\SlowControls\...lfoSqz4A.SchDoc	Drawn By: Daniel Sig

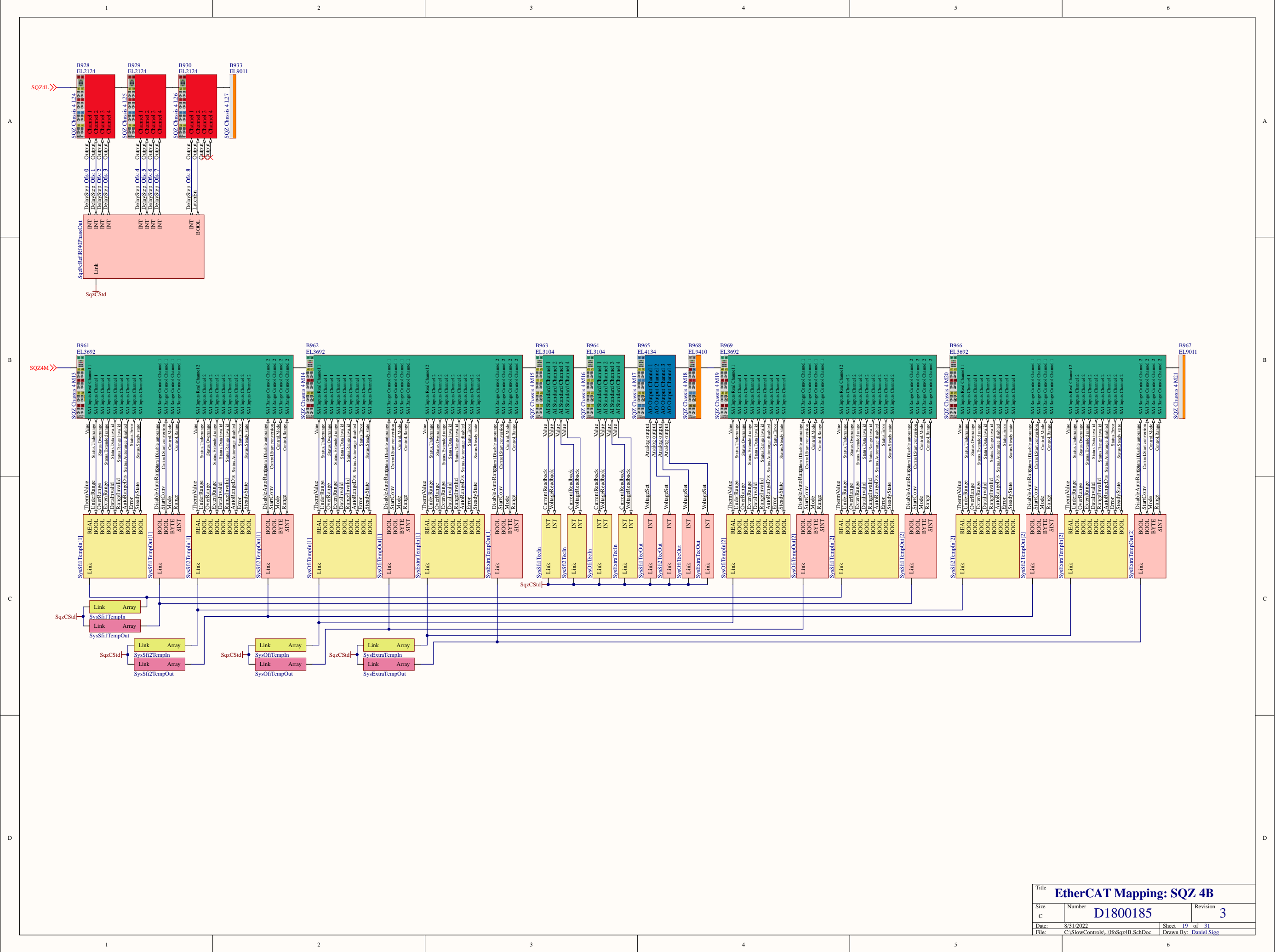

Title EtherCAT Mapping: SQZ 4B		
Size c	Number D1800185	Revision 3
Date: 8/31/2022	Sheet 19 of 31	Drawn By: Daniel Sig
File: C:\SlowControls\lifoSqz4B.SchDoc		

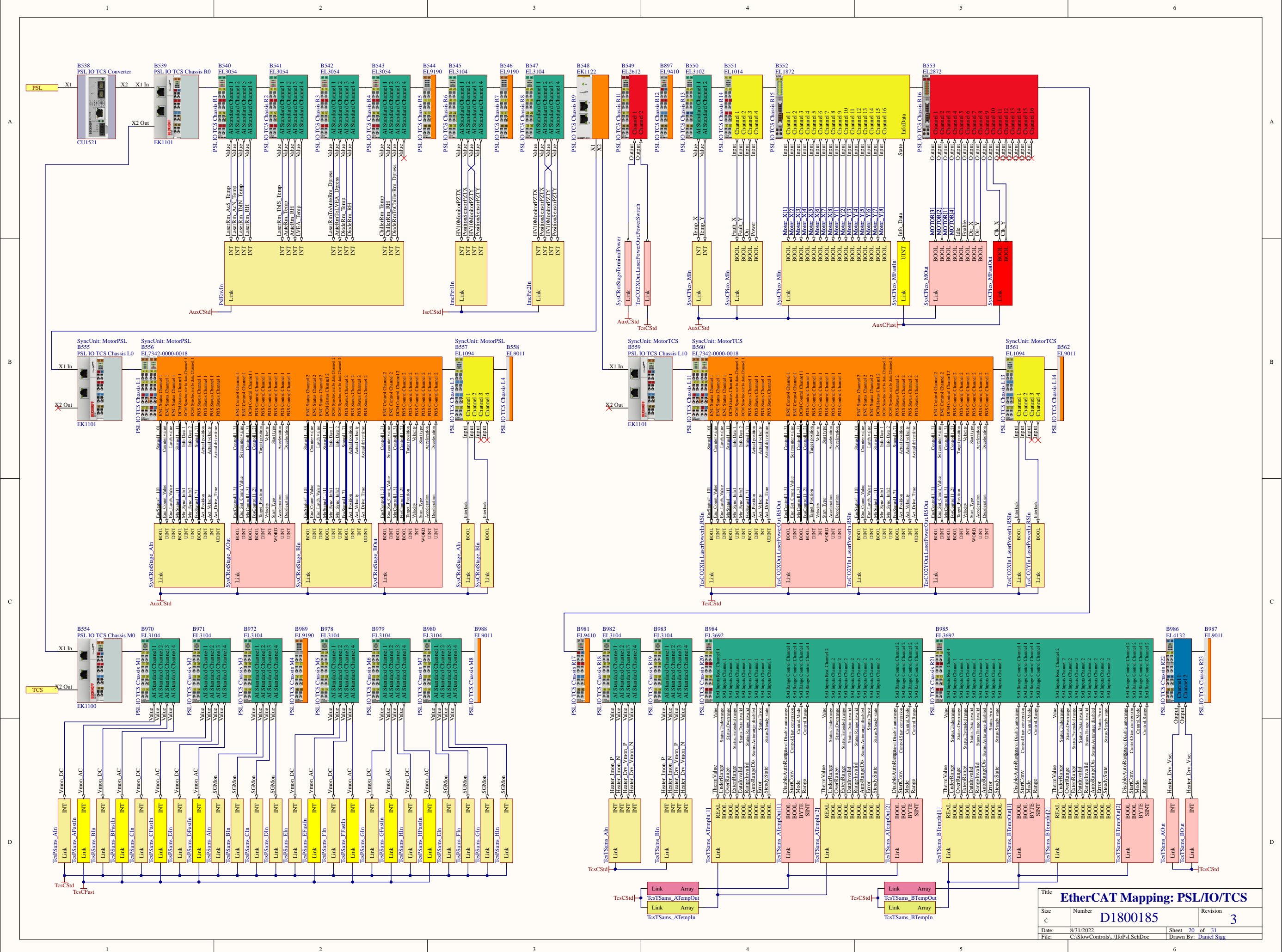

Title		
EtherCAT Mapping: PSL/IO/TCS		
Size	Number	Revision
c	D1800185	3
Date:	8/31/2022	Sheet 20 of 31
File:	C:\SlowControls\...lfoPsl.SchDoc	Drawn By: Daniel Sig

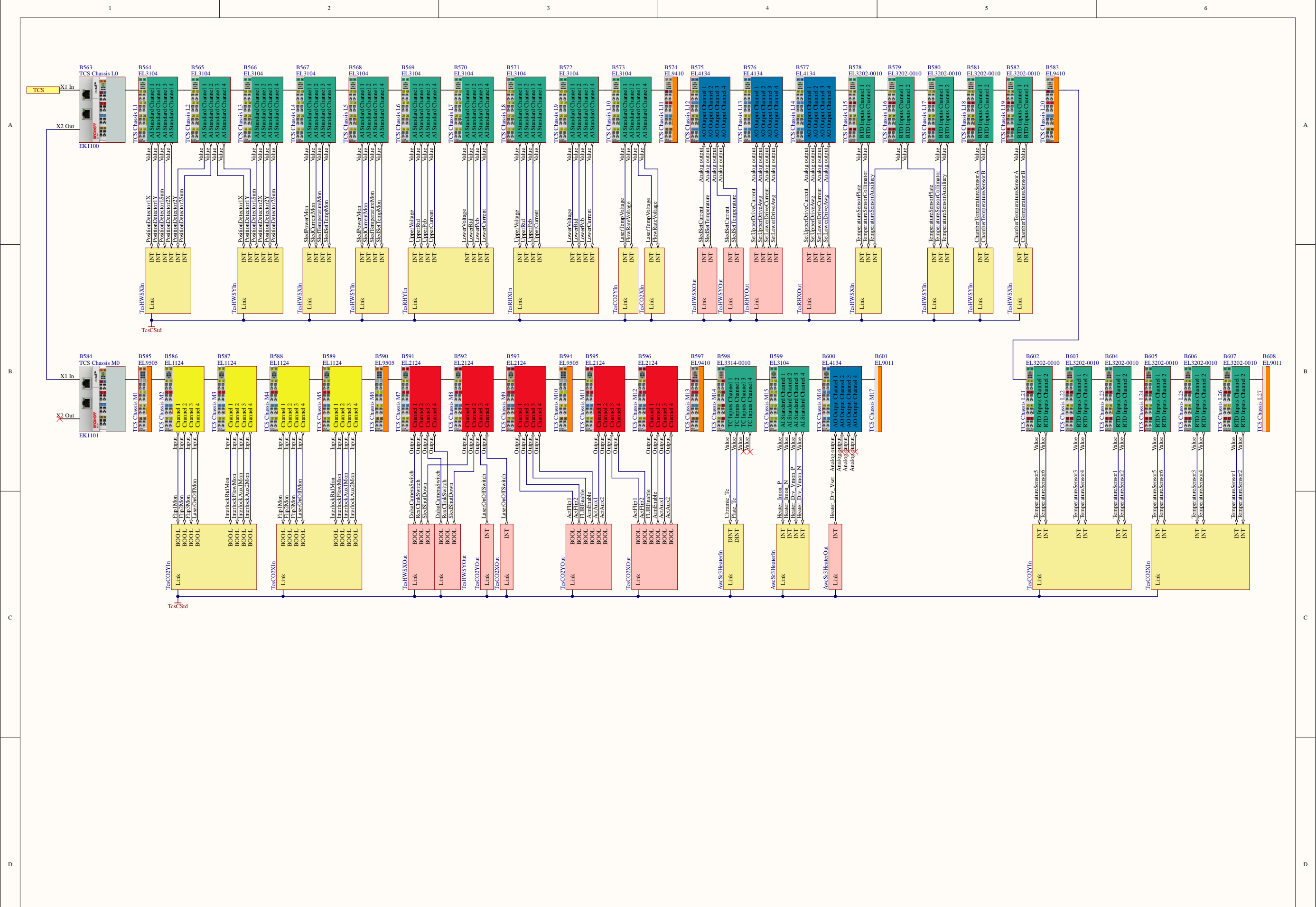

Title EtherCAT Mapping: TCS		
Size c	Number D1800185	Revision 3
Date: 8/31/2022	Sheet 21 of 31	
File: C:\SlowControls\...lfoTcs1.SchDoc	Drawn By: Daniel Sig	

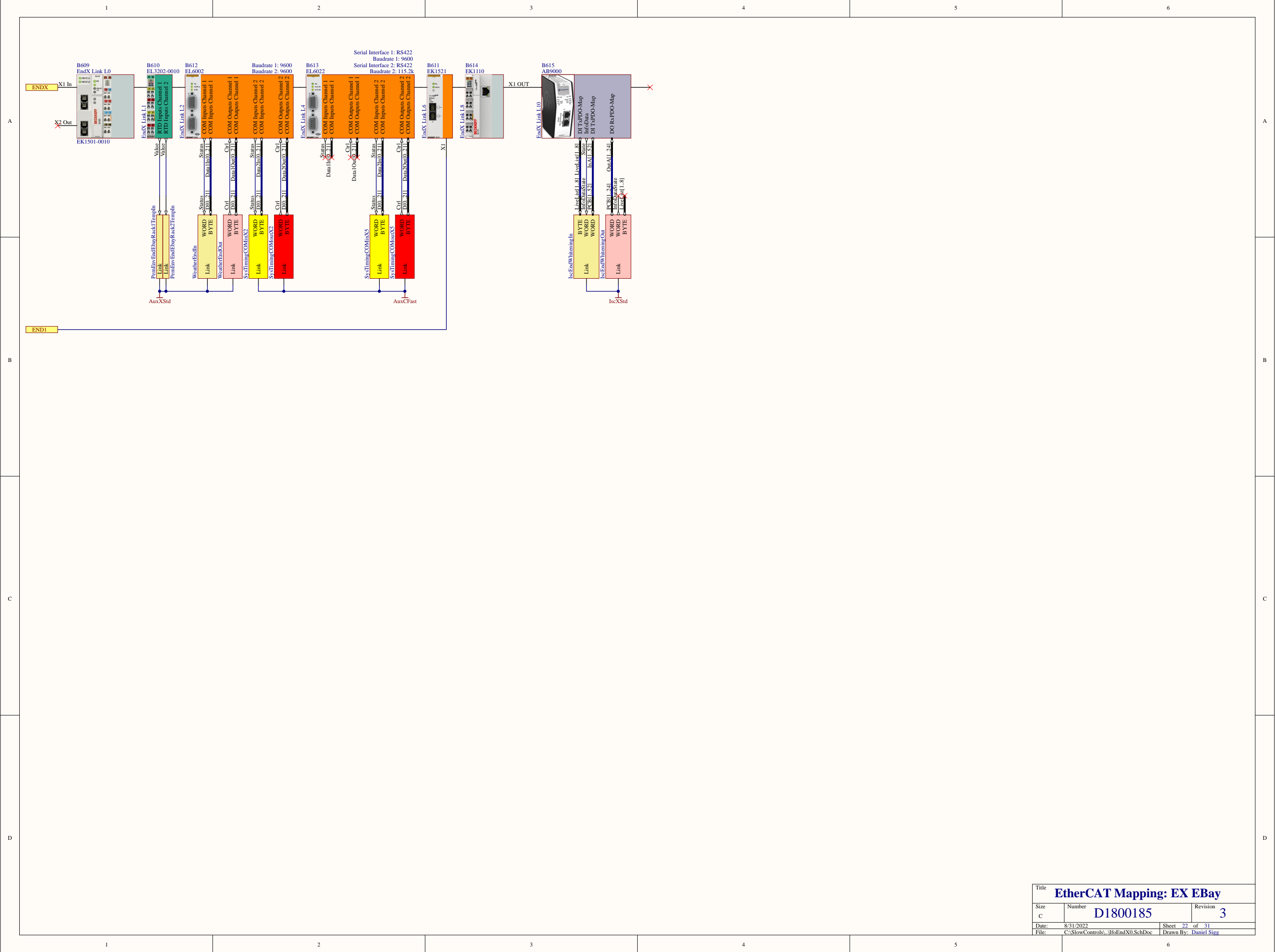

Title EtherCAT Mapping: EX EBay		
Size c	Number D1800185	Revision 3
Date:	8/31/2022	Sheet 22 of 31
File:	C:\SlowControls\...ifoEndX0.SchDoc	Drawn By: Daniel Sigg

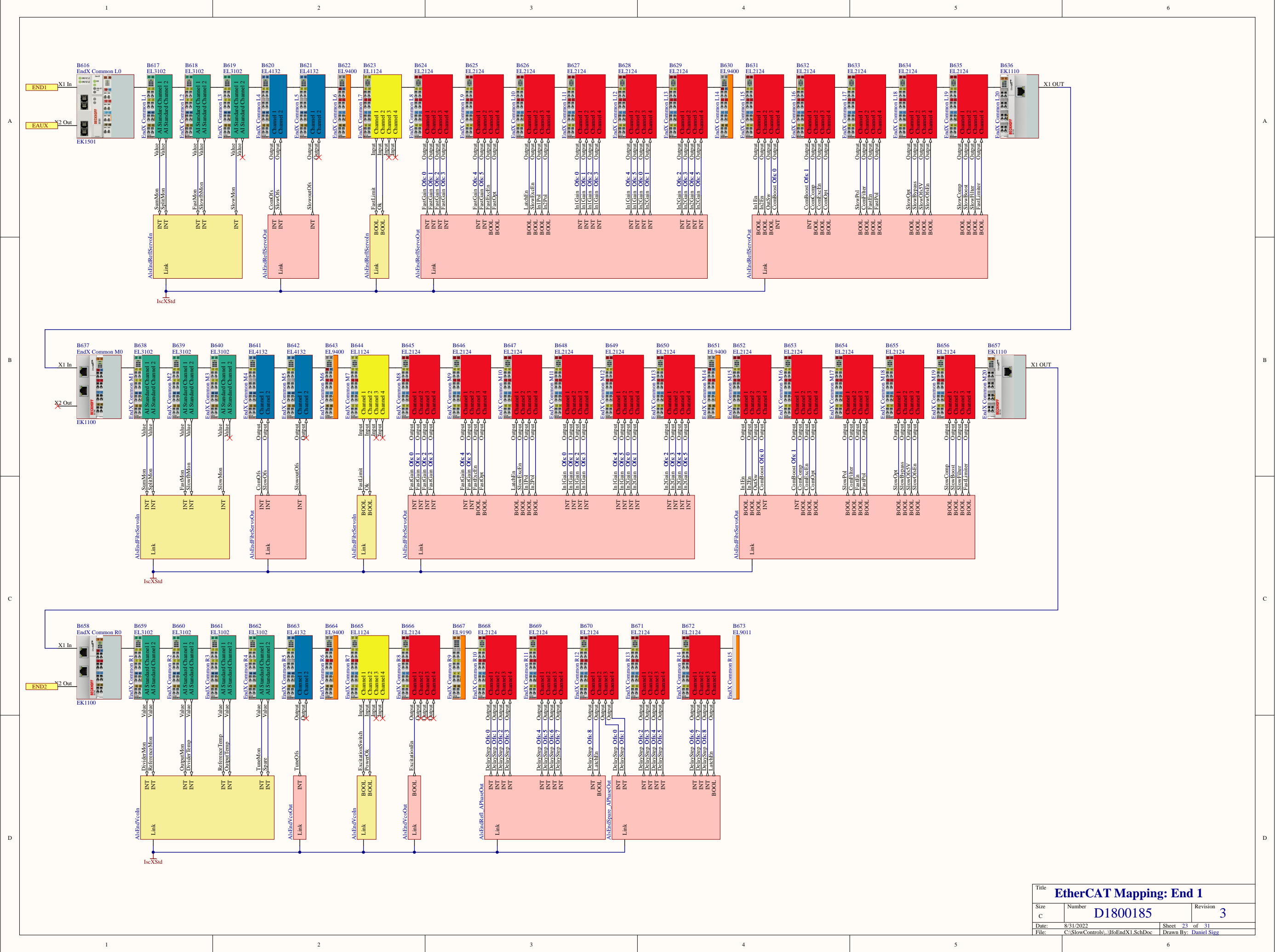

Title EtherCAT Mapping: End 1		
Size	Number	Revision
c	D1800185	3
Date:	8/31/2022	Sheet 23 of 31
File:	C:\SlowControls\..._lfoEndX1_SchDoc Drawn By: Daniel Sig	

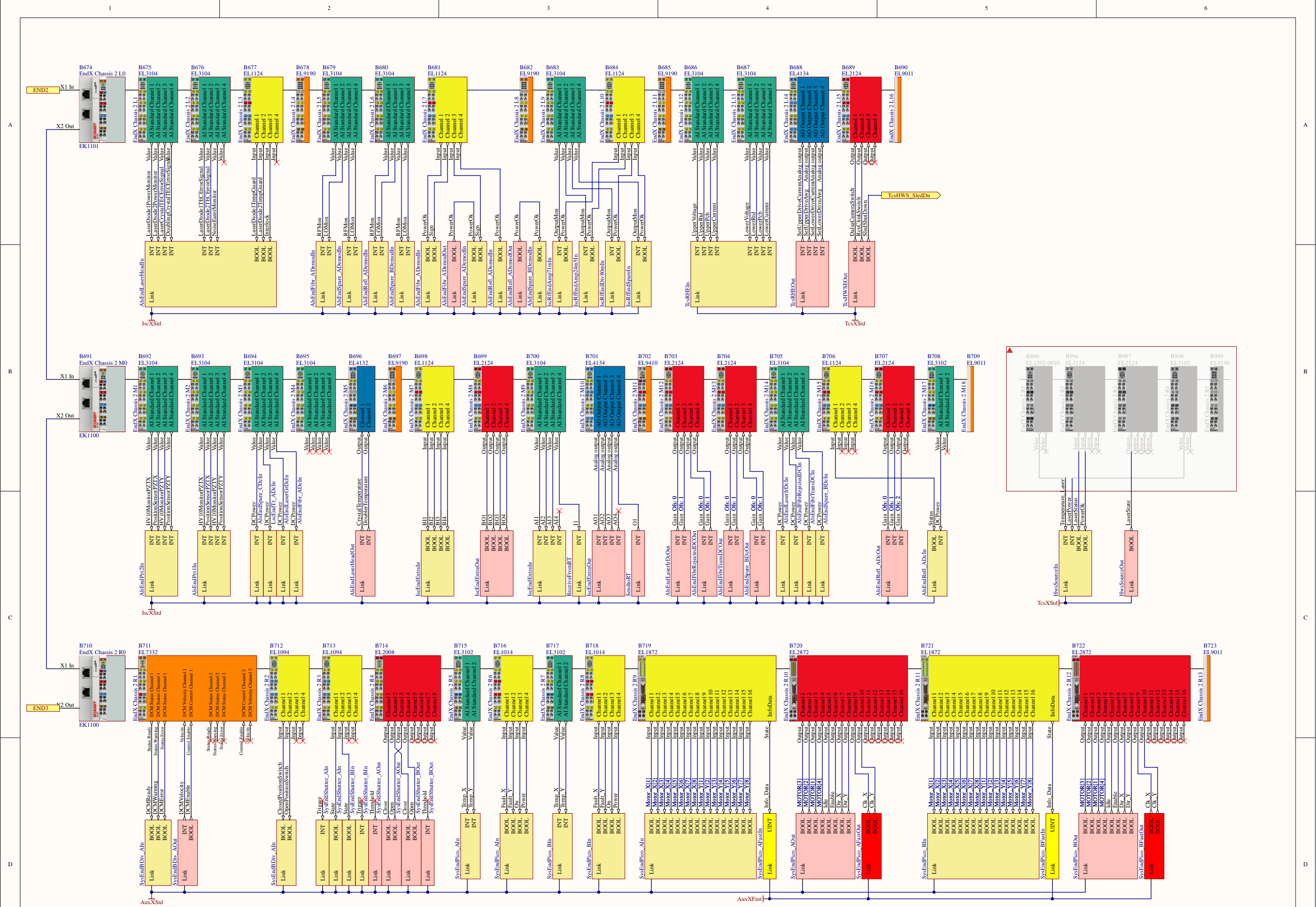

Title EtherCAT Mapping: End 2		
Size	Number	Revision
c	D1800185	3
Date:	8/31/2022	Sheet 24 of 31
File:	C:\SlowControls\...lfoEndX2.SchDoc	Drawn By: Daniel Sig

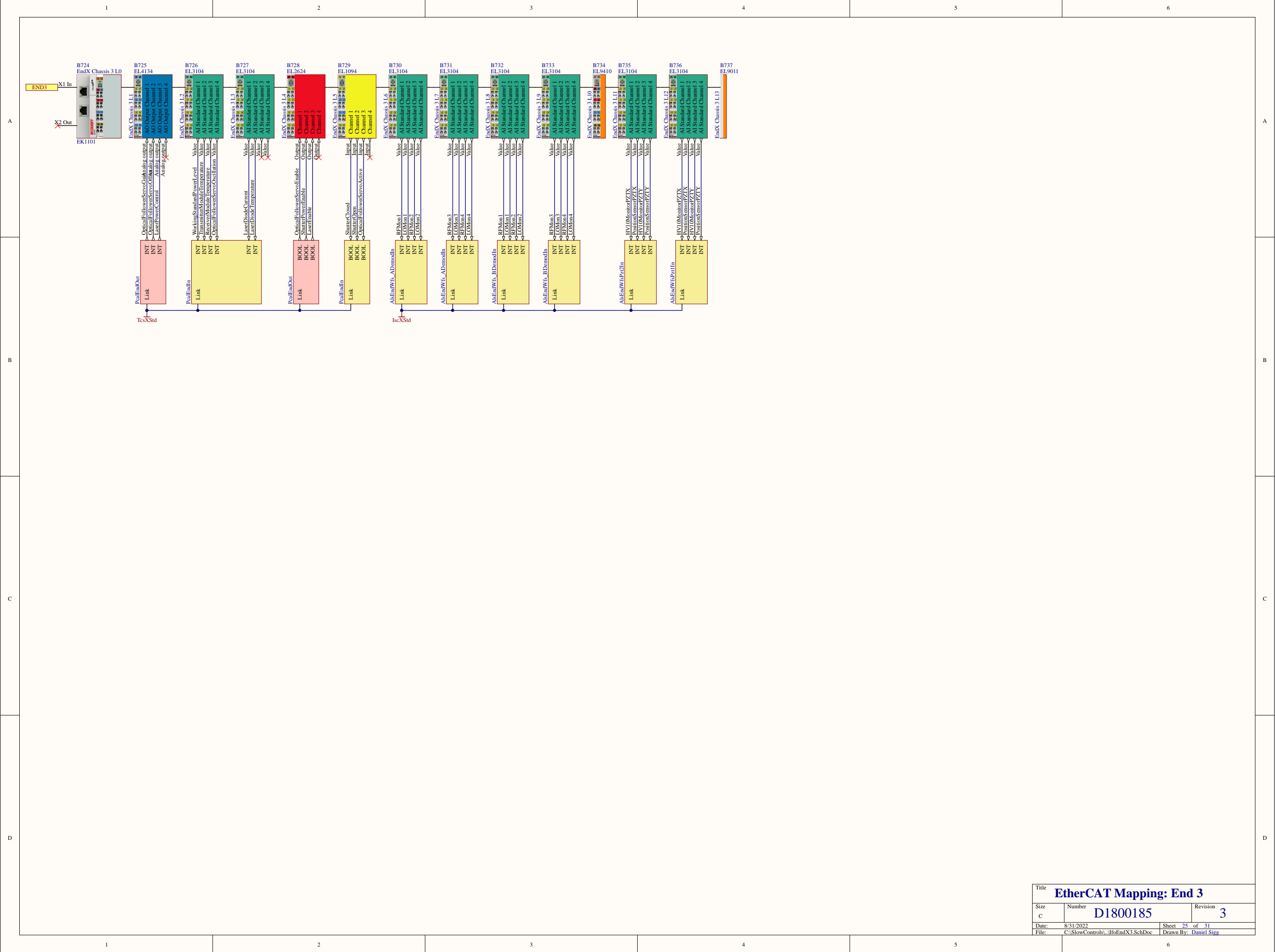

Title		
EtherCAT Mapping: End 3		
Size	Number	Revision
c	D1800185	3
Date:	8/31/2022	Sheet 25 of 31
File:	C:\SlowControls\...ifoEndX3.SchDoc	Drawn By: Daniel Sigga

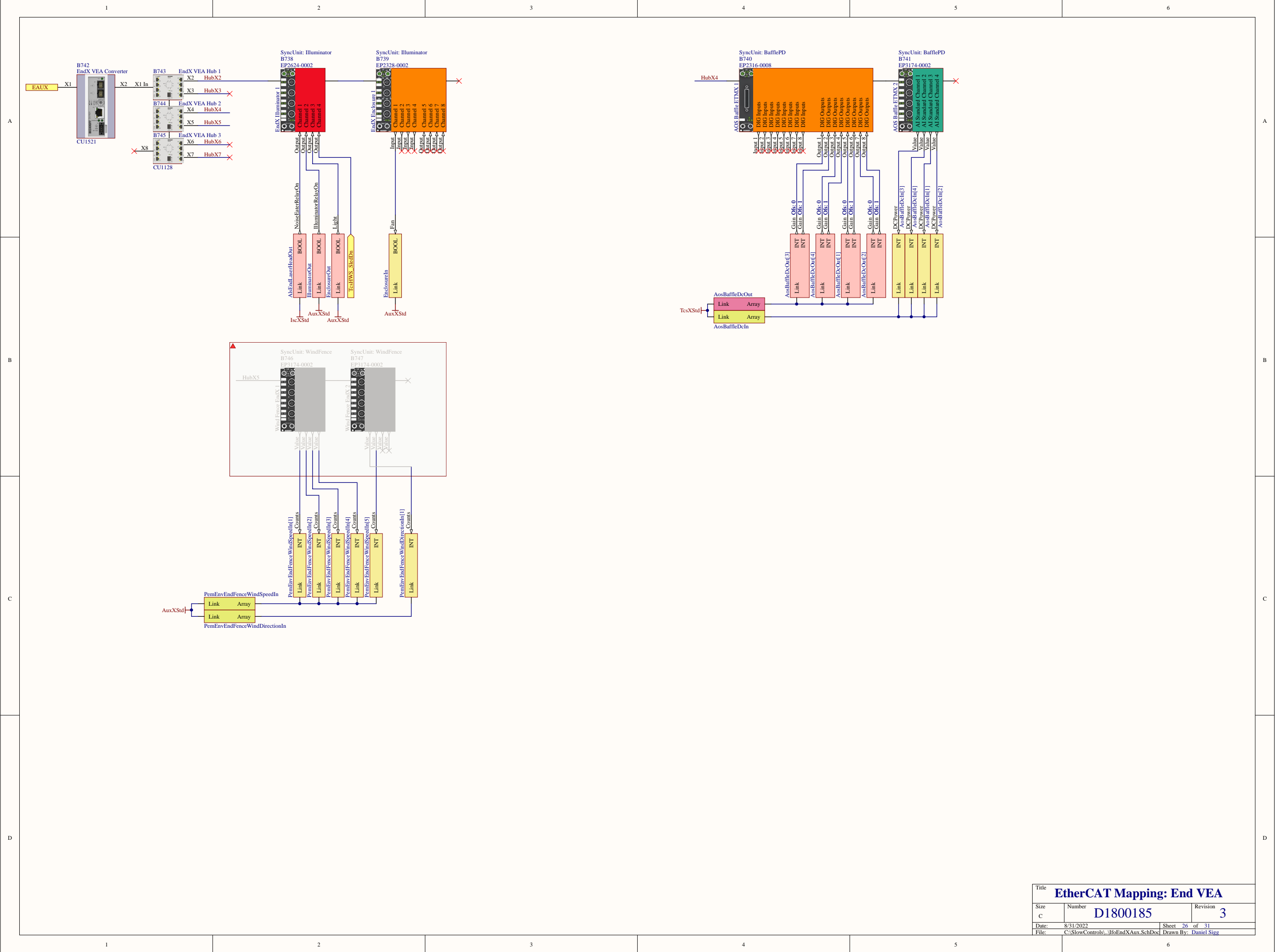

Title EtherCAT Mapping: End VEA		
Size	Number	Revision
c	D1800185	3
Date:	8/31/2022	Sheet 26 of 31
File:	C:\SlowControls\...ifoEndXAux.SchDoc Drawn By: Daniel Sigga	

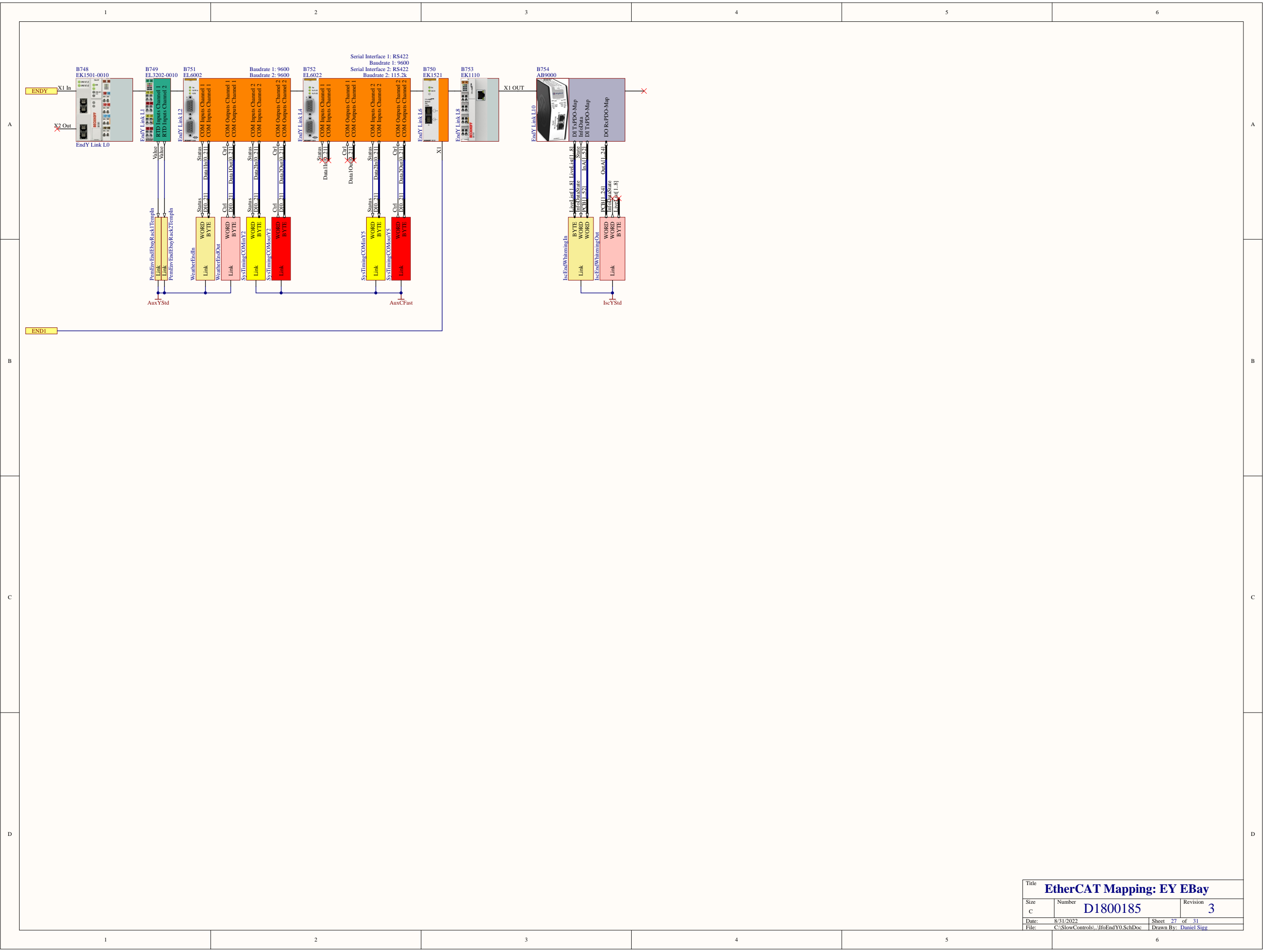

Title			EtherCAT Mapping: EY EBay		
Size	Number	Revision		3	
c	D1800185				
Date:	8/31/2022	Sheet	27	of	31
File:	C:\SlowControls\...ifoEndY0.SchDoc	Drawn By:	Daniel Sigg		

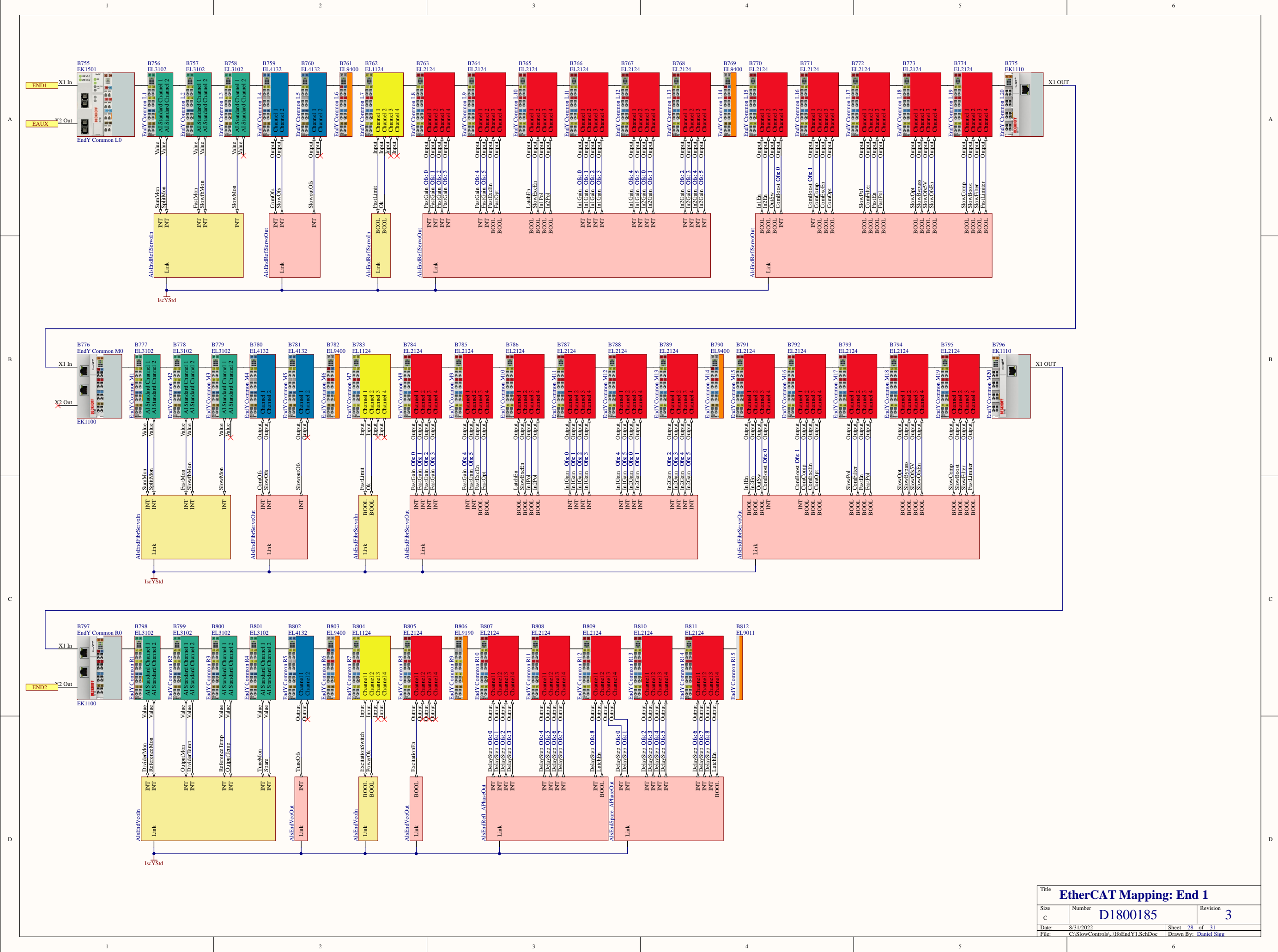

Title		
EtherCAT Mapping: End 1		
Size	Number	Revision
c	D1800185	3
Date:	8/31/2022	Sheet 28 of 31
File:	C:\SlowControls\...ifoEndY1.SchDoc	Drawn By: Daniel Sig

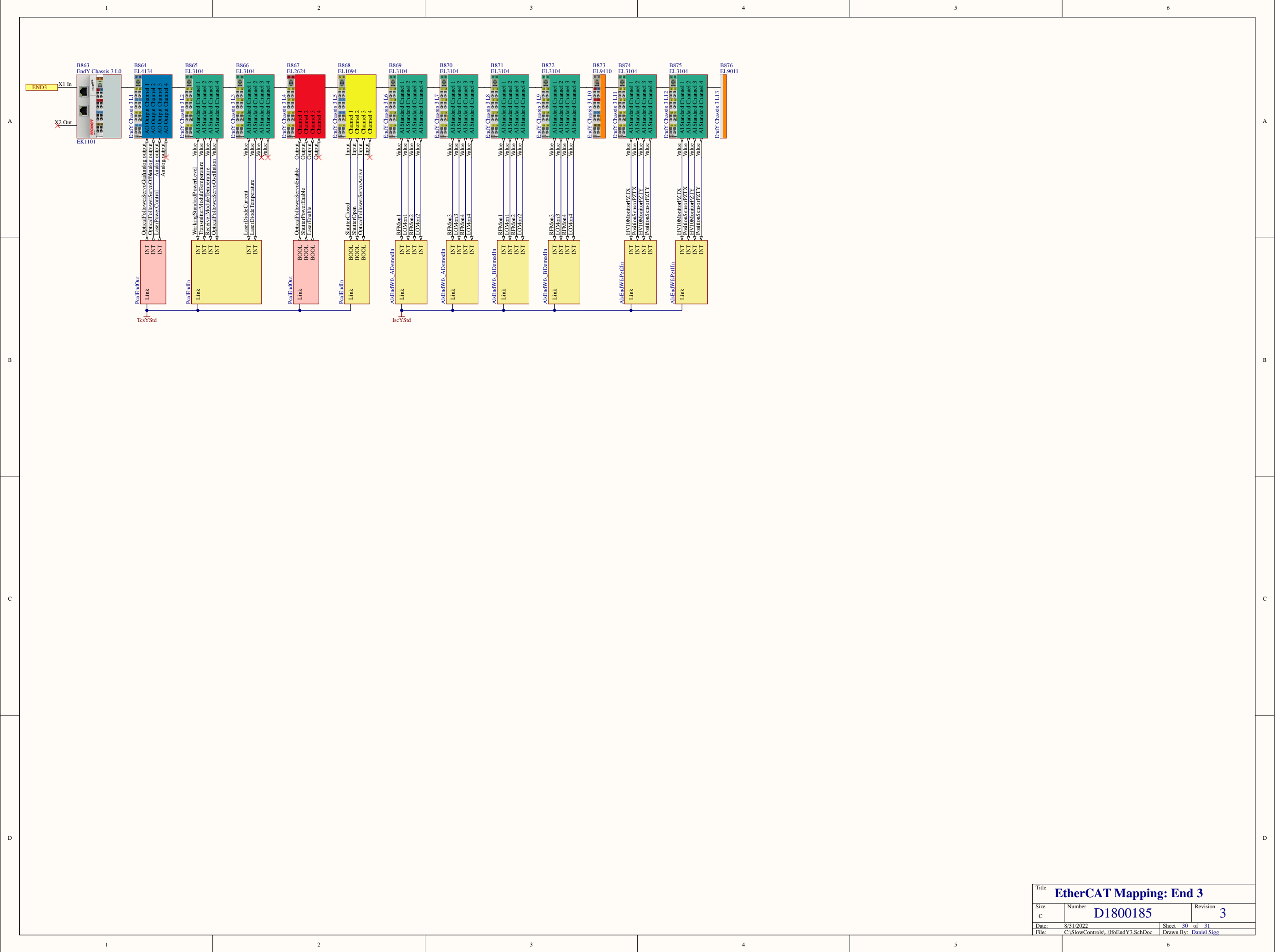

Title		EtherCAT Mapping: End 3	
Size	Number	Revision	
c	D1800185	3	
Date:	8/31/2022	Sheet 30 of 31	
File:	C:\SlowControls\...ifoEndY3.SchDoc	Drawn By:	Daniel Sigga

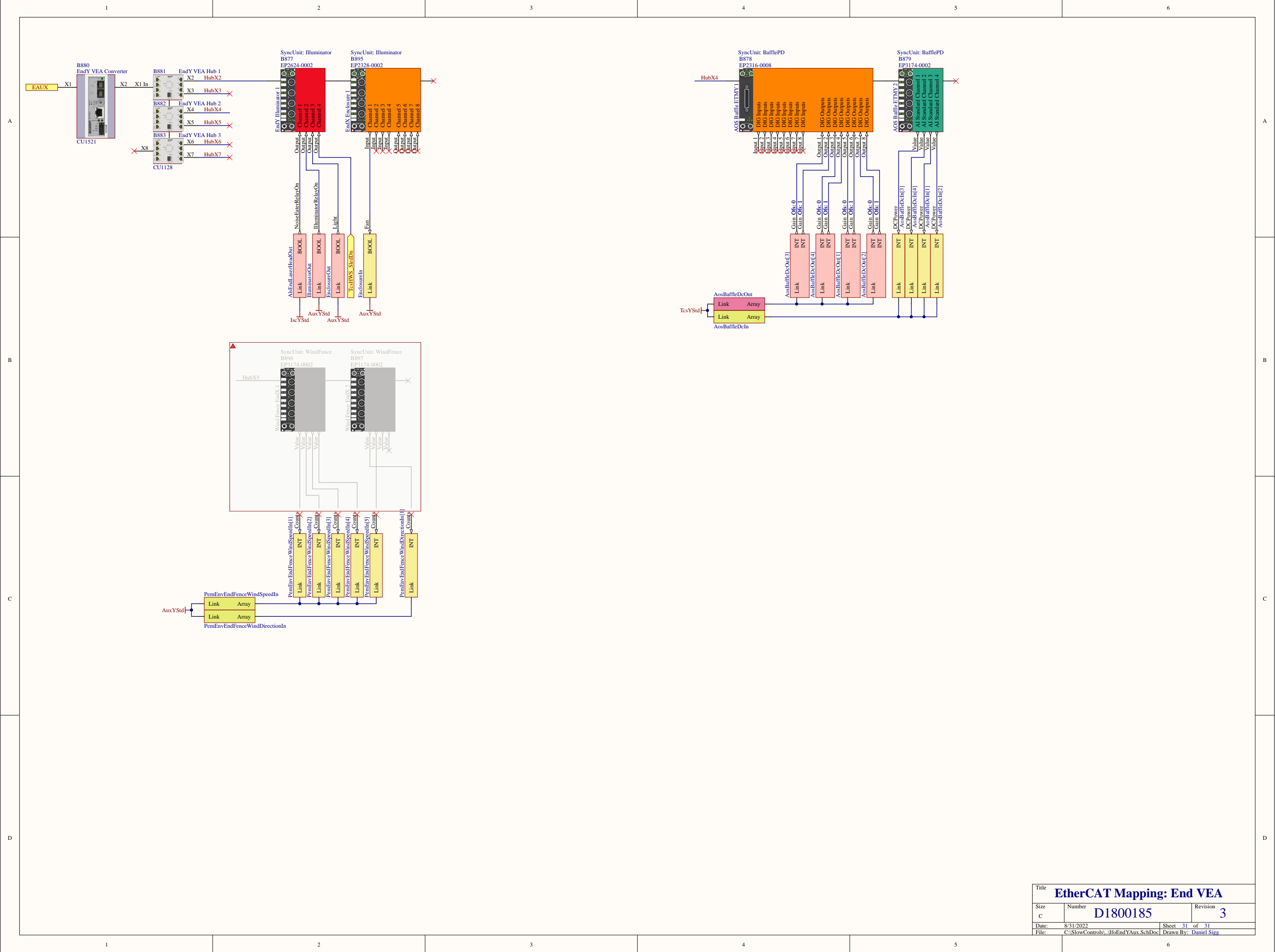

Title			EtherCAT Mapping: End VEA
Size	Number	Revision	
c	D1800185	3	
Date:	8/31/2022	Sheet	31 of 31
File:	C:\SlowControls\...ifoEndYAux.SchDoc	Drawn By:	Daniel Sigga