



LIGO–Virgo–KAGRA webinar

Update on the LIGO, Virgo, and KAGRA detector upgrades for O4

28 April 2022

Update on the LIGO, Virgo, and KAGRA detector upgrades for O4



1. Speaker

Anamaria Effler
Scientist
LIGO Livingston
Louisiana, USA



3. Speaker

Yoichi Aso
Associate Professor
National Astronomical
Observatory of Japan



2. Speaker

Matteo Tacca
Researcher
Nikhef, Amsterdam,
The Netherlands



4. Speaker

Patrick Brady
University of Wisconsin-Milwaukee
LSC Spokesperson



Moderation: Alessio Rocchi (INFN Roma Tor Vergata, Italy)

Panelists: Peter Fritschel (MIT, Cambridge, USA)
Yuta Michimura (Caltech, USA / RESCEU UTokyo, Japan)
Michal Was (LAPP/IN2P3, Annecy, France)

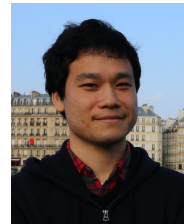

LIGO-Virgo-KAGRA Observing Runs



Observing runs

- O4
 - Expect to start 15 Dec 2022.
 - 1 year with 1 month, mid-run commissioning break.
 - Alerts may be released during engineering running that precedes O4.
 - May extend the run if scheduling O5-upgrades makes that viable.
- Beyond O4
 - O5 schedule is tentative.
 - Post-O5 plans are being developed; observations will continue (subject to funding)

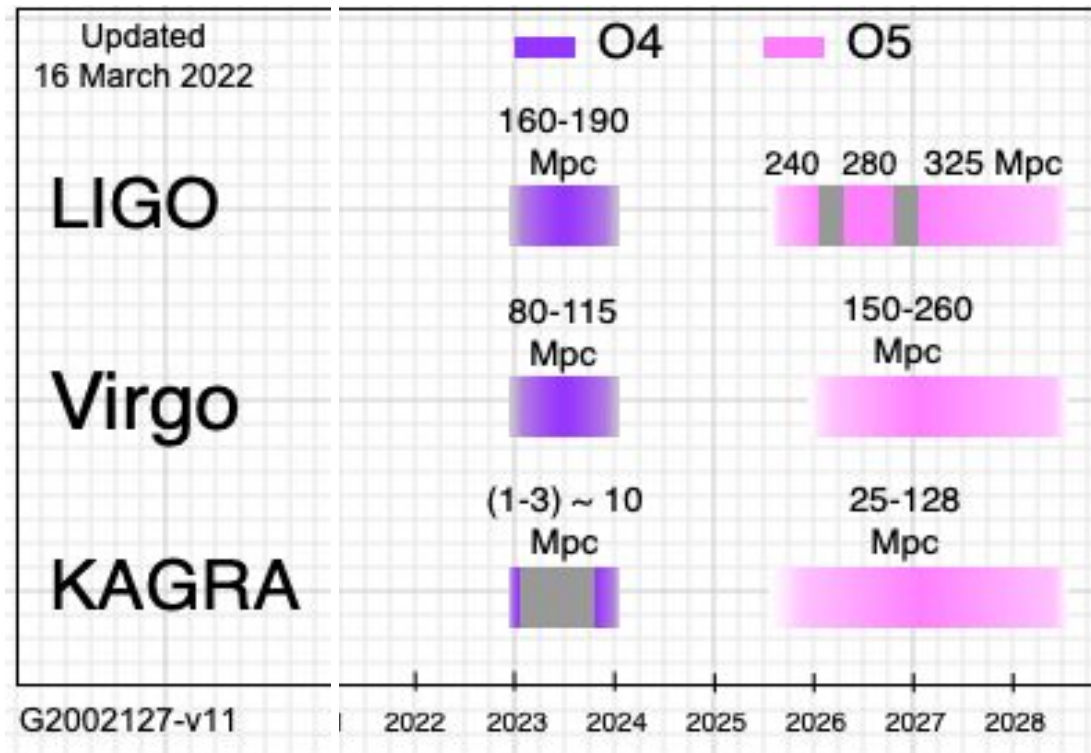

Run planning framework



- LVK will continue to review observing run plans quarterly
 - a. Will update public pages to indicate the information is current.
- Restart OpenLV(K)EM meetings in preparation for O4.
 - a. The webinar today provides an update on the LIGO, Virgo, and KAGRA detector upgrades for O4 and briefly outlines the O4 & O5 run plans.
 - b. Organize virtual town hall meetings starting in May or June to present technical information about alert distribution and to hear from groups with plans to use these alerts:
 - 4-6 meetings between now and start of O4
 - Roughly monthly meetings for updates and conversations during O4 (as in O3).
 - We will also discuss run duration to the extent that there is flexibility.
- Topics for future meetings
 - a. Establish a common location for information about active and proposed MMA projects
 - b. Adopt or establish a workshop related to coordination of active and proposed MMA projects
 - c. Trade-offs in O5 and post-O5 plans.

LIGO O4 Upgrades



Summary of LIGO Improvement Goals



- **400kW circulating arm power**
(compare to ~200 kW in O3)
- **Squeezed light efficacy 4.5dB**
(compare to 2-3dB in O3)
- **300m filter cavity** for frequency dependent squeezing
- **Low frequency technical noise reduction**
<100 Hz

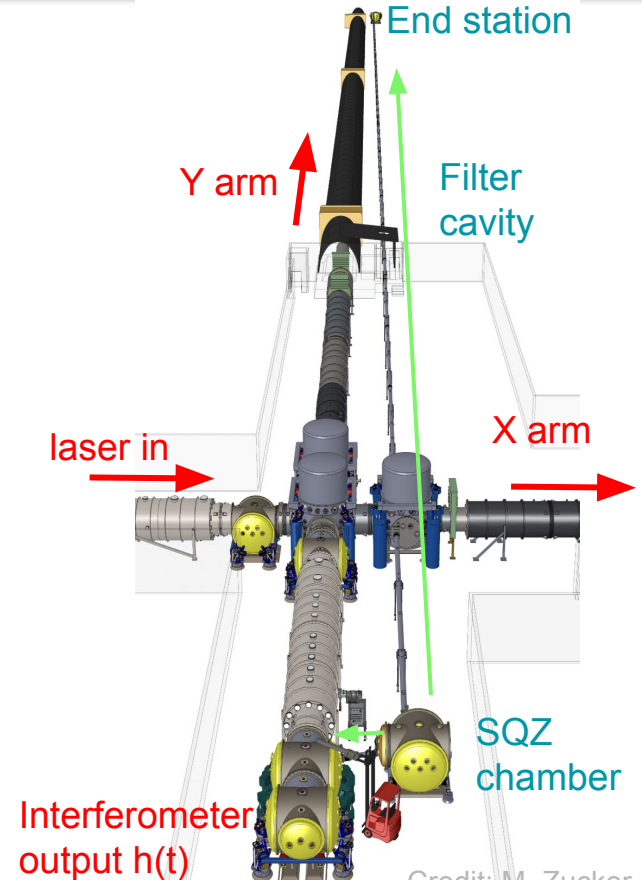

Potential Resulting Sensitivity

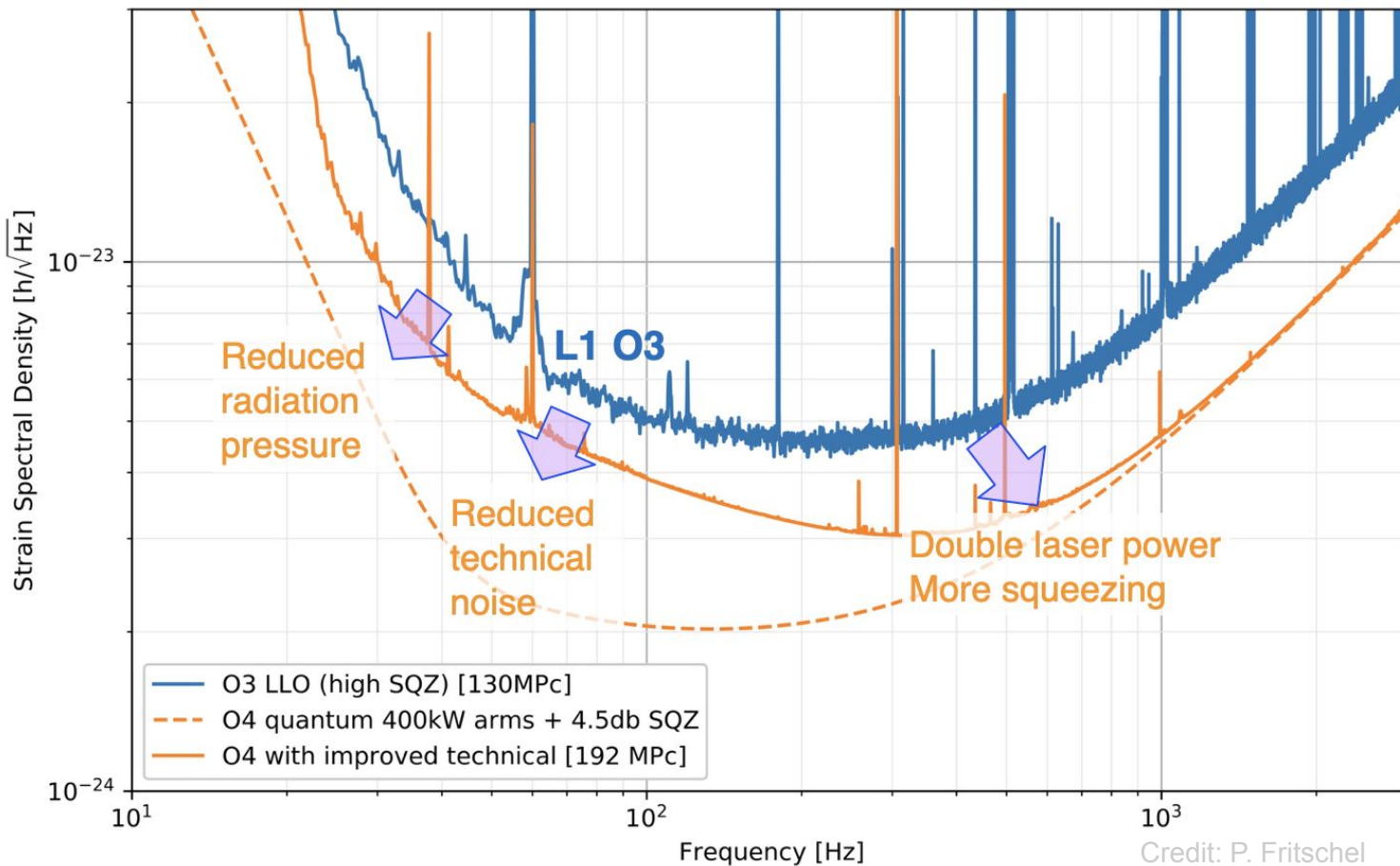

$h \sim 1/r$

rate $\sim r^3 * T$

Reduce Quantum Noise: Double arm power to 400 kW

- Higher power laser (complete rebuild)
- Better test masses (point absorber issues)
 - One input test mass at H1
 - Both end test mass at L1

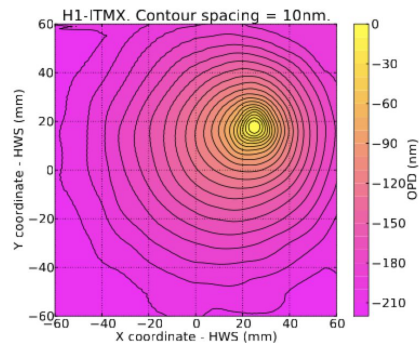

FIG. 2. Optical path distortion from a single point absorber on H1-ITMX. *Fit the absorber power for this example.*

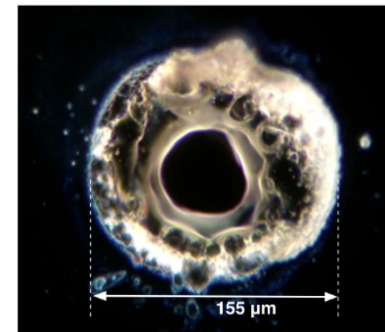

FIG. 4. Dark field microscope image of point absorber measured on an Advanced LIGO optic (corresponding to the thermal lens measurement shown in Figure 2). Also shown in Buikema et al. [1].

[A. Brooks et al](#)

Point absorbers effectively cause losses in the arms such that an arm power increase no longer translates to improved sensitivity;

Working with vendor to eliminate them;

The reason we have to change test masses.

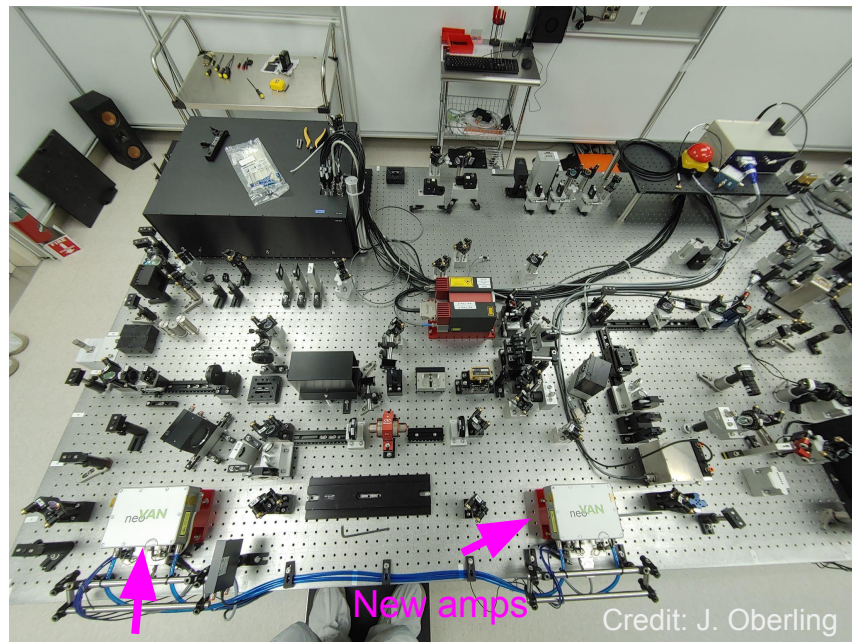

Credit: J. Oberling

Reduce Quantum Noise: Freq. dependent (more) squeezing

- 300m filter cavity -> also squeeze at low frequency!
- Better Faraday Isolators with lower losses
- Active mode matching

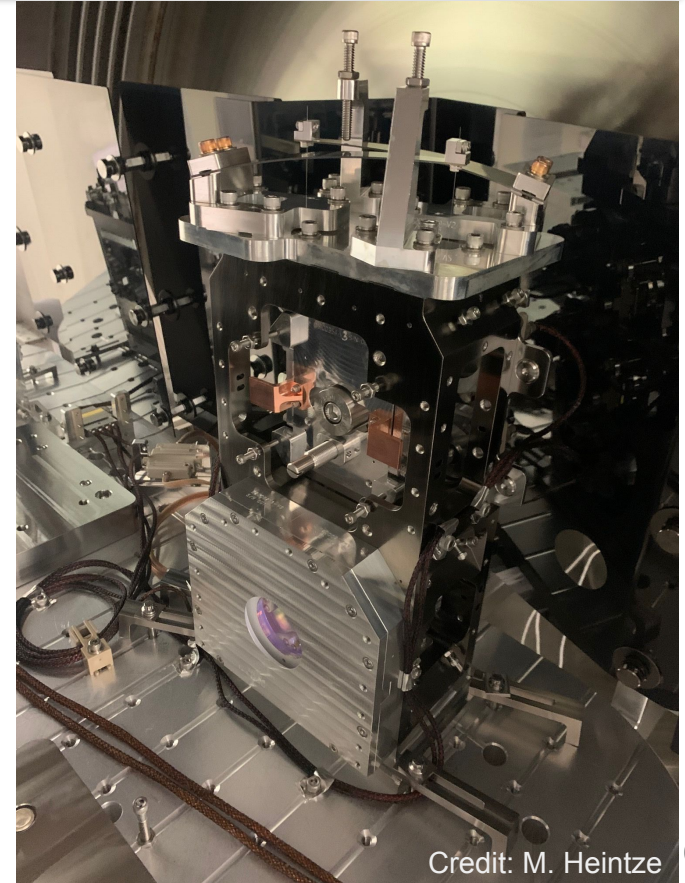
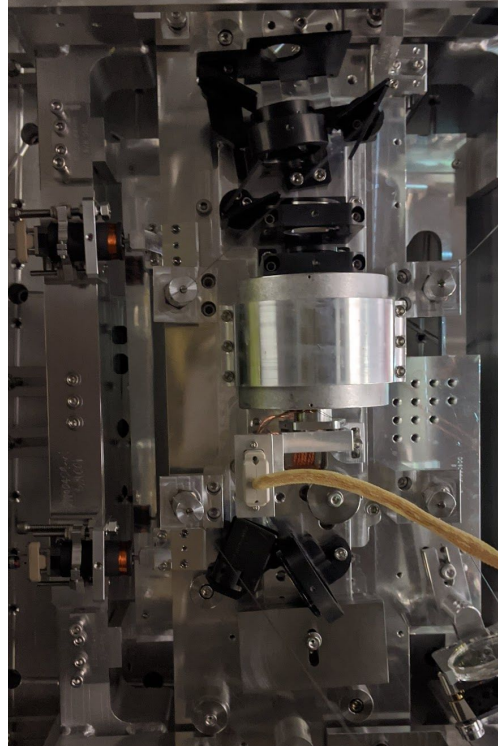

Reduce low frequency tech. noise

- Scattered light reduction
 - More baffling
 - Removal of output wedged window
 - Damping of highQ resonances of scattering surfaces
- Control noise reduction / subtraction
- Better electronics

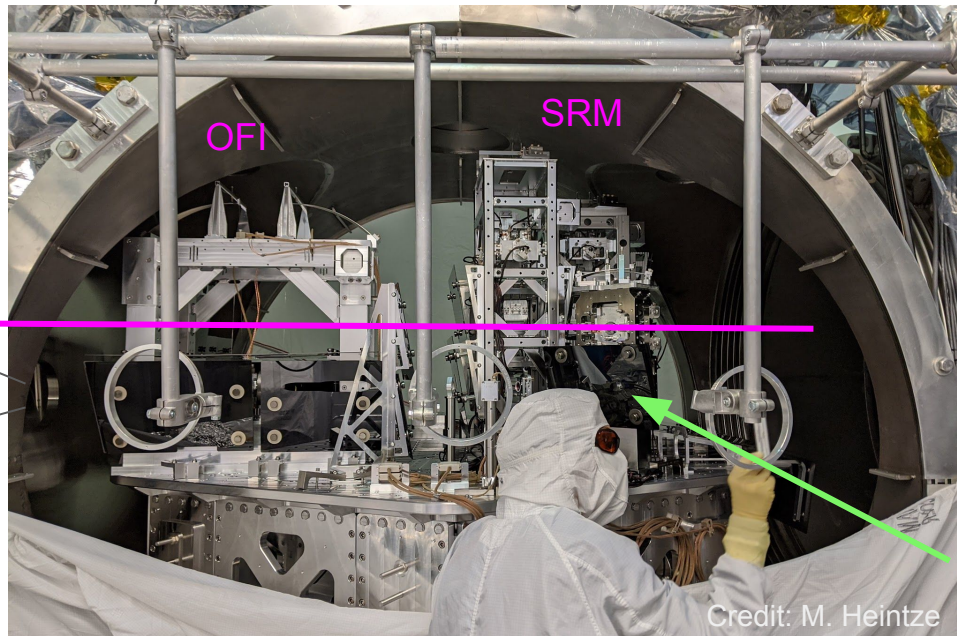
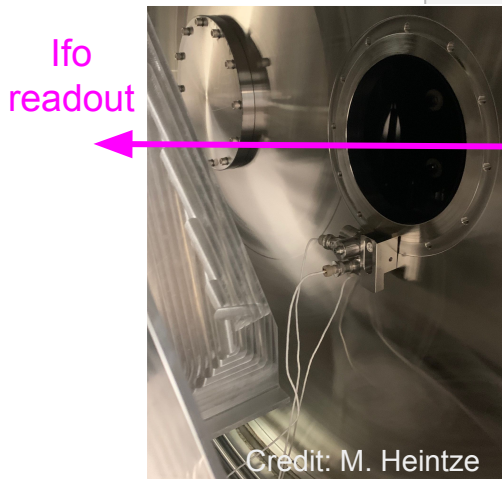
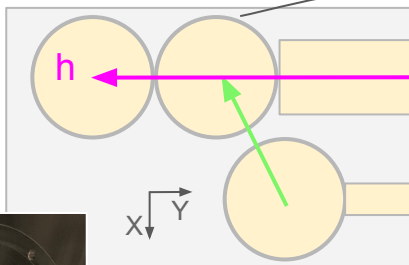
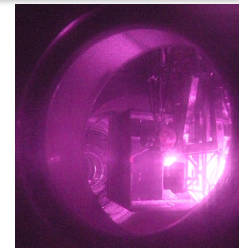

Duty cycle improvements

- Damping of high Q resonances of suspensions:
 - Violin modes ~ 500 Hz
 - Beam Splitter bounce and roll modes: $\sim 16, 24$ Hz

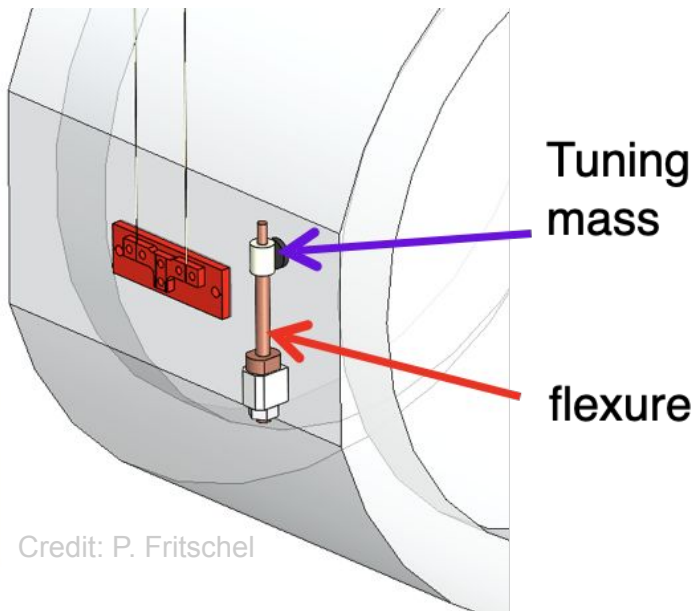

O3b duty cycle: $\sim 75\%$, $\sim 50\%$ triple coverage
(very hard to get above 85% per instrument)

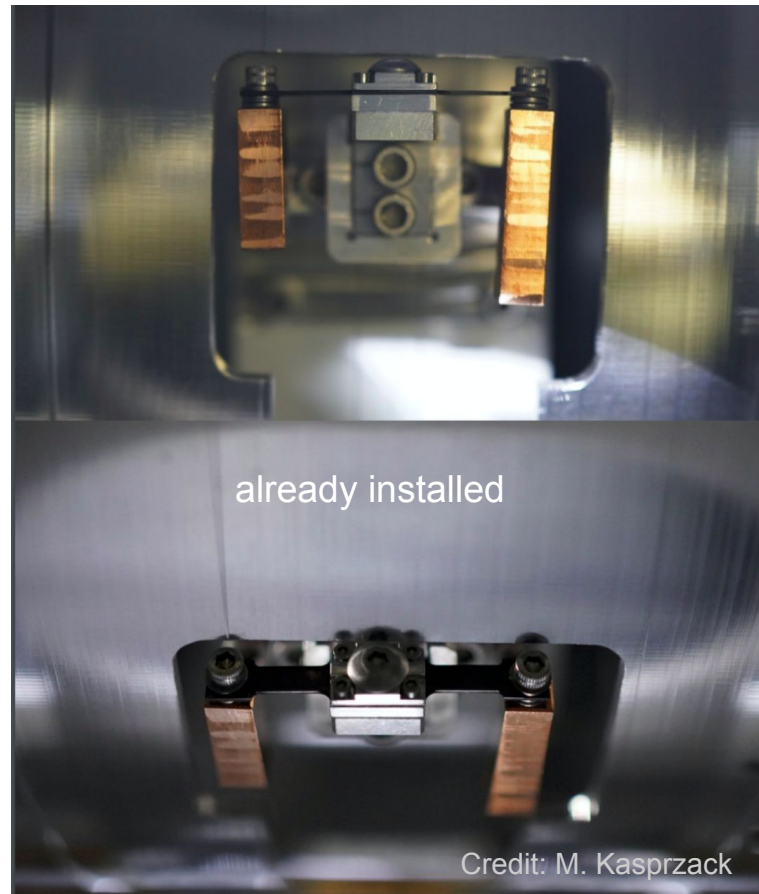

LIGO: Approximate schedule



O4 currently projected to begin mid December 2022

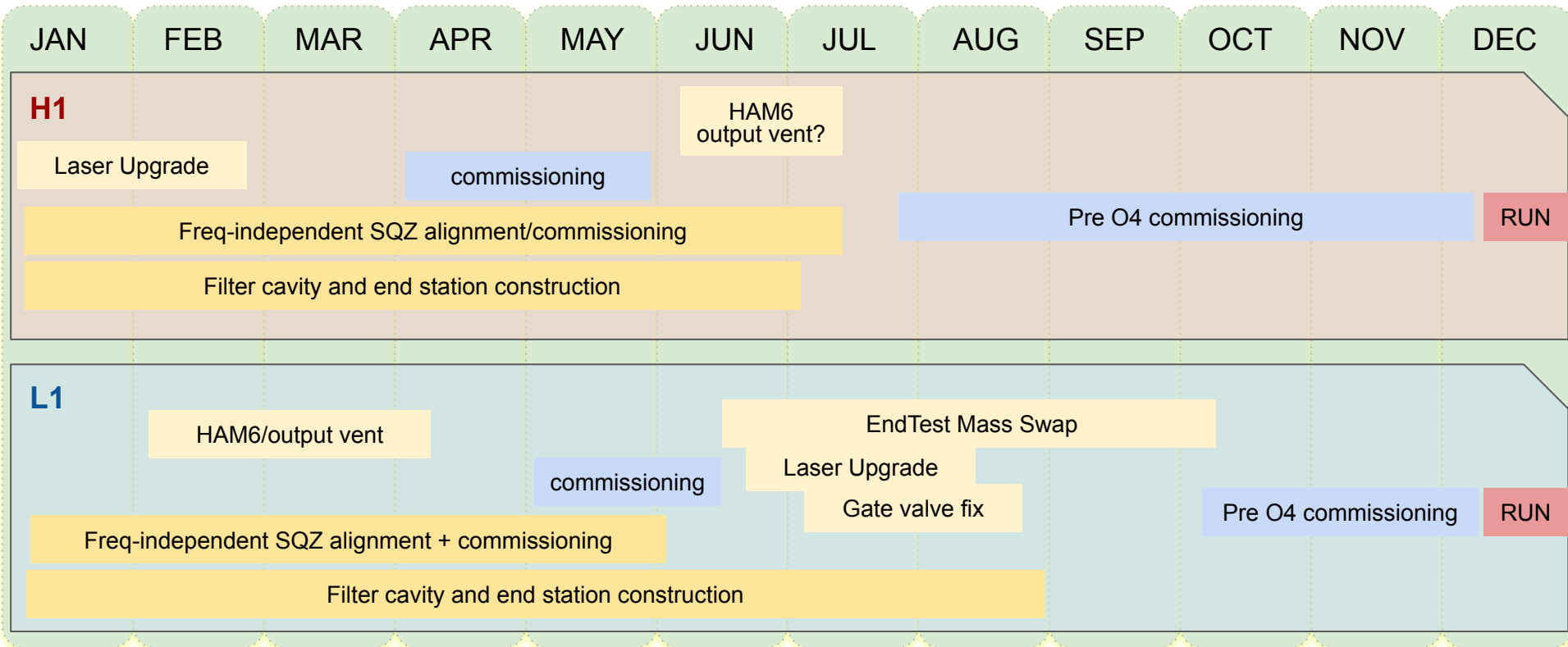

** “Pre O4 commissioning” means ALL subsystems, including data processing (eg alerts, etc)

Potential Resulting LIGO Sensitivity

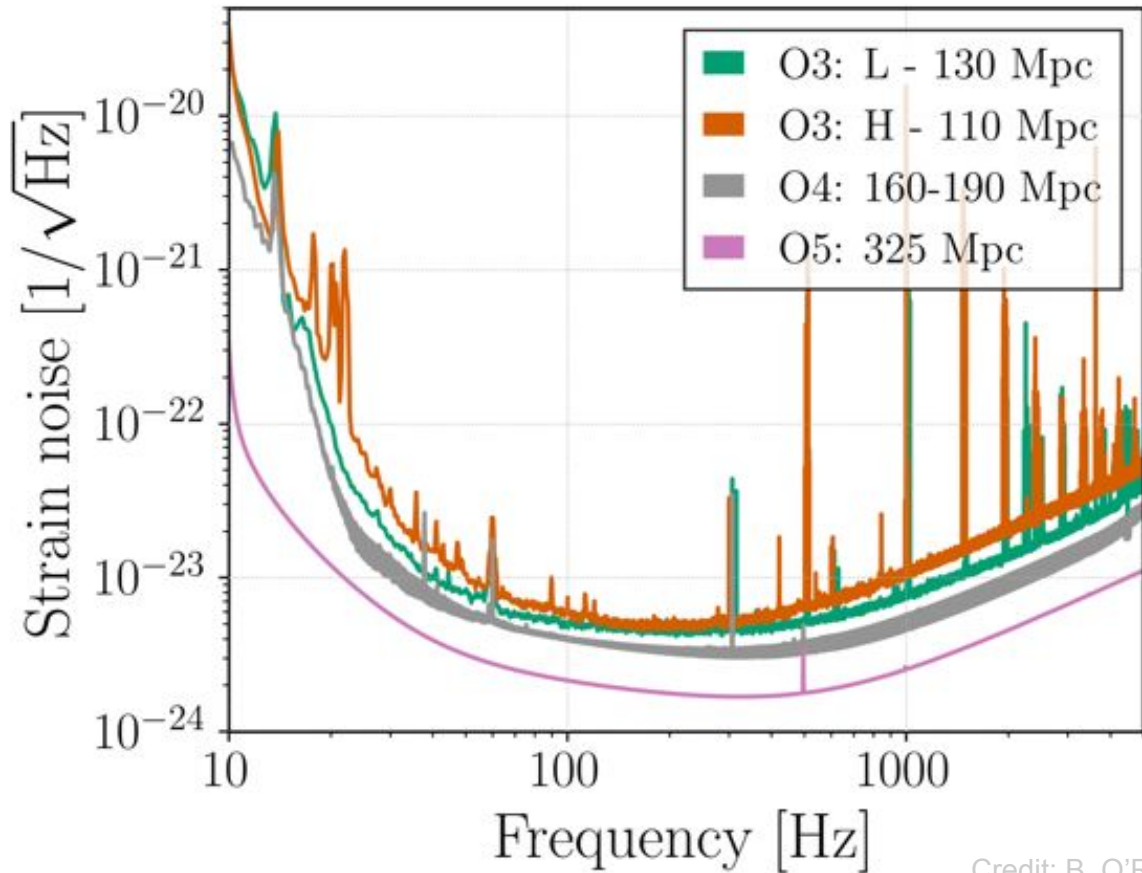

$$h \sim 1/r$$

$$\text{rate} \sim r^3 * T$$

Uncertainties:

- will new mirror be free of defects?
- will we get the expected technical noise reduction?
- have we abated sufficiently the losses in the whole system to achieve 4.5dB freq. dependent squeezing?

Virgo O4 upgrades



Advanced Virgo Plus for O4

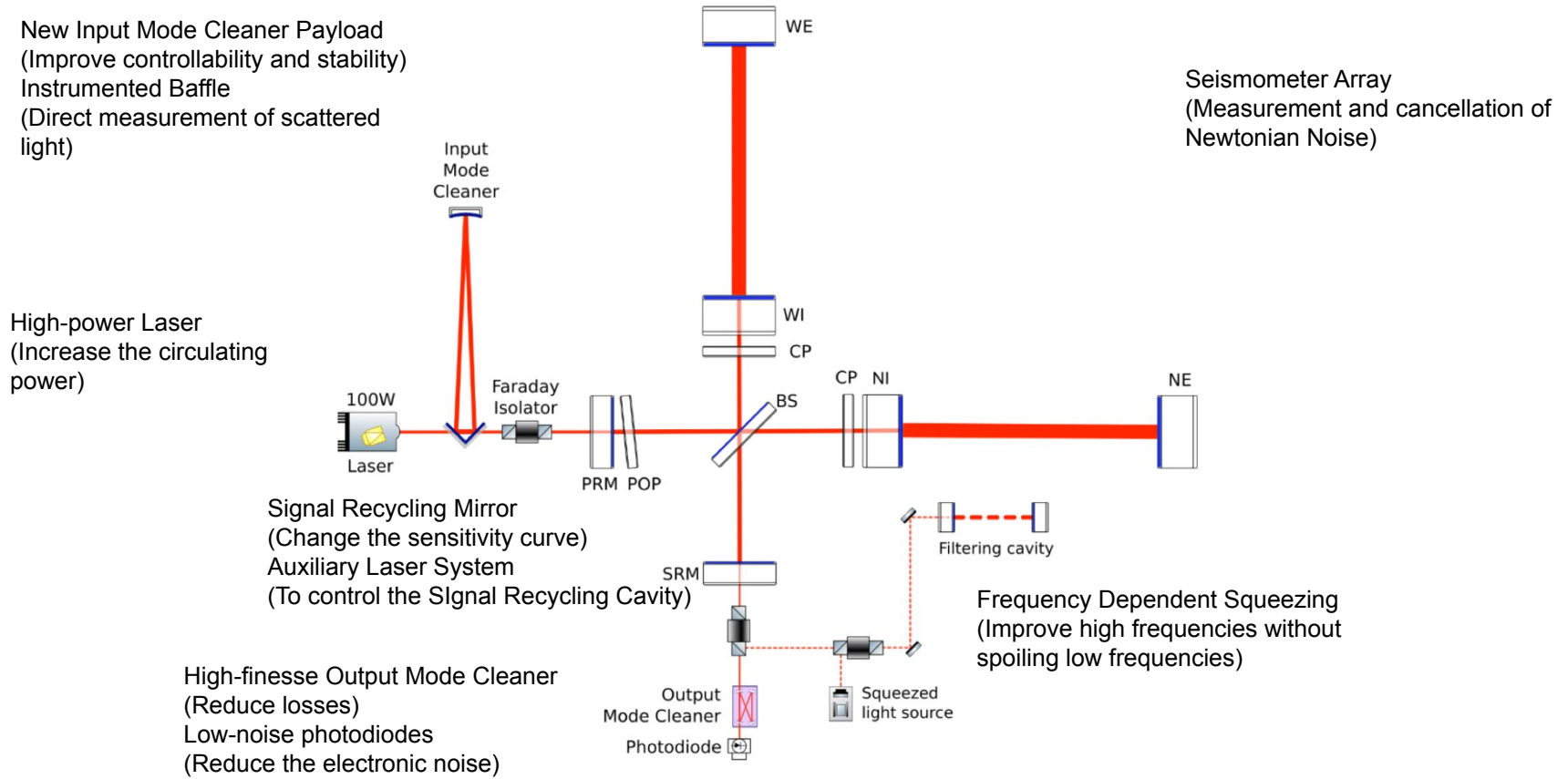

Target Sensitivity Curve

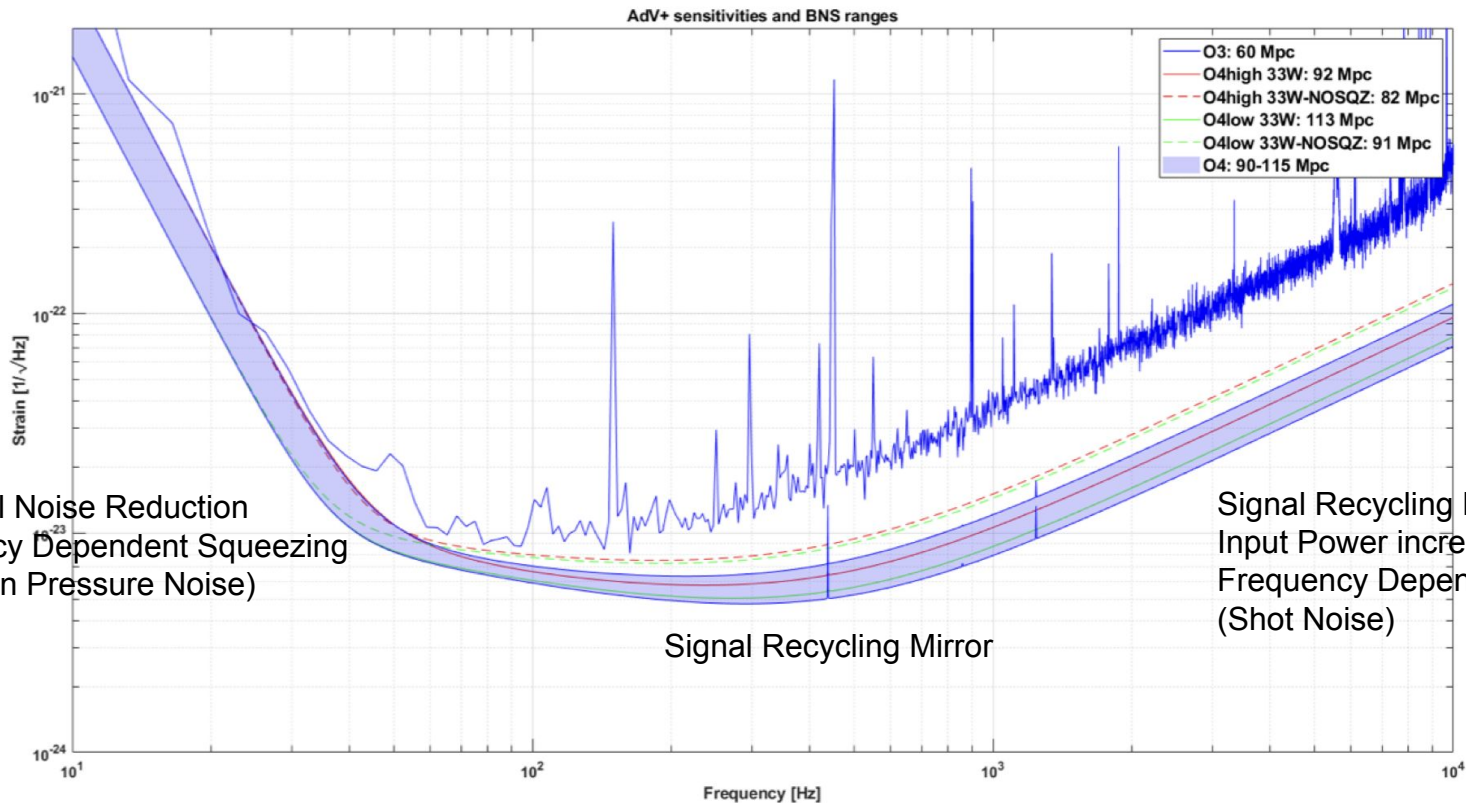

Signal Recycling Mirror & Auxiliary Laser System

Goal for O4: implement the Signal Recycling Cavity to change the shape of the sensitivity curve -> make it properly working is the most challenging upgrade:

- Installation of a new complete payload (mirror, marionette, thermal actuator, baffles)
- 5 longitudinal degrees of freedom -> installation of the auxiliary laser system to allow the control of the full experiment (same strategy used in LIGO and KAGRA)

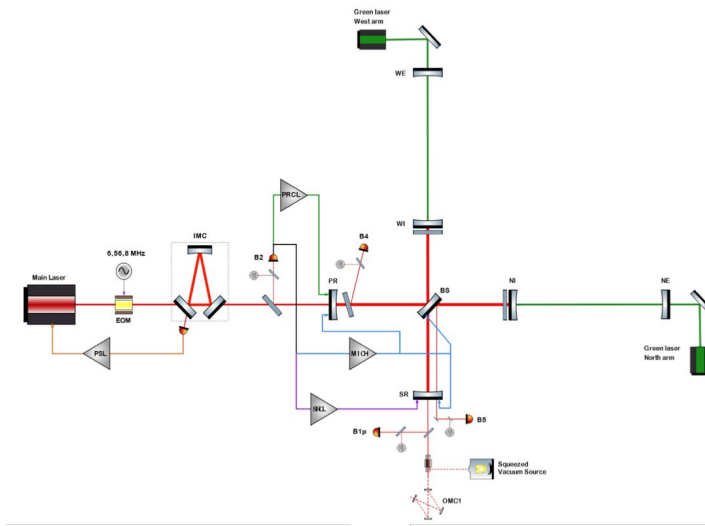
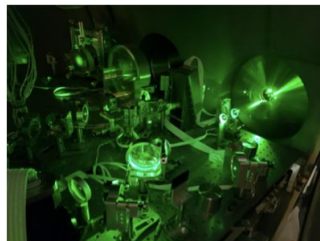
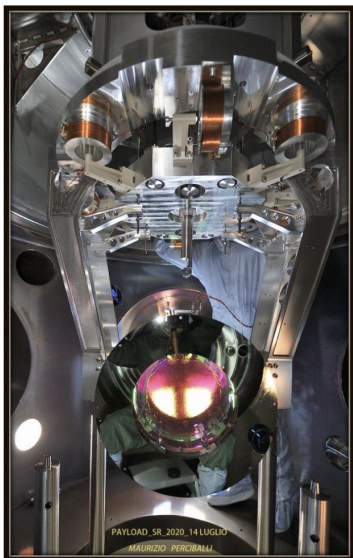

Laser System Upgrade

Goal for O4: power of about 40 W at the input of the interferometer -> power of about 200 kW circulating in the arm cavities:

- 100 W monolithic fibered system -> maximum power of about 75 W injected into the interferometer
- former multi-stage amplification system kept as spare

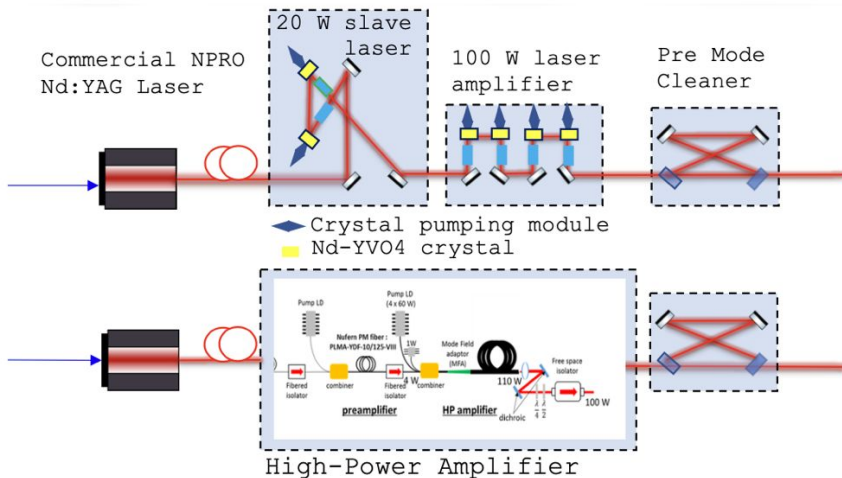

Output Optics System Upgrade

Goal for O4: reduce the losses by a factor 2 at the output of the interferometer, improve the filtering of spurious fields by 1 order of magnitude, mitigation of scattered light impact:

- Installation of a single high-finesse Output Mode Cleaner Cavity
- Installation of baffles, beam dumps and absorbing glasses

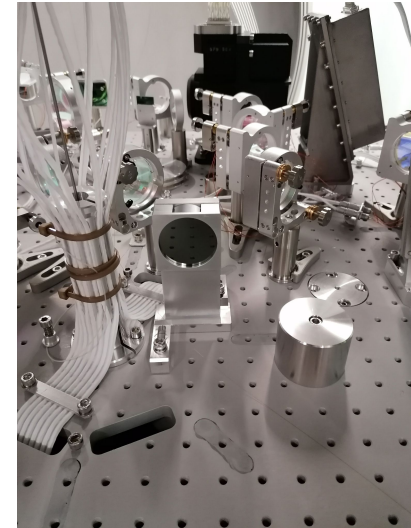
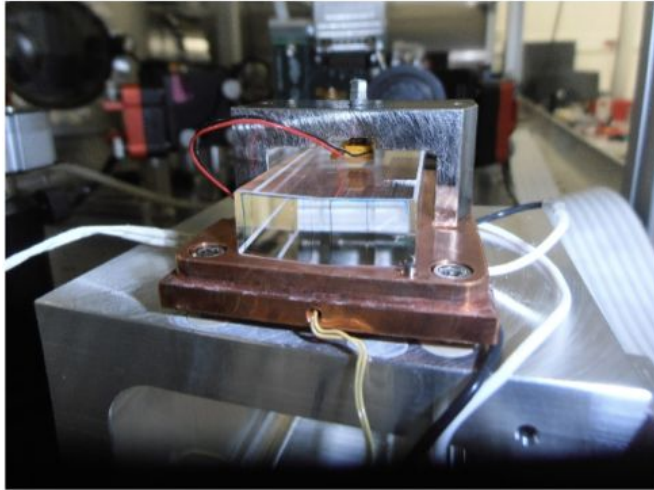

Frequency Dependent Squeezing

Goal for O4: reduce the impact of the shot noise at high frequency without spoiling the low frequency:

- Installation of a Frequency Independent Squeezing source
- Inject the squeezing beam into a filter cavity before sending it into the interferometer

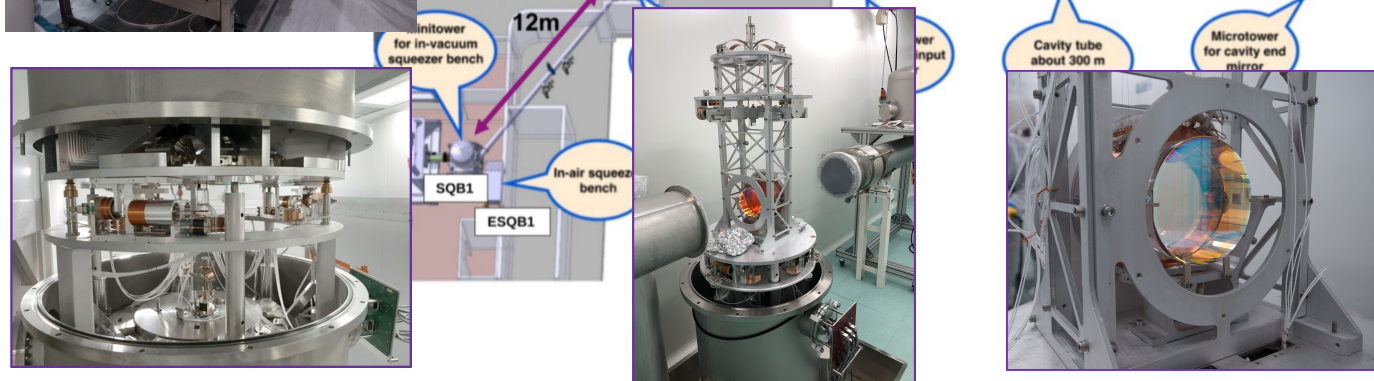
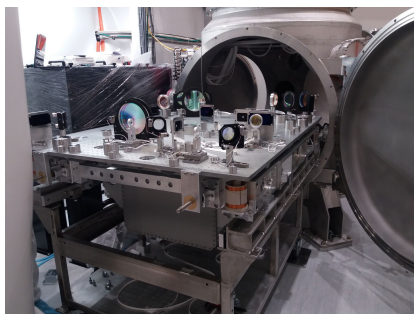

Current Status



- All the major upgrades have been successfully installed
- Power injected into the interferometer about 33 W -> circulating cavity around 140 kW
- Full interferometer controlled is not at an optimal working point -> many indications about the current limitations
- Current main activity on the interferometer: optimization of the working point (mode-matching, global alignment, thermal state tuning)
- Frequency dependent squeezing commissioned in parallel -> frequency dependent squeezing measured around 40 Hz

Next Steps & Approximate Schedule



- Improvement of the interferometer working point: mode matching, global alignment, reduction of the control noise, fine tuning of the thermal state
- Have a repeatable estimation of the sensitivity curve
- Optimization of the frequency dependent squeezing system to improve the stability
- Noise hunting to reduce the impact of the technical noises and improve the sensitivity
- Injection of the frequency dependent squeezing into the interferometer

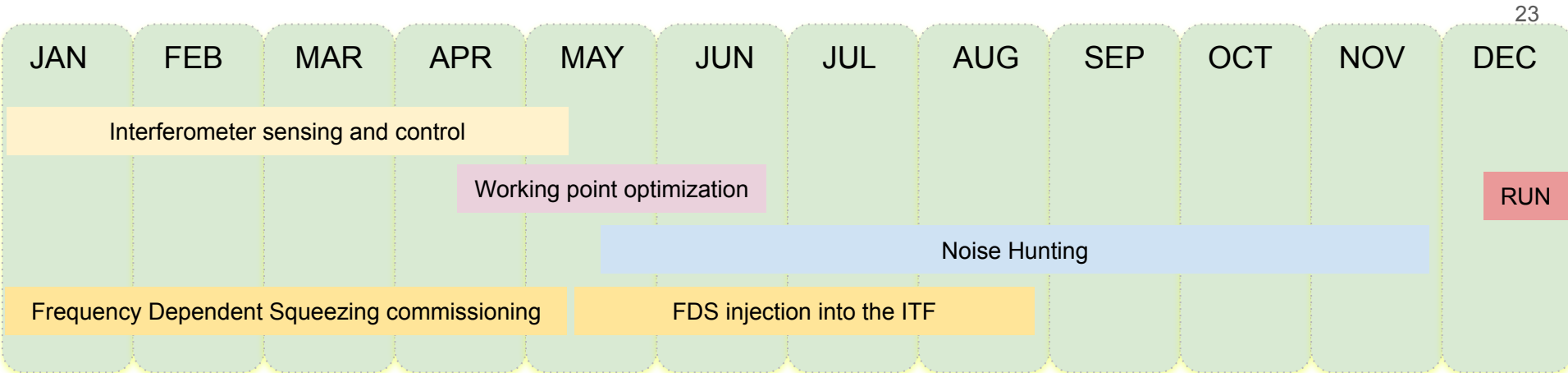

KAGRA O4 upgrades



KAGRA



An underground cryogenic laser-interferometer with 3km arms
Located in Kamioka, Gifu prefecture, Japan



- Project started in 2010
- Initial joint observation in 2020 with GEO600 (O3GK) for 2 weeks
- Best binary range (NS-NS) was about 1Mpc in O3GK

O3GK Noise Budget

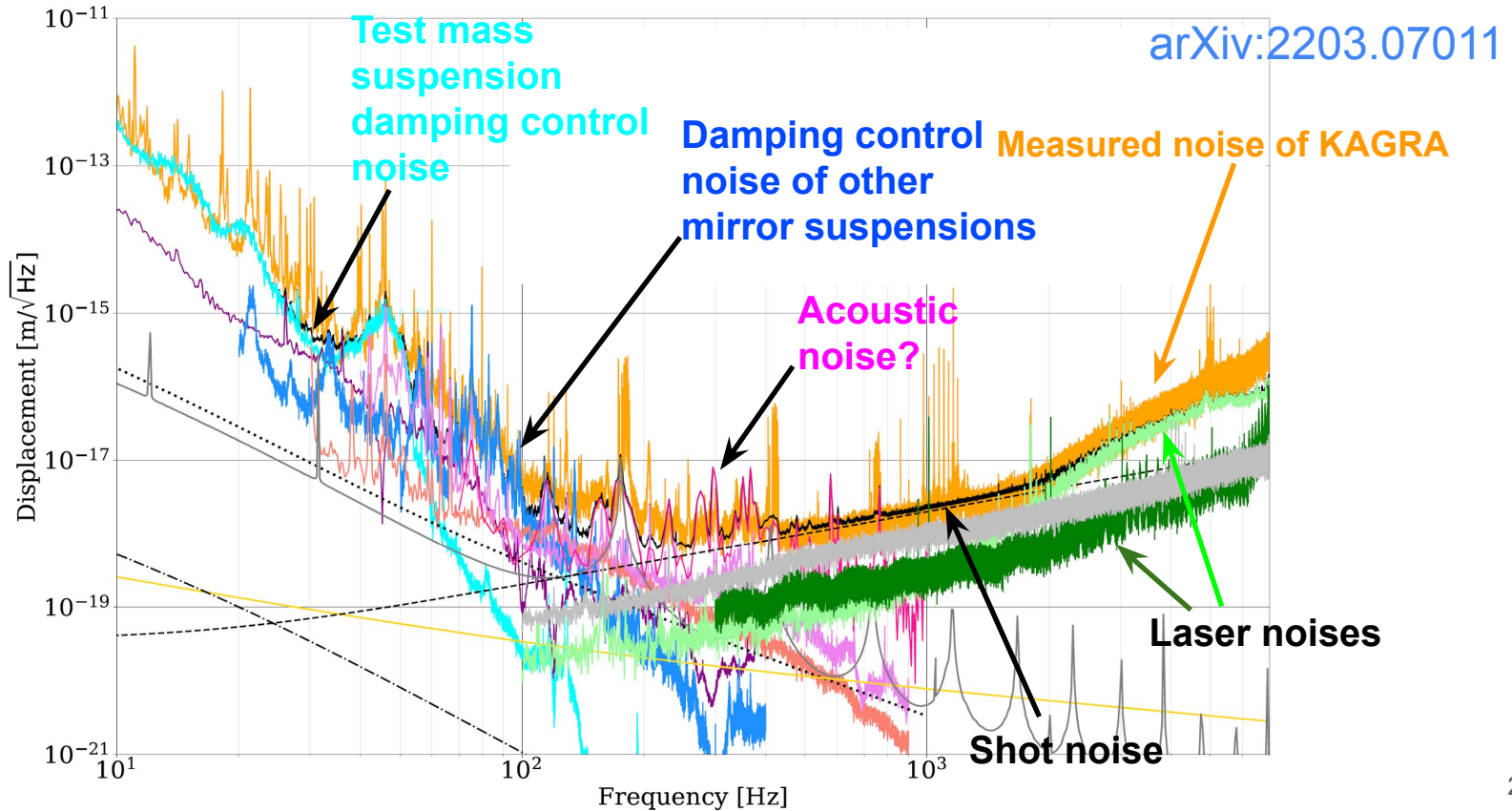

O3GK Noise Budget

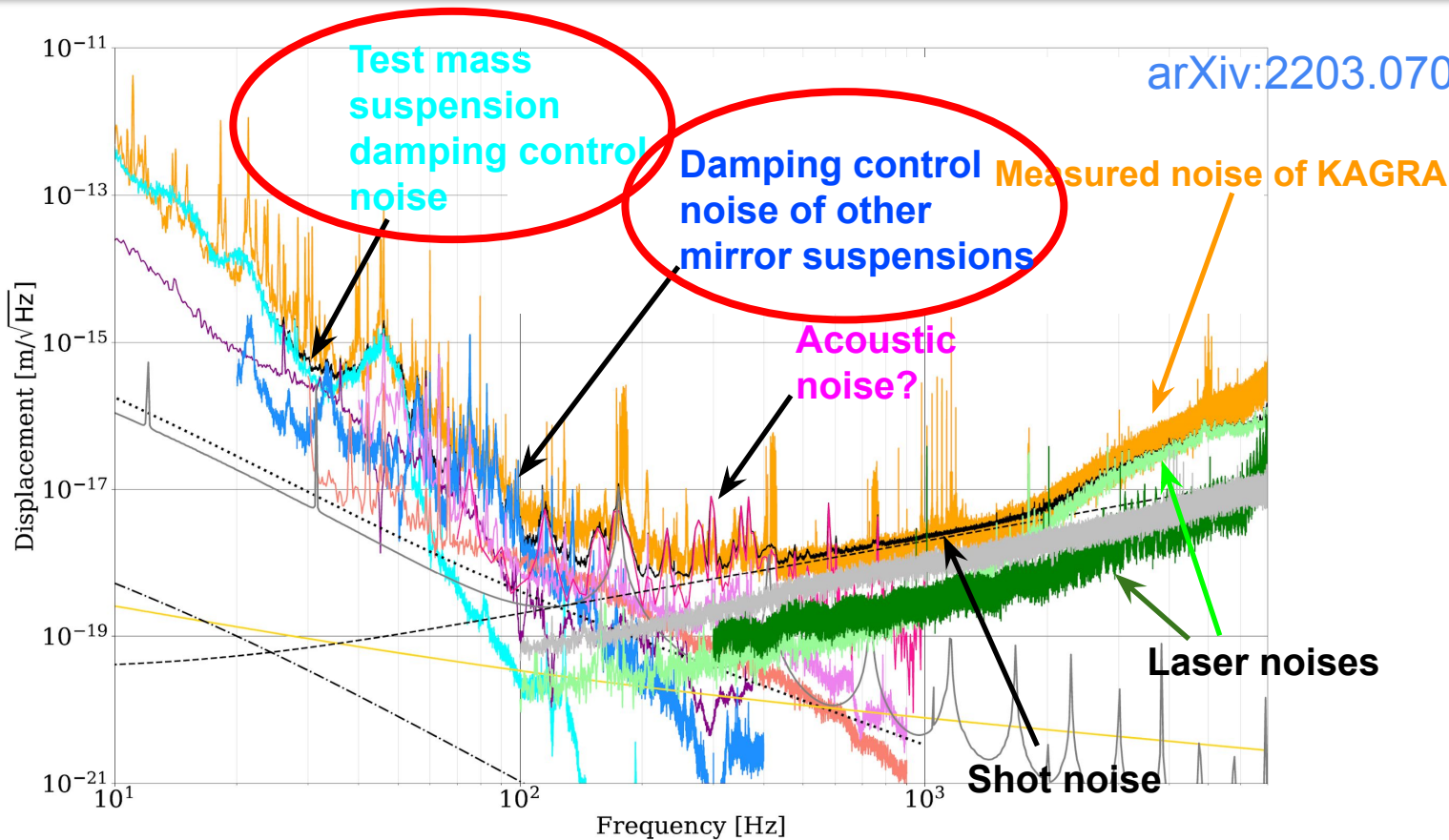

Local damping control

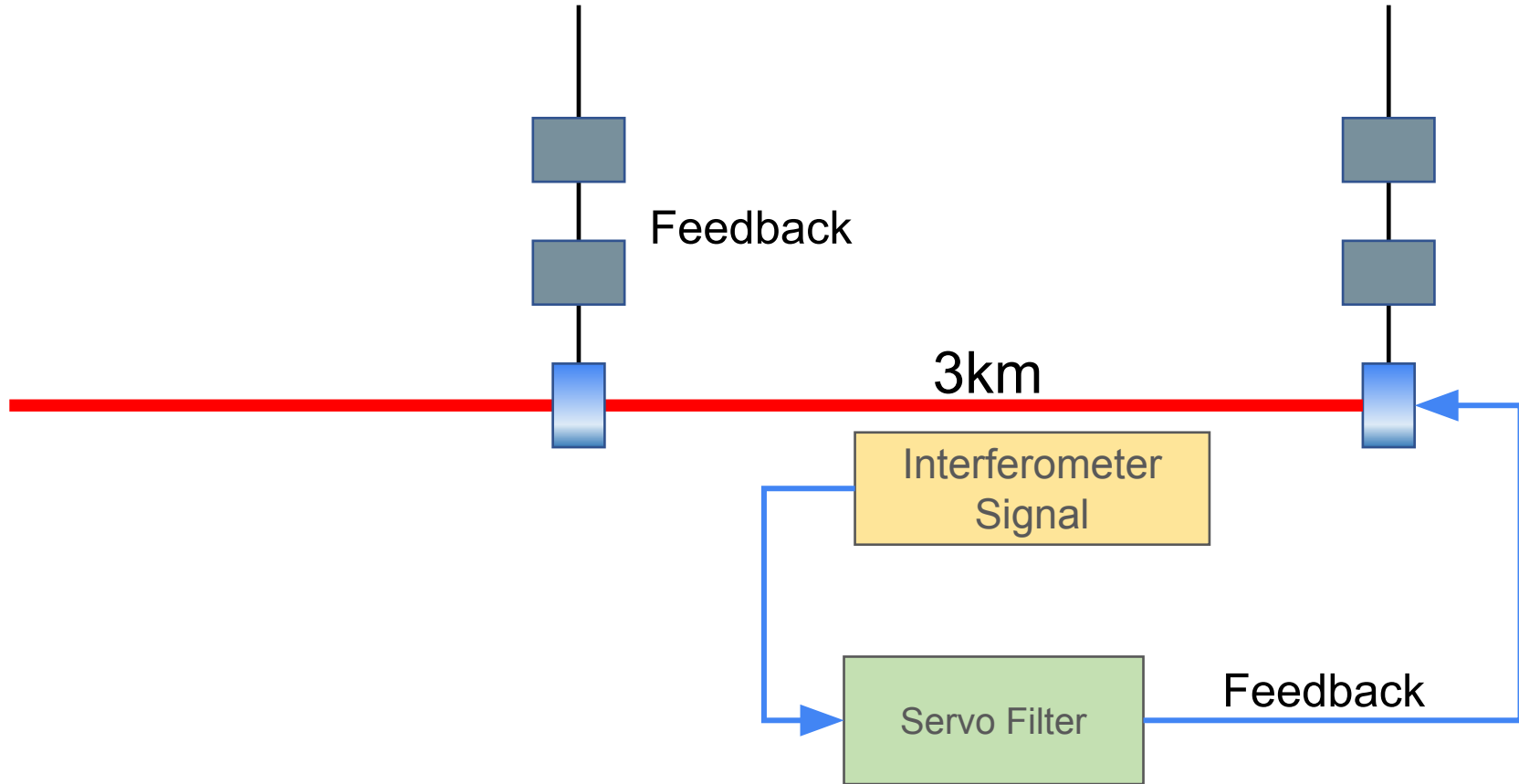

Local damping control

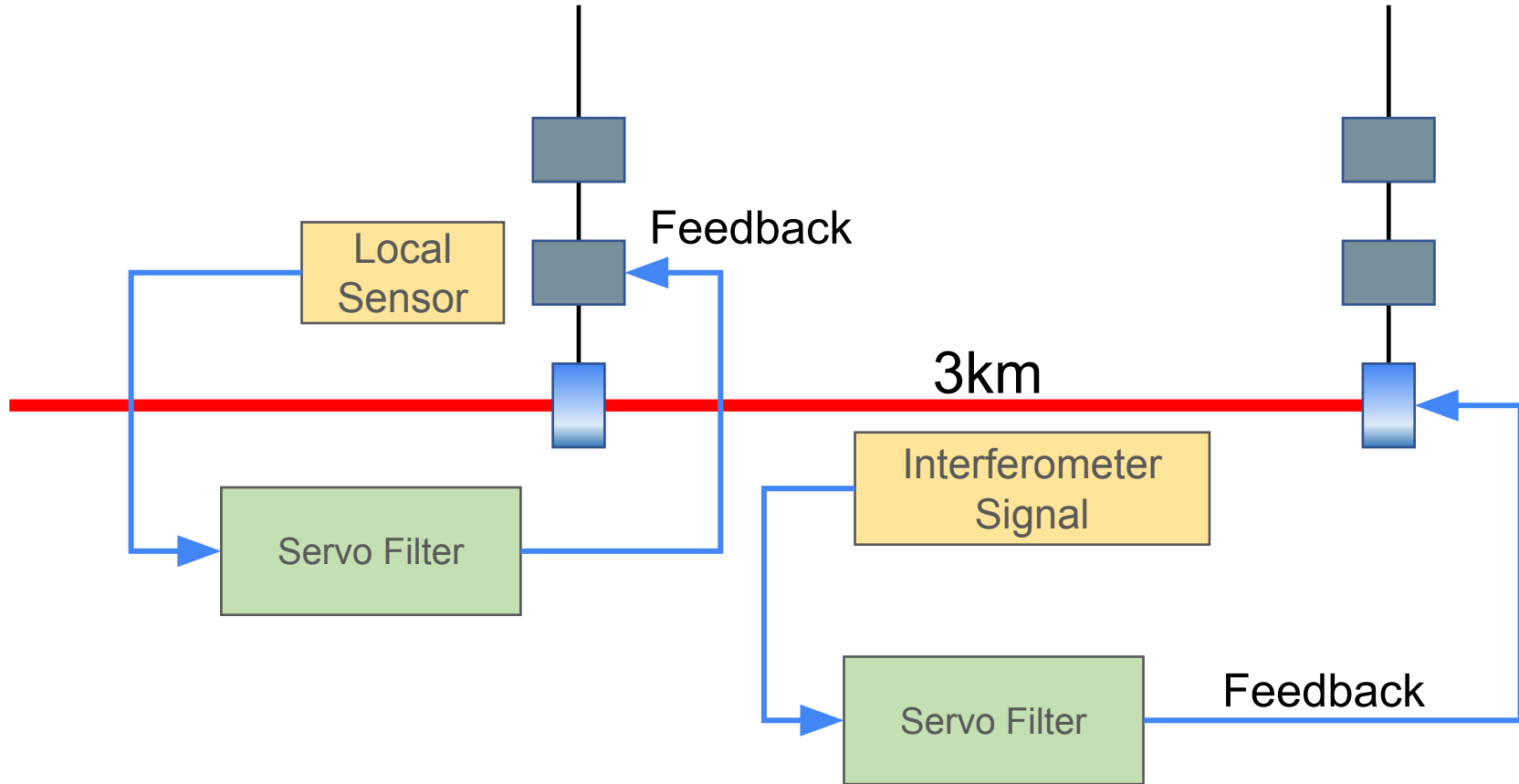

O3GK Noise Budget

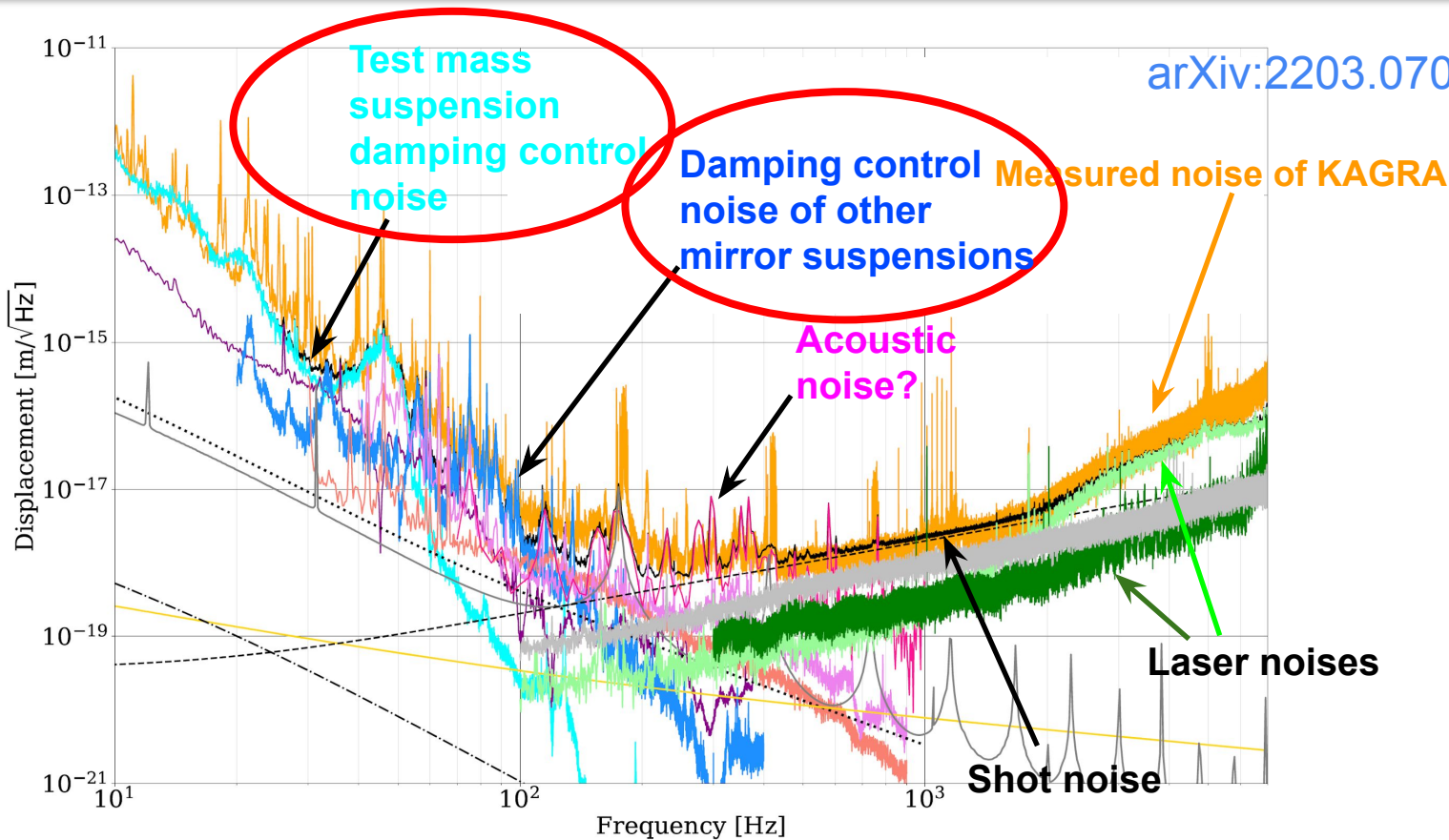

Schematic of KAGRA

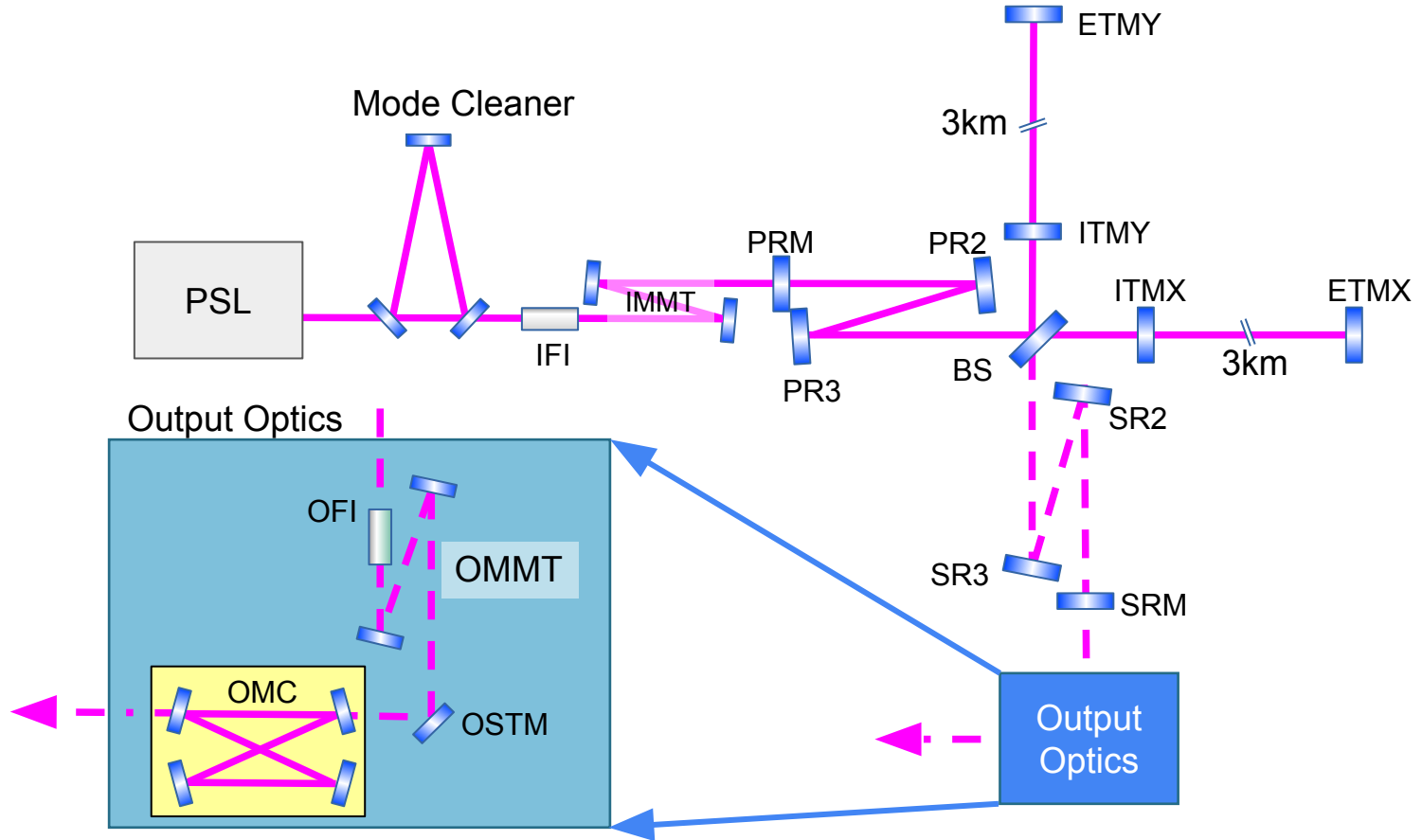

Suspension Upgrades

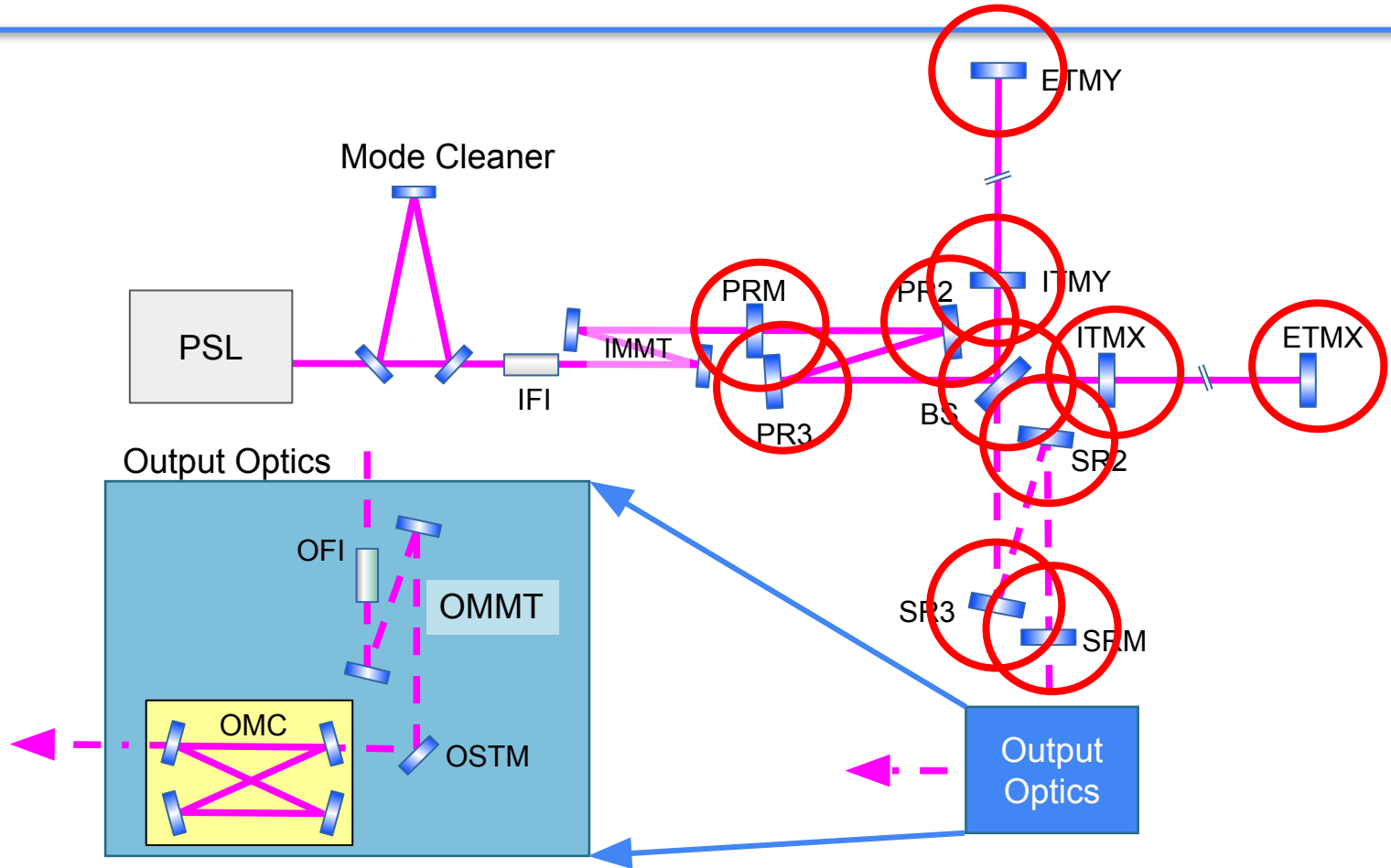

Suspension Upgrades

- Fixed mechanical failures
- Improved various local sensors
 - Accelerometers
 - LVDTs
 - Optical Levers
- Improved actuator balances



Better optimization of damping control filters

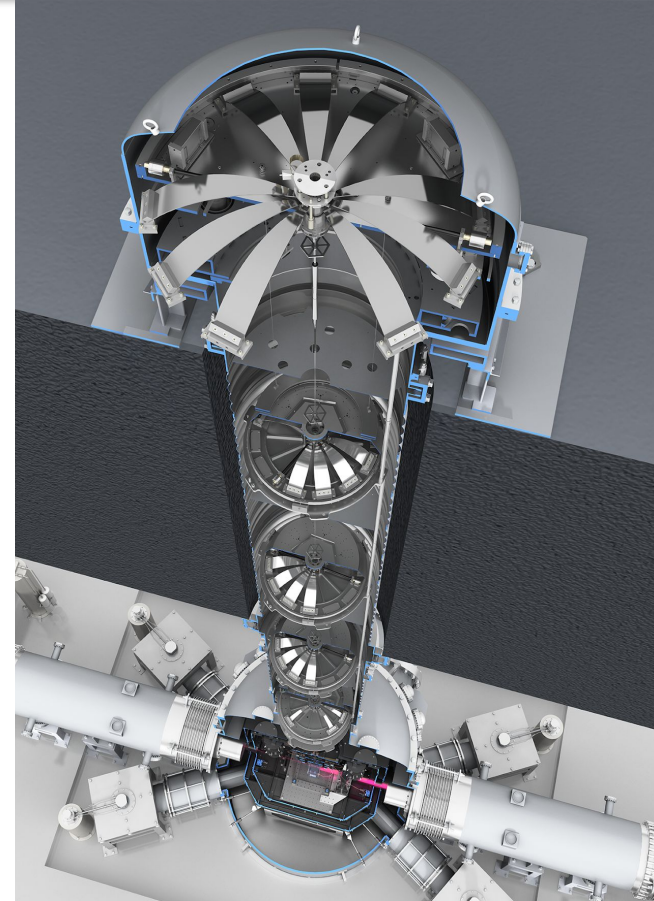

O3GK Noise Budget

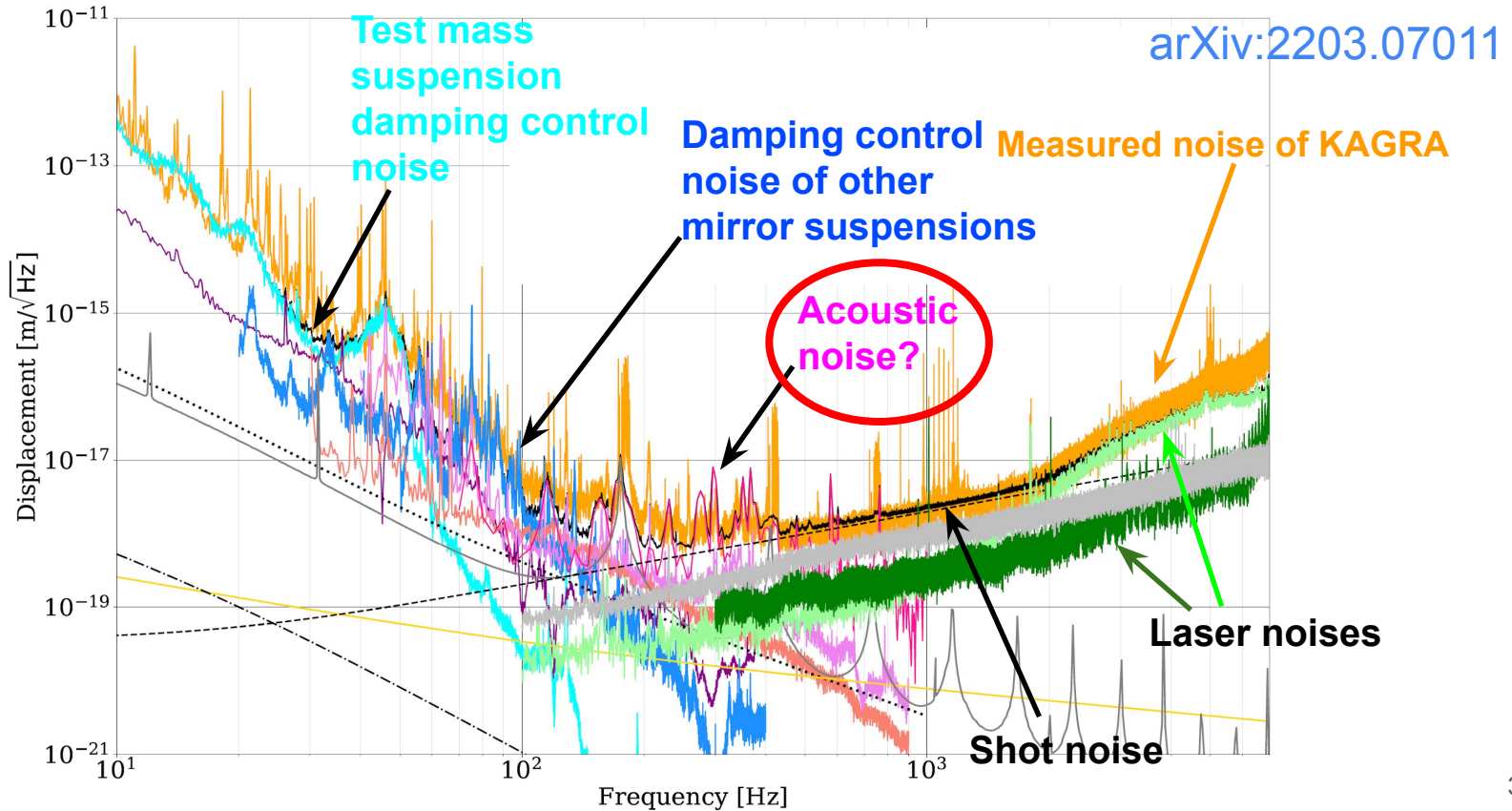

Scattered Light Noises

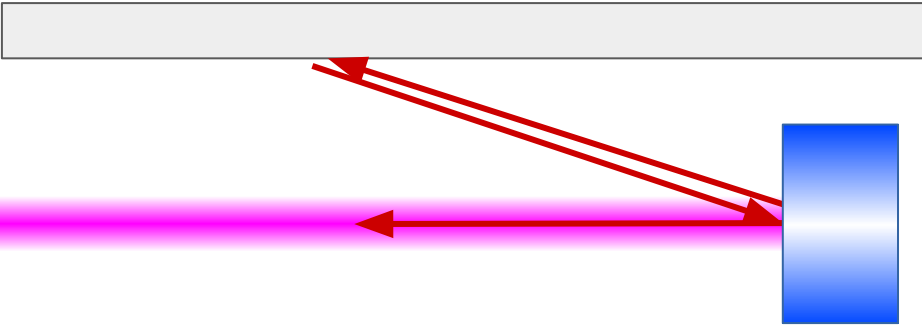

Additional baffles

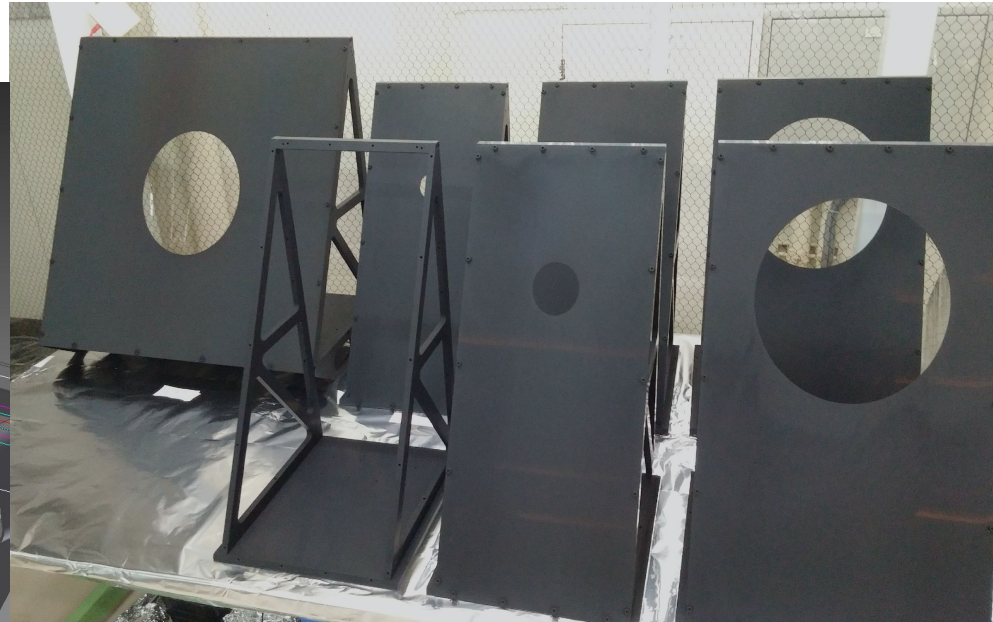
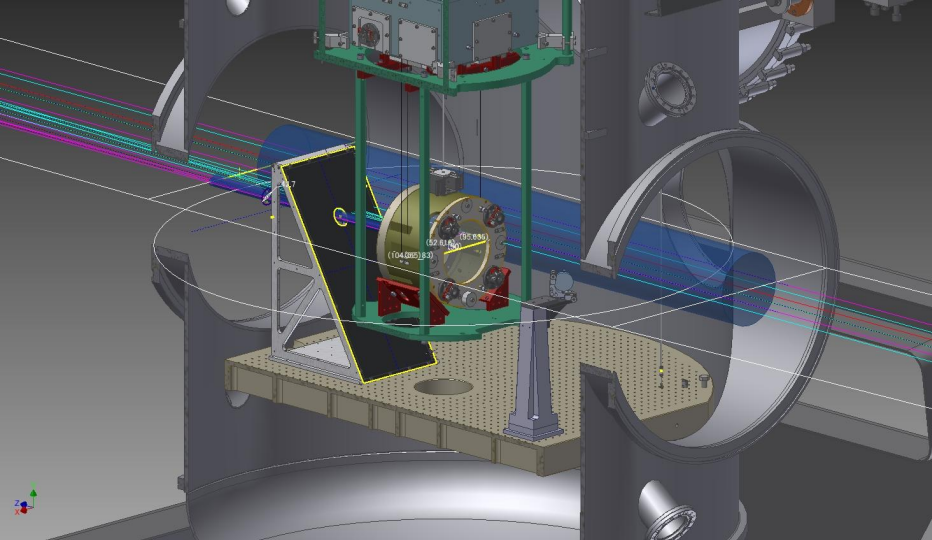

O3GK Noise Budget

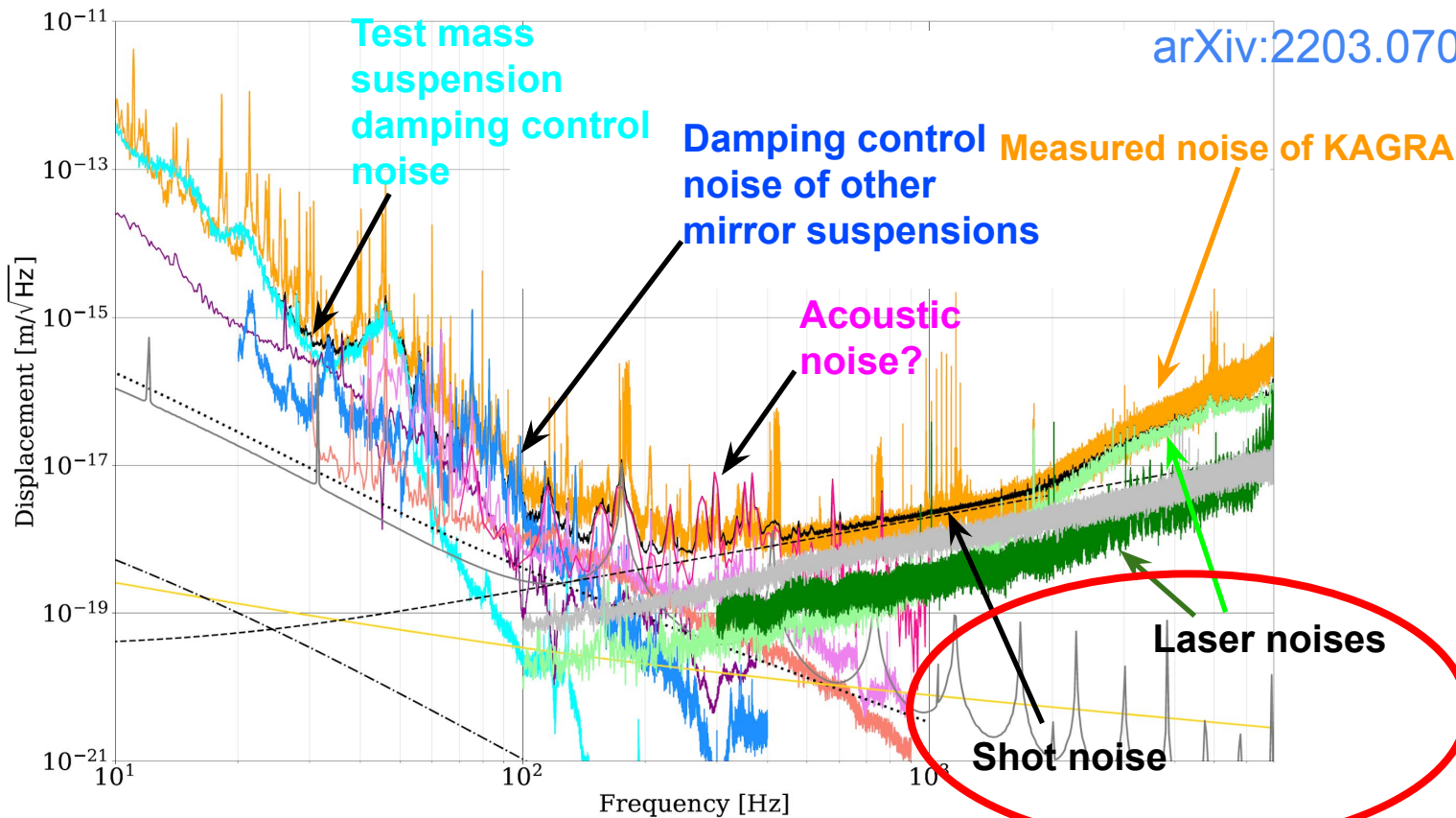

Improving the Shot Noise

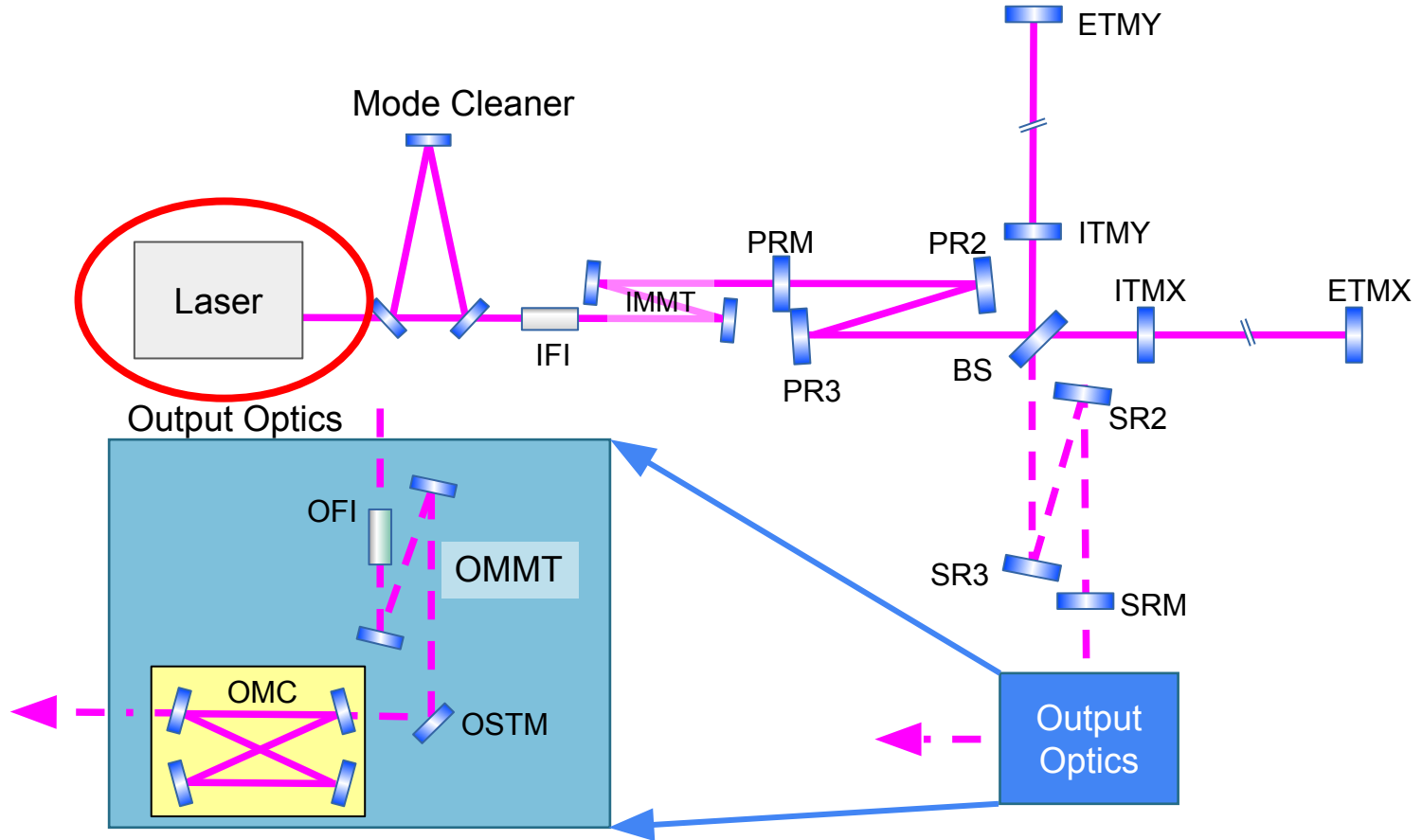

High Power Laser

- 40W -> 60W
 - Only 5W used during O3GK
- Lower intensity noise than the current laser

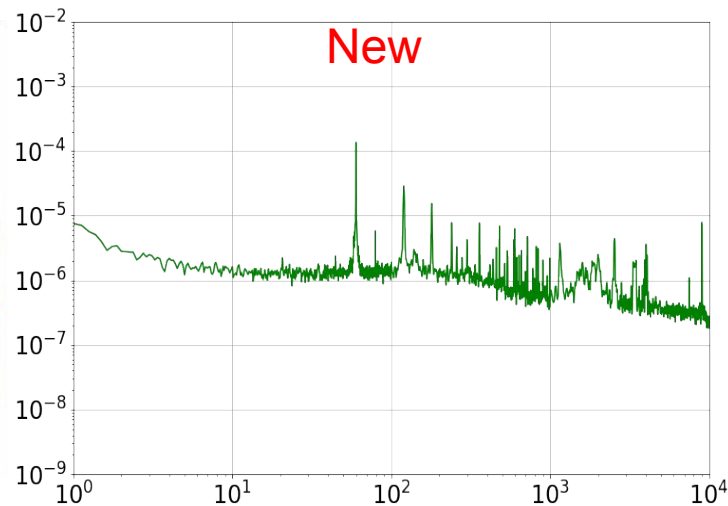
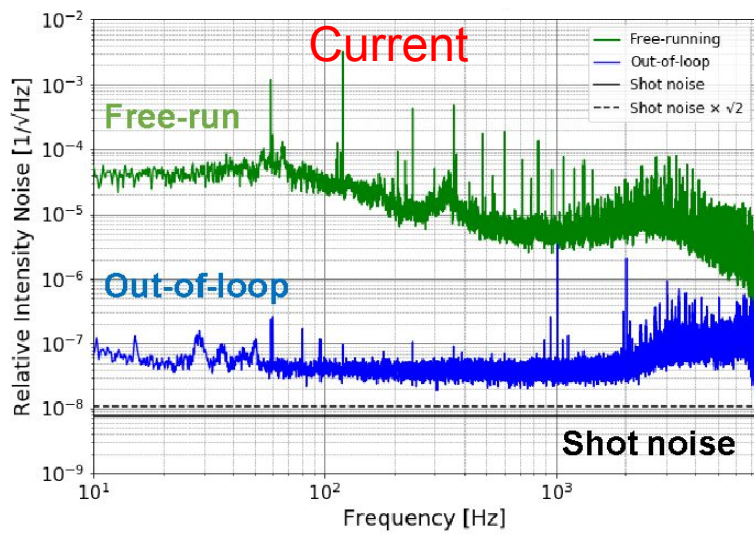
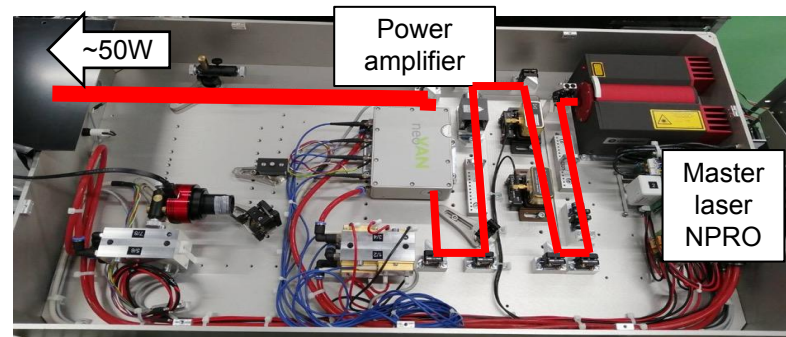

Improving the Shot Noise

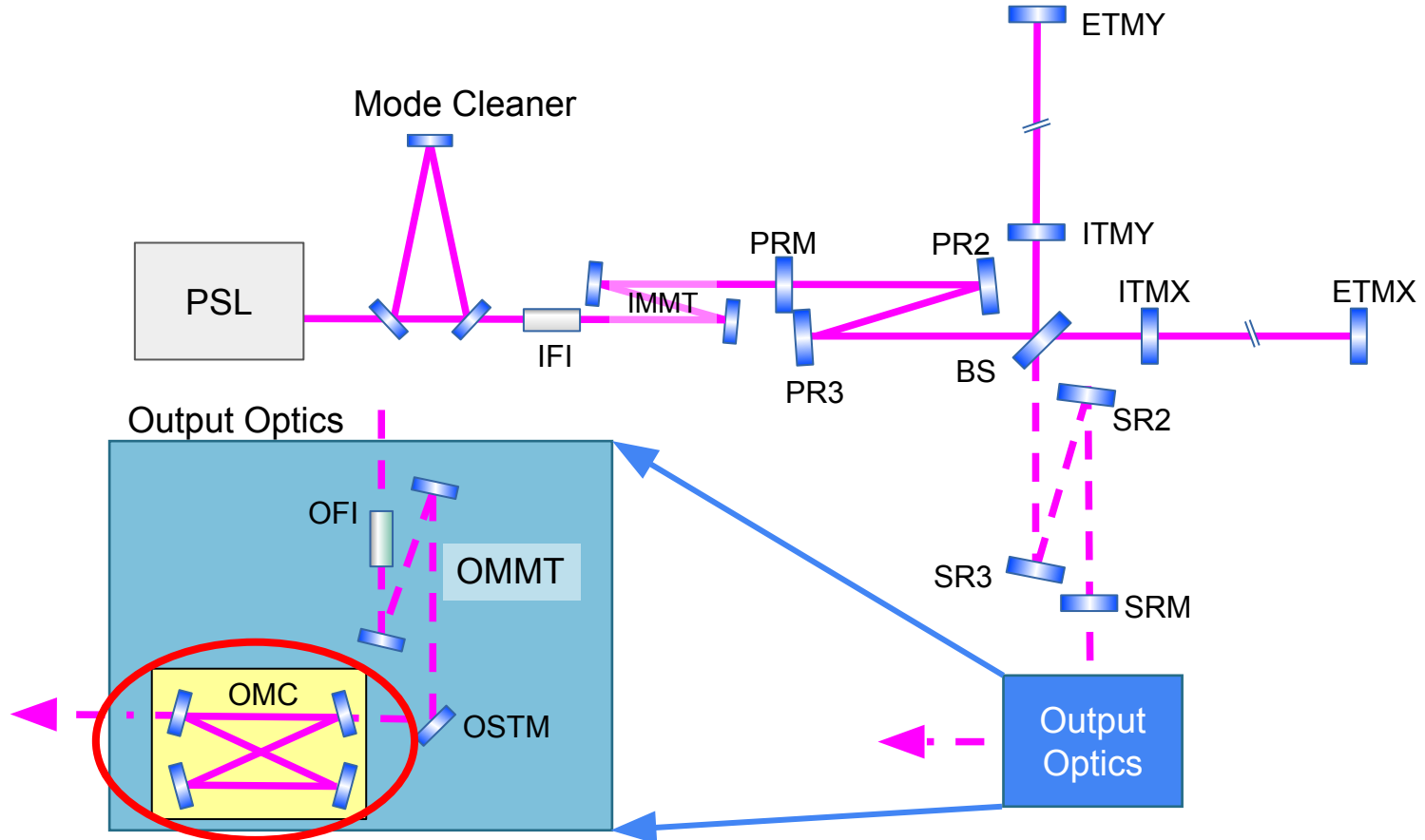

Output Mode Cleaner Upgrade

- Higher transmissivity: 80% → 95%
- Fix the broken DCPD → **Double** the GW signal

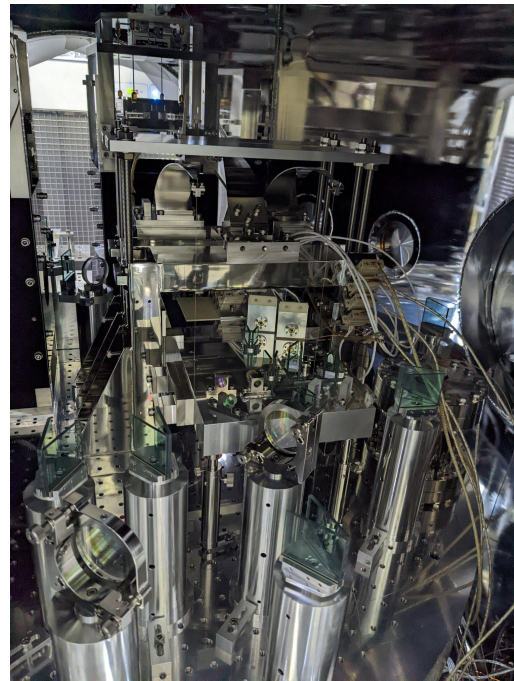
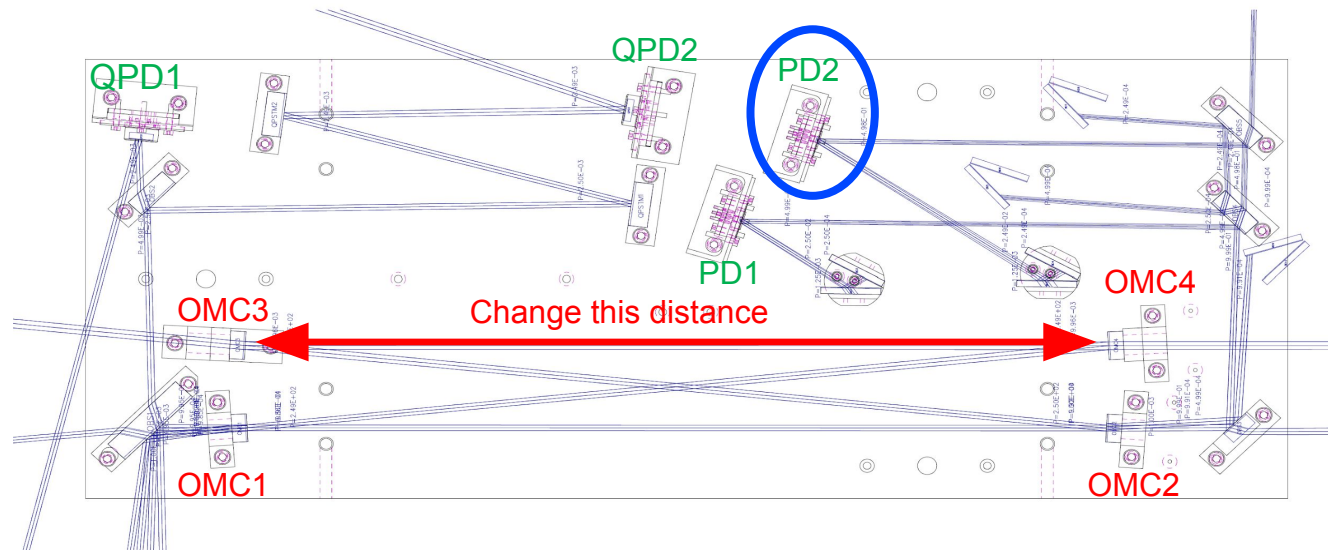

Improving the Shot Noise

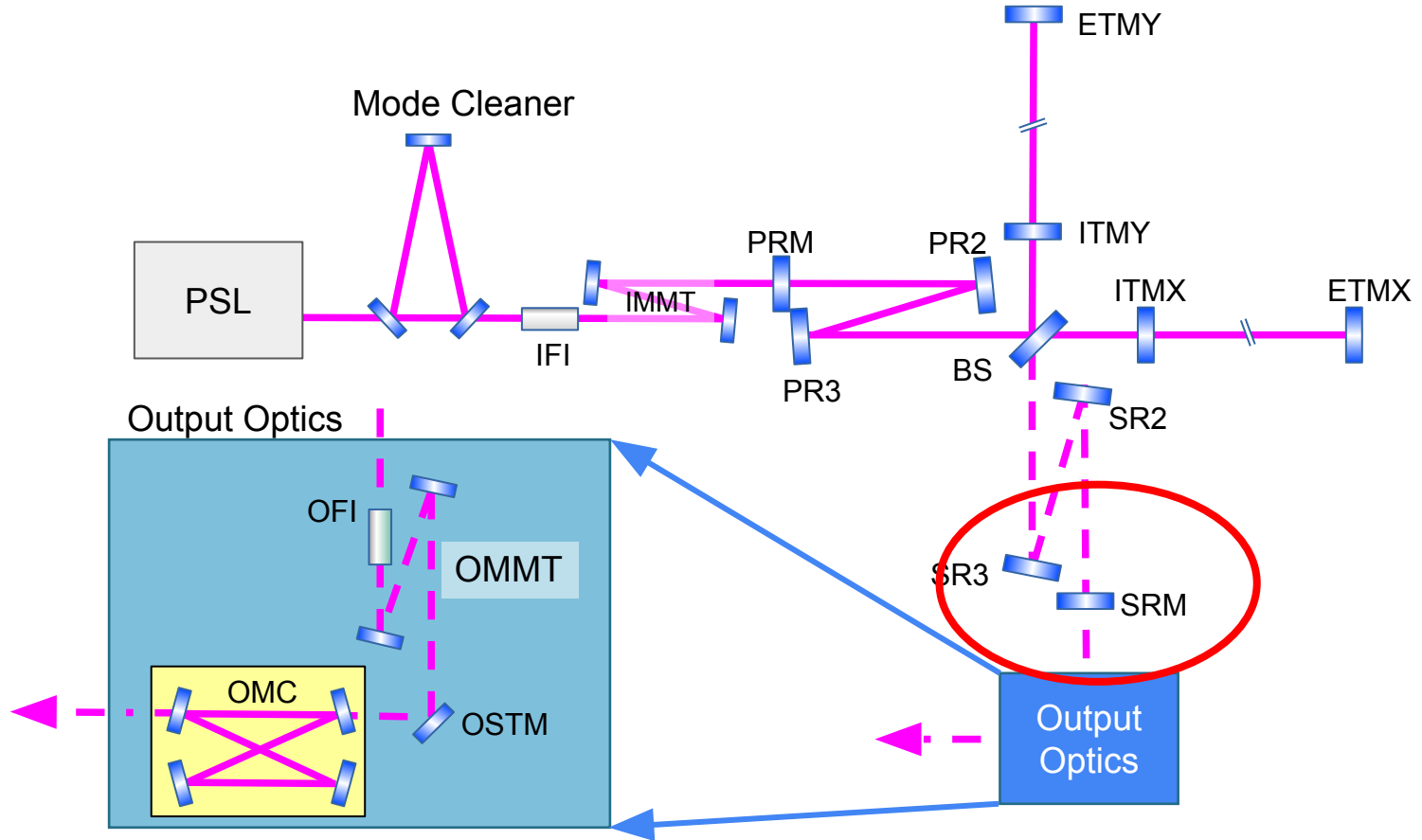

O3GK Interferometer Configuration (PRFPMI)

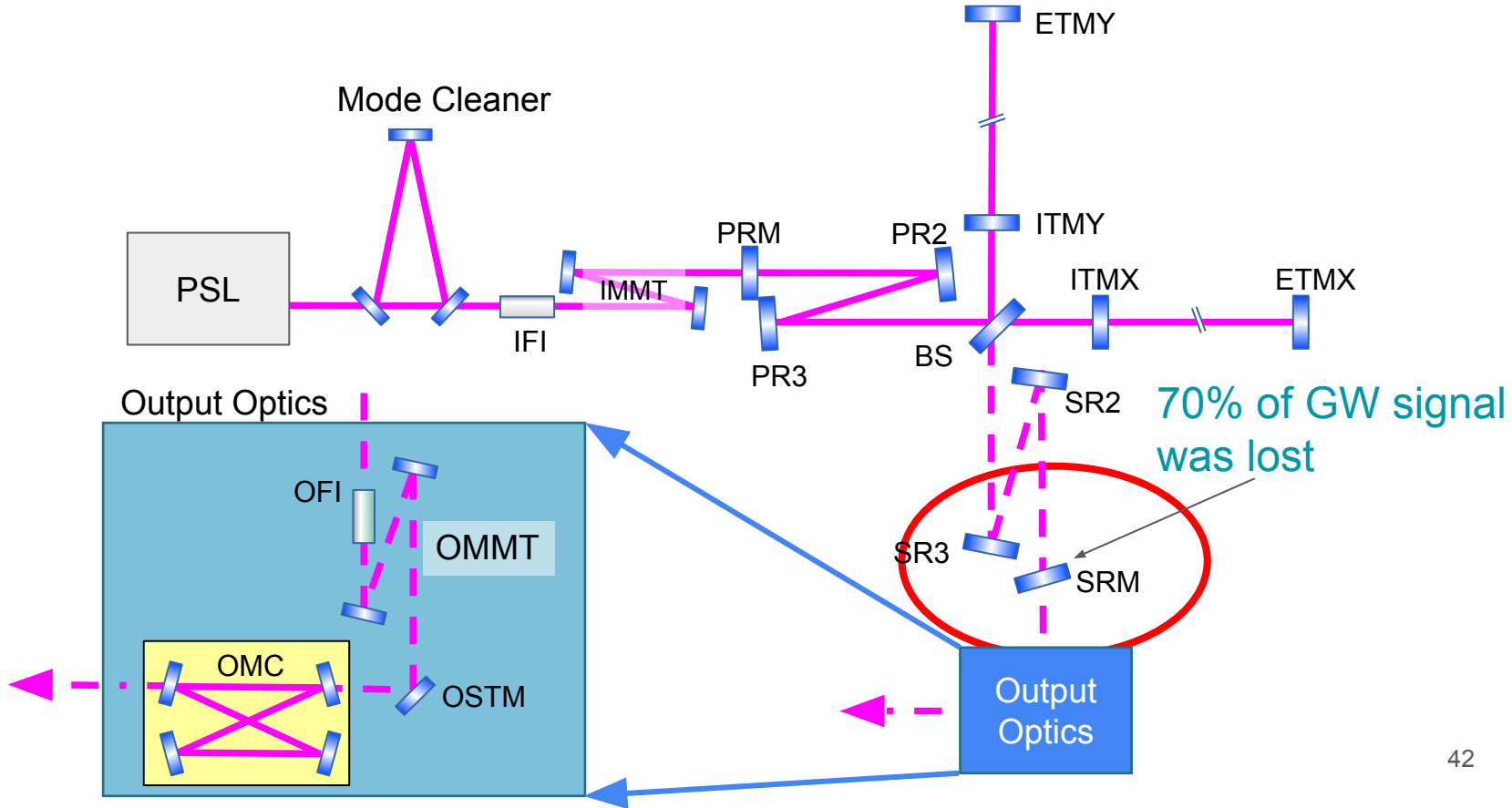

Initial Configuration of O4 (PRFPMI)

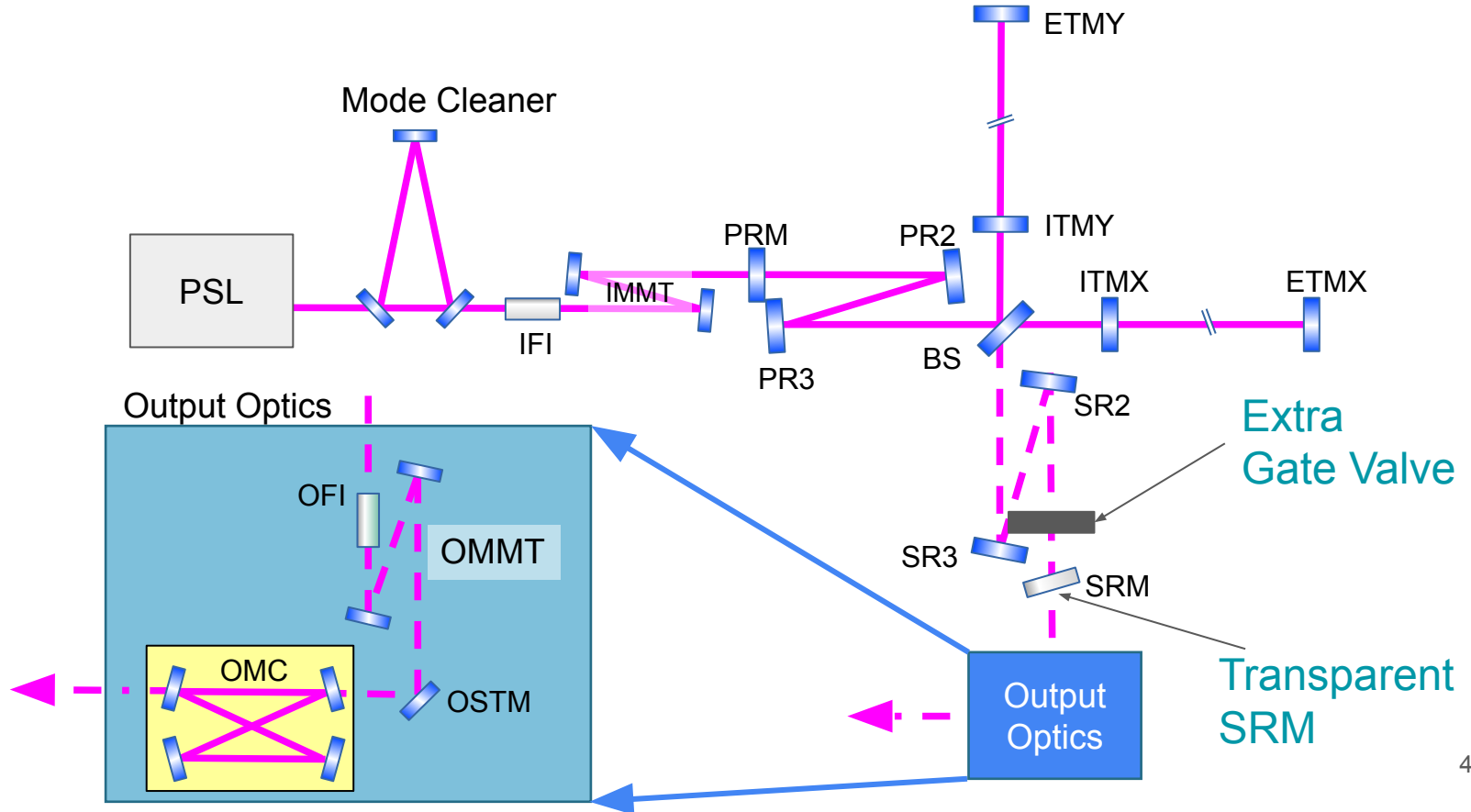

Vacuum & Cryogenic Upgrades

- Additional vacuum pumps
 - 12 more ion-pumps
 - 10 more turbo molecular pumps
- Better vacuum
- Avoid molecular adsorption on mirrors during cooling
- Defrosting heaters

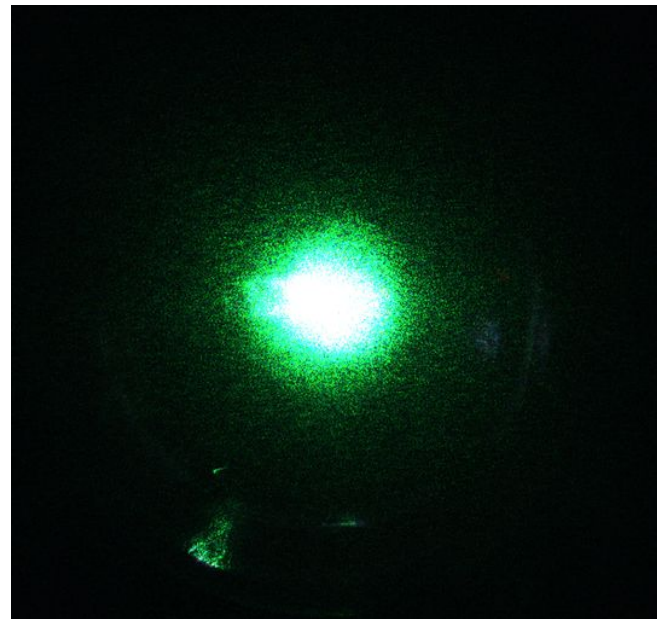

Frosted mirror surface

Schedule towards O4



2022

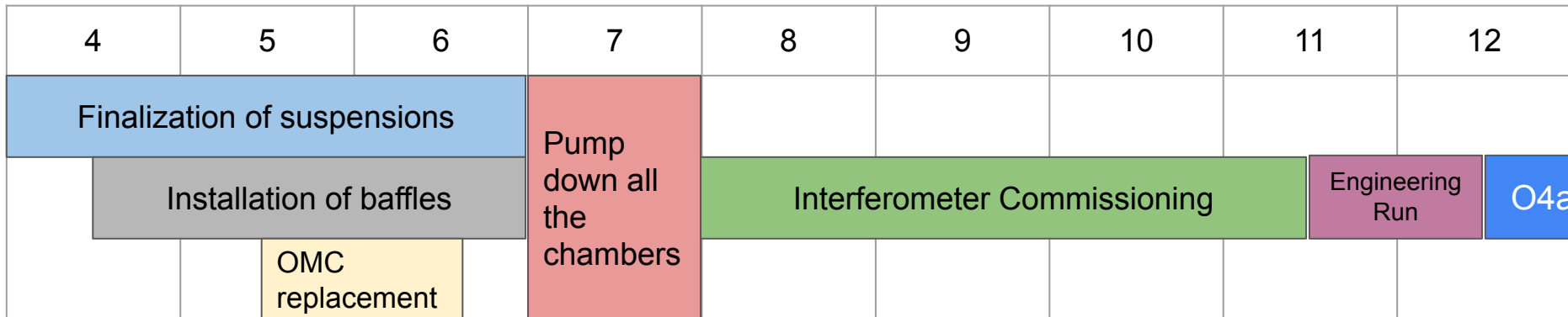

- KAGRA will join O4 from the beginning with about 1Mpc BNS range
- After 1 month, KAGRA will go back to the commissioning mode
- KAGRA will come back to the observation during O4b with an improved sensitivity (~ 10Mpc?)
 - About 3 months of participation in O4b

Possible scenarios for O4 sensitivity

O4a (1-3Mpc)

- Transparent SRM
- 1/3 technical noises

O4b (10-25Mpc)

- Cryogenic operation
- 1/25 to 1/77 technical noise reduction

KAGRA design sensitivities
(128Mpc-153Mpc)

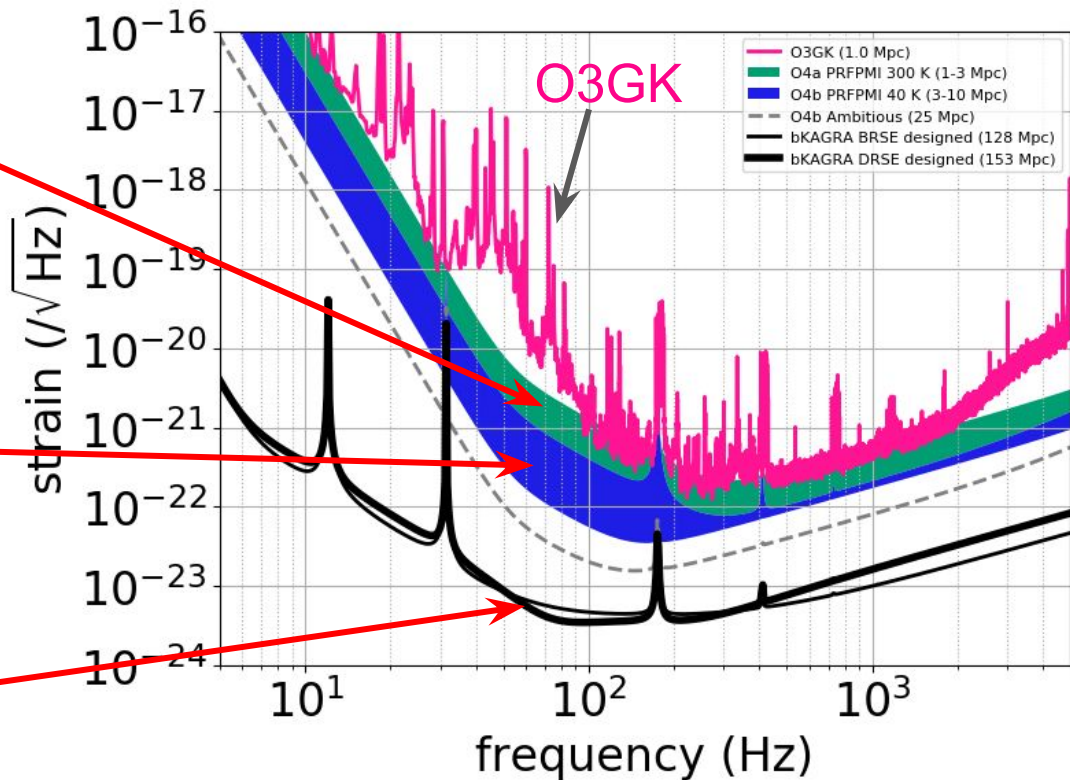

Summary



- KAGRA has been conducting upgrades in various subsystems to fix problems identified during O3GK
- KAGRA plans to join O4 from the beginning with about **1Mpc** BNS range
- KAGRA will leave the observation for improving the sensitivity in the middle of O4
- Sometime during O4b, KAGRA will be back to the observation with an improved sensitivity
 - About **3 months** of participation in O4b
- Possible O4b sensitivity: **10Mpc** (25Mpc for optimistic scenario)

- O4
 - Expect to start 15 Dec 2022.
 - 1 year observing, with 1 month, mid-run commissioning break.
 - Alerts may be released during engineering running that precedes O4.
 - May extend the run if scheduling O5-upgrades makes that viable
 - Will signal in advance if there is an extension
- Detectors' status
 - Scientists, Engineers, Technicians, and Students at LIGO, Virgo and KAGRA working to:
 - Finalize the installation of upgrades;
 - Commission the detectors to reach the expected sensitivities;
 - Some technical uncertainties still remain, which may impact our schedule.
- LVK will continue to review observing run plans quarterly
 - Restart OpenLV(K)EM meetings in preparation for O4

